



FOUNDATIONS  
ADVANCES

**Volume 78 (2022)**

**Supporting information for article:**

**Bond topology of chain, ribbon and tube silicates. Part I. Graph-theory generation of infinite one-dimensional arrangements of  $(\text{TO}_4)^{n-}$  tetrahedra**

**Maxwell Christopher Day and Frank Christopher Hawthorne**

**Appendix G.** Matrix element combinations and associated non-isomorphic chain graphs for vertex connectivities ( ${}^cV_r$ ) where  $\sum r \leq 8$ .

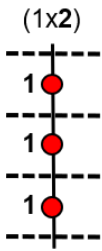
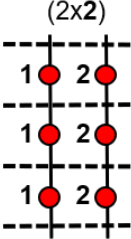
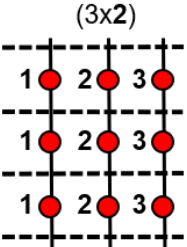
${}^cV_r$		
<b>Rank 1</b>		
${}^0V_{1-8}$	isolated tetrahedra (nesosilicates)	
${}^2V_1$	<p>(1x2)</p> 	
${}^2V_2$	<p>(2x2)</p> 	
${}^2V_3$	<p>(3x2)</p> 	

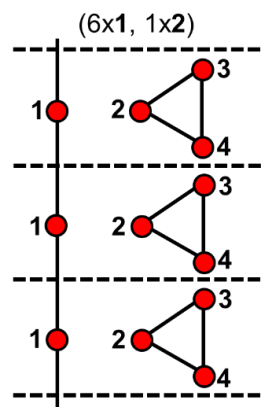
${}^2V_4$ 

(4x2)

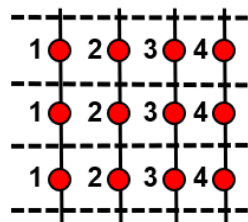
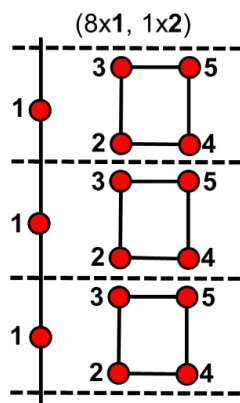
 ${}^2V_5$ 

(6x1, 2x2)

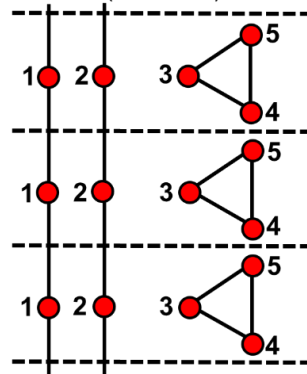

(5x2)

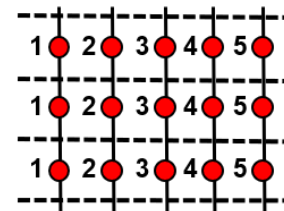

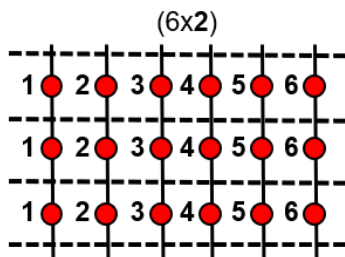
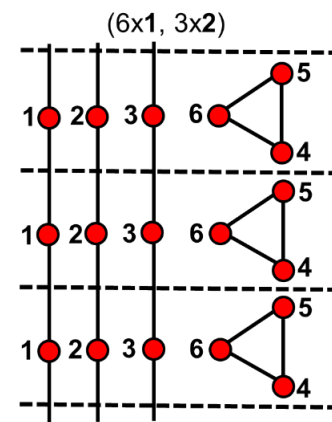
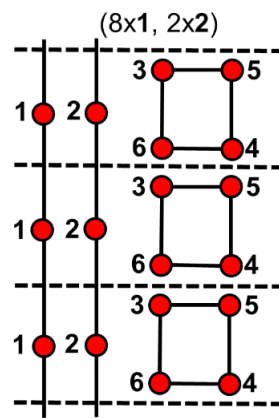
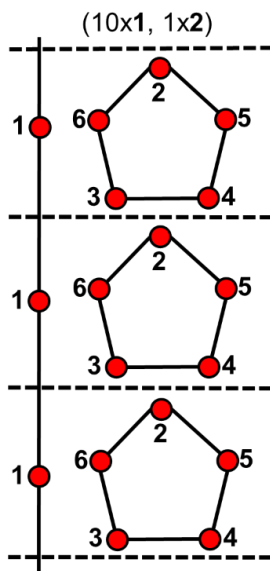
${}^2V_6$ 

${}^2V_7$ 

(12x1, 1x2) a

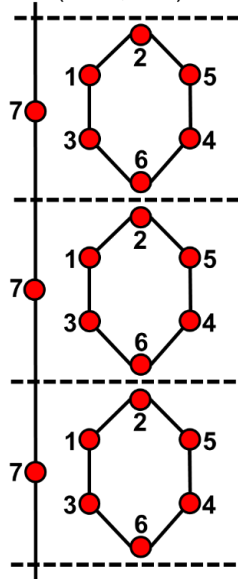

(12x1, 1x2) b

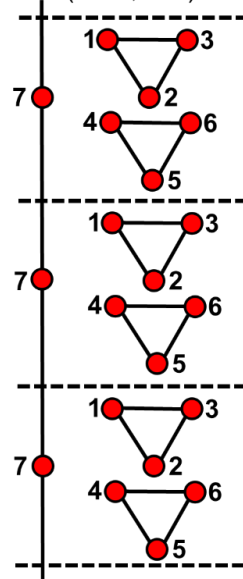

(10x1, 2x2)

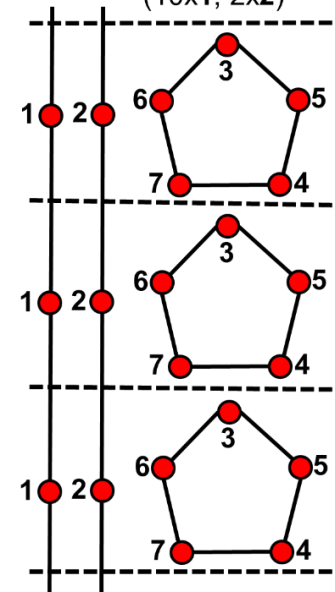

(8x1, 3x2)

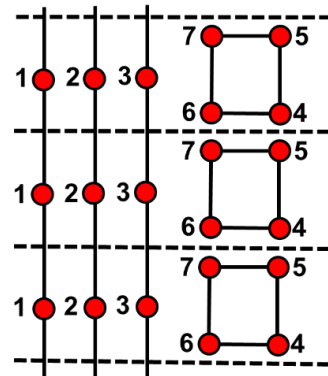

(6x1, 4x2)

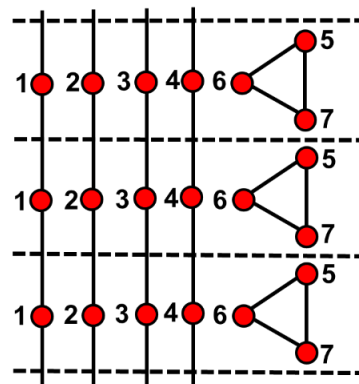

(7x2)

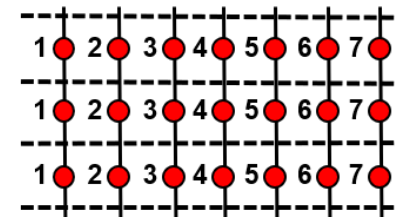

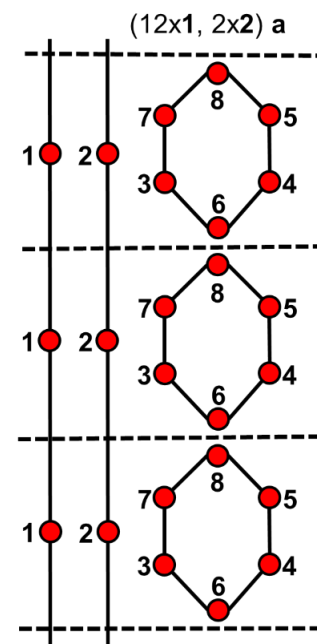
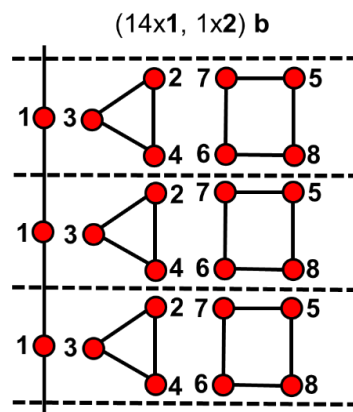
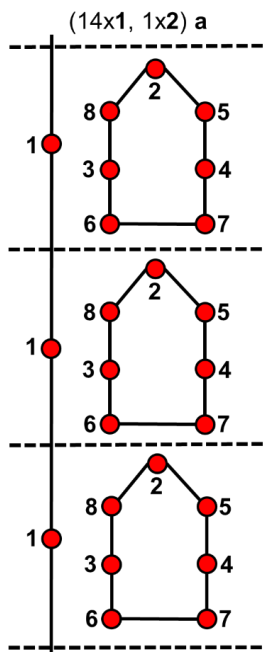
${}^2V_8$ 

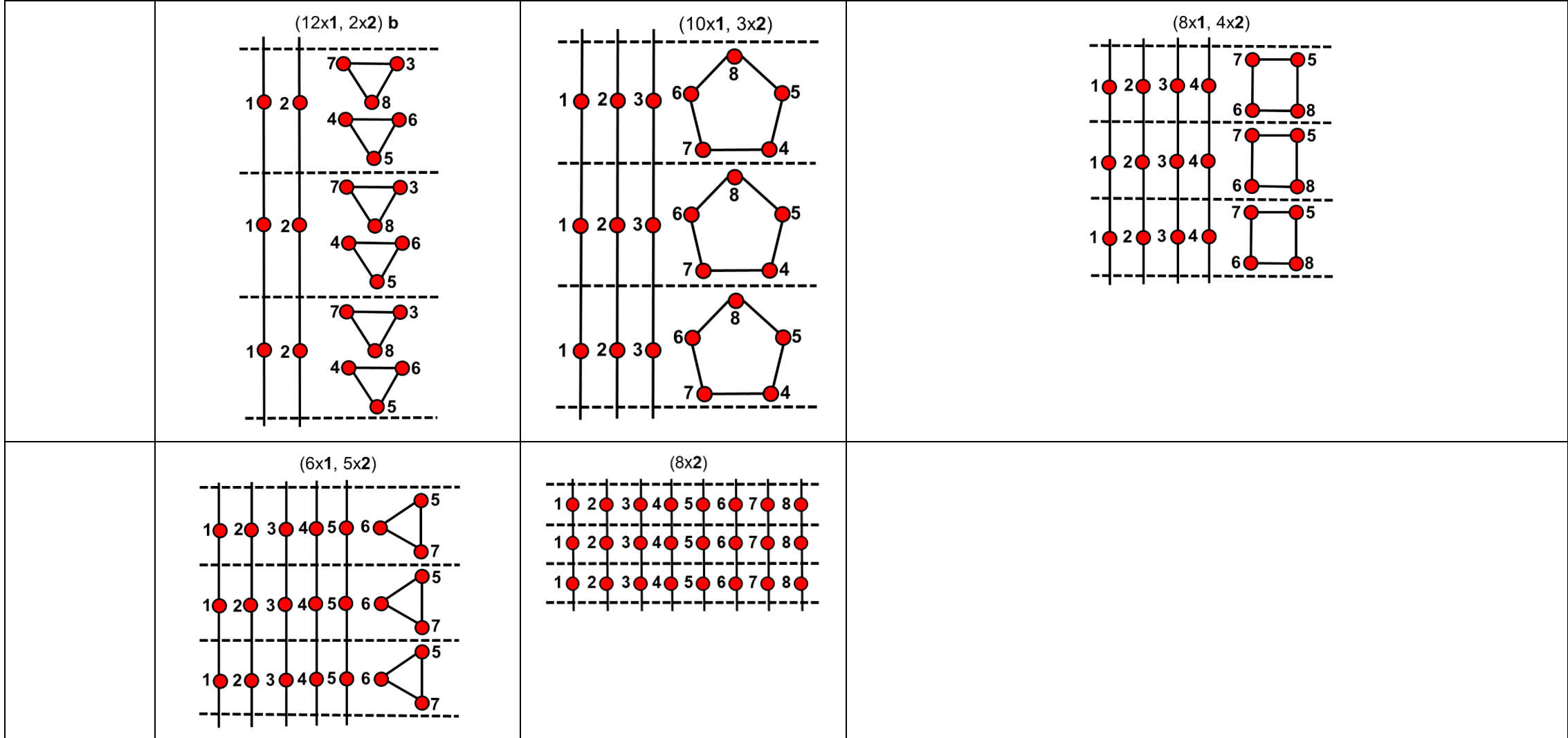

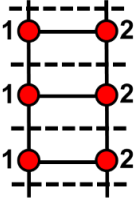
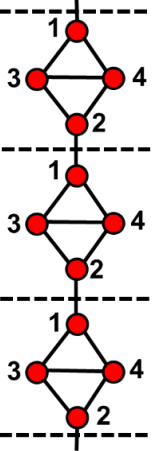
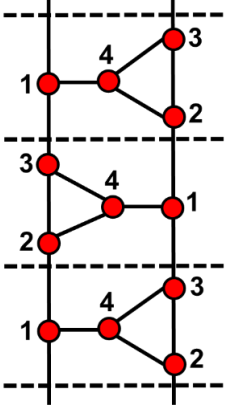
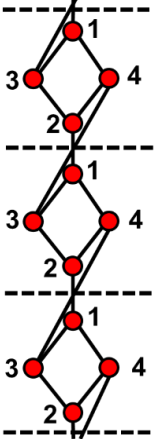
${}^3V_2$	<p>(2x1, 2x2)</p> 		
${}^3V_4$	<p>(12x1) a</p> 	<p>(12x1) b</p> 	<p>(12x1) c</p> 



(12x1) d

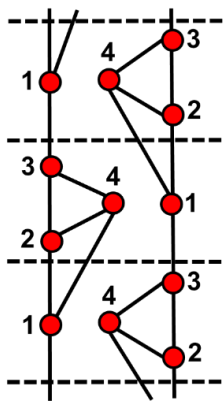

(12x1) e

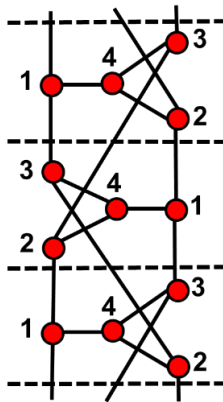

(12x1) f

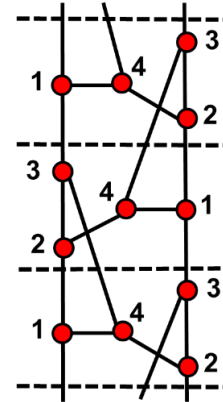

(12x1) g

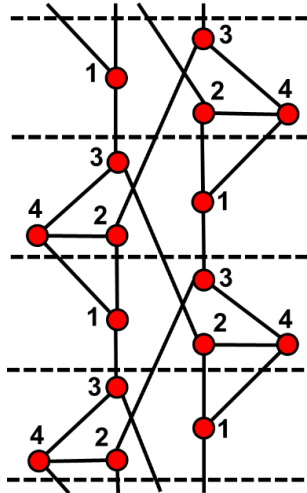

(12x1) h

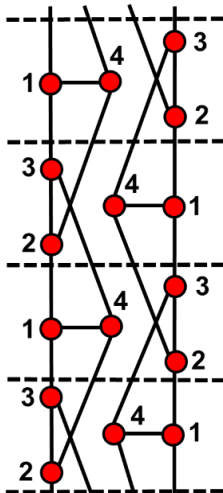

(12x1) i

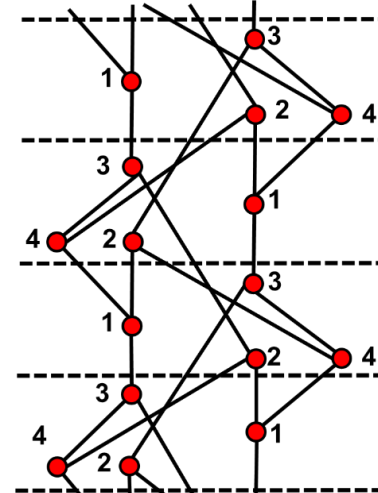

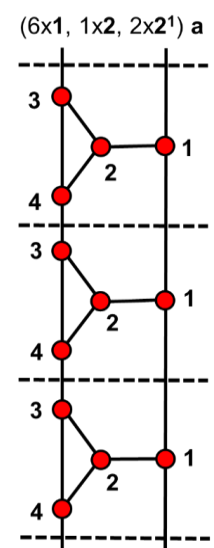
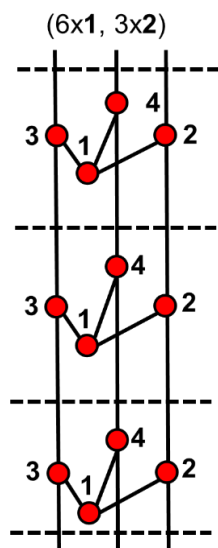
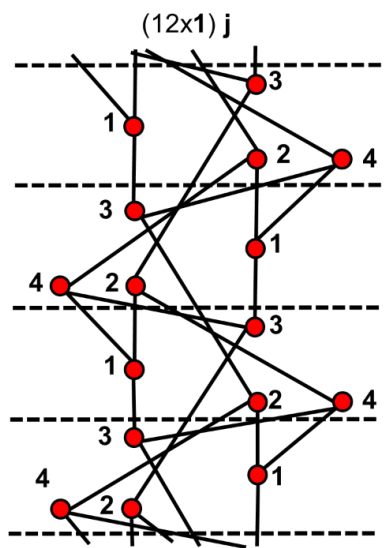

(6x1, 1x2, 2x2<sup>1</sup>) b

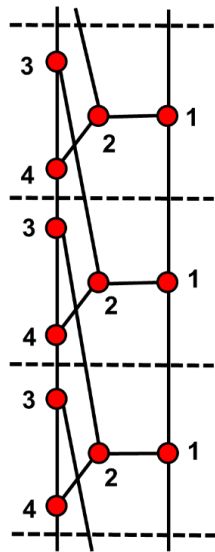

(6x1, 1x2, 2x2<sup>1</sup>) c

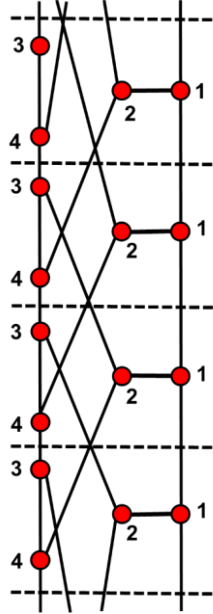

(6x1, 1x2, 2x2<sup>2</sup>) a

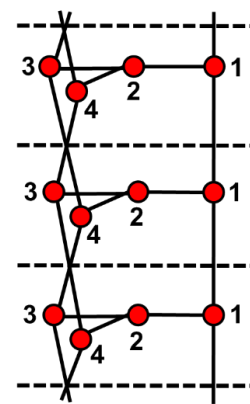

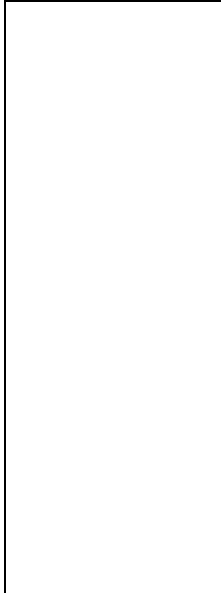

(6x1, 1x2, 2x2<sup>2</sup>) b

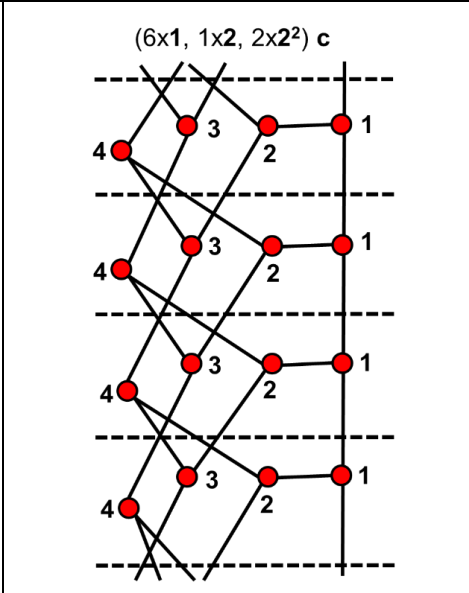
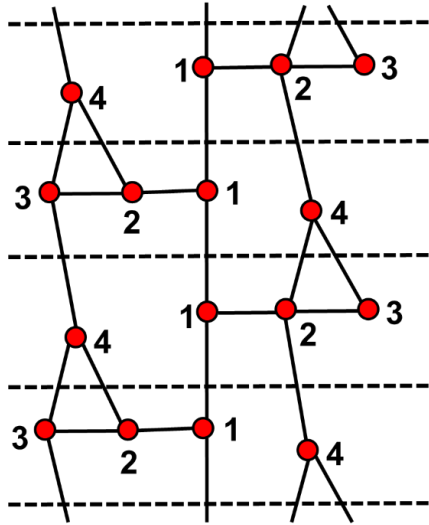

(6x1, 1x2, 2x2<sup>2</sup>) c

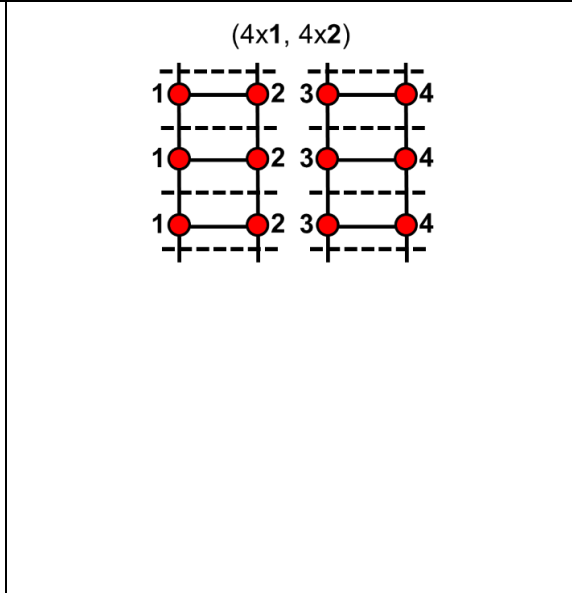
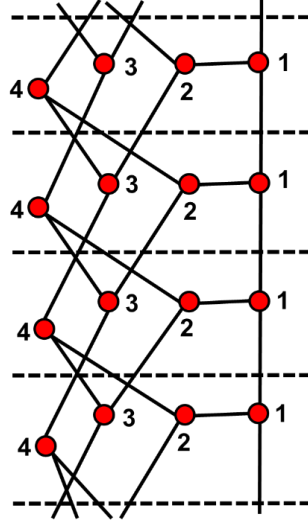

(4x1, 4x2)

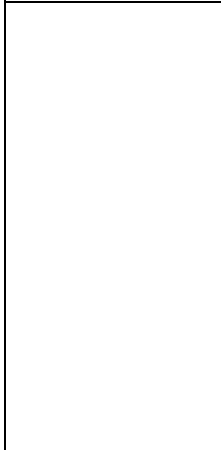
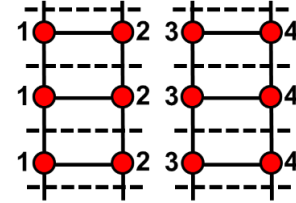

(4x1, 2x2, 2x2<sup>1</sup>)

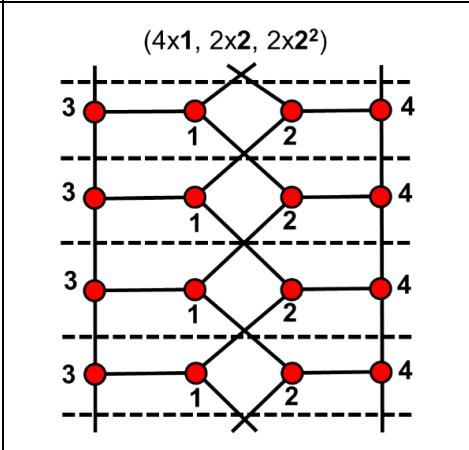
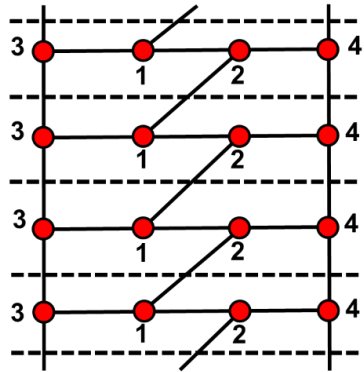

(4x1, 2x2, 2x2<sup>2</sup>)

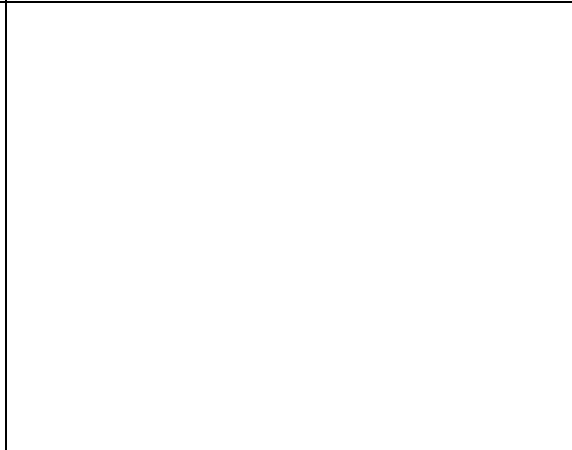
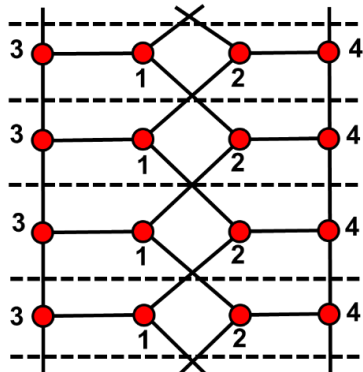

(4x1, 4x2<sup>1</sup>) a

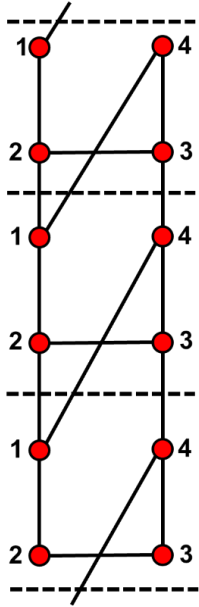

(4x1, 4x2<sup>1</sup>) b

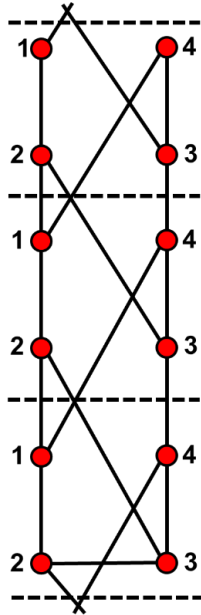

(4x1, 2x2<sup>1</sup>, 2x2<sup>2</sup>) a

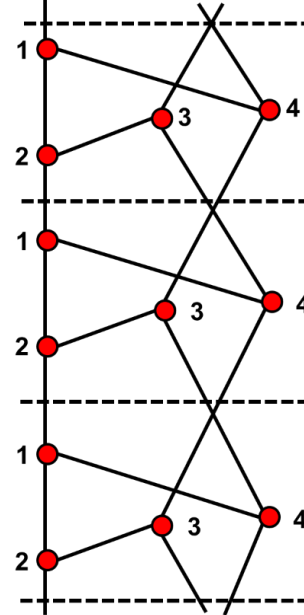

(4x1, 2x2<sup>1</sup>, 2x2<sup>2</sup>) b

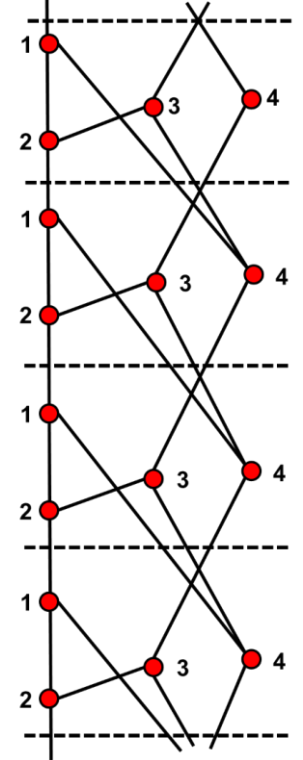

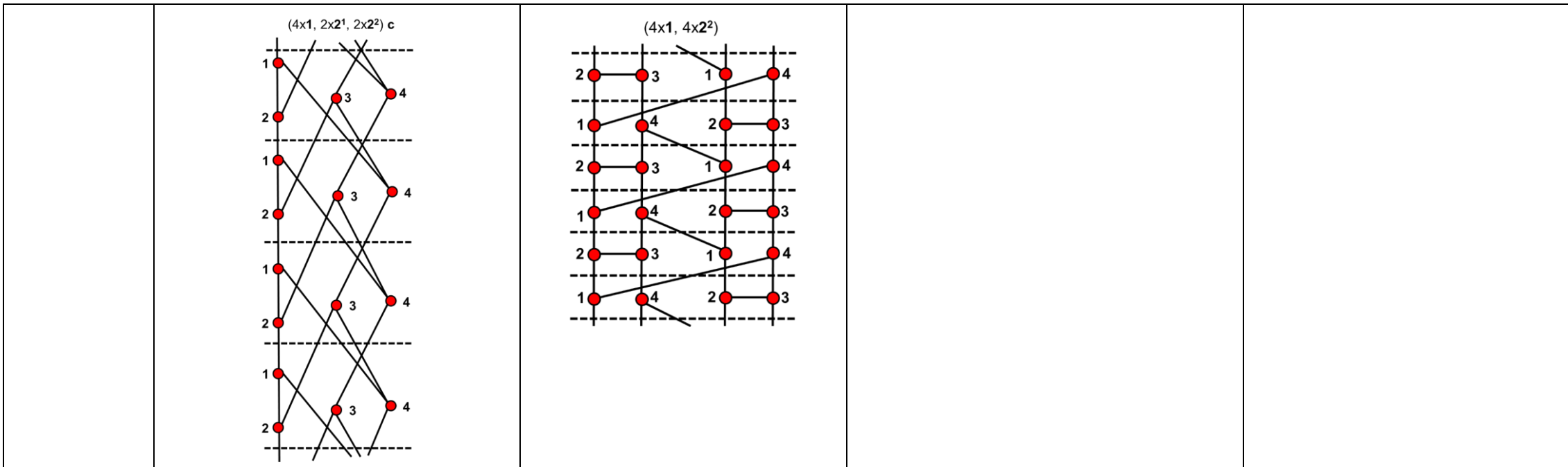

${}^3V_6$	NG
-----------	----

${}^3V_8$	NG
-----------	----

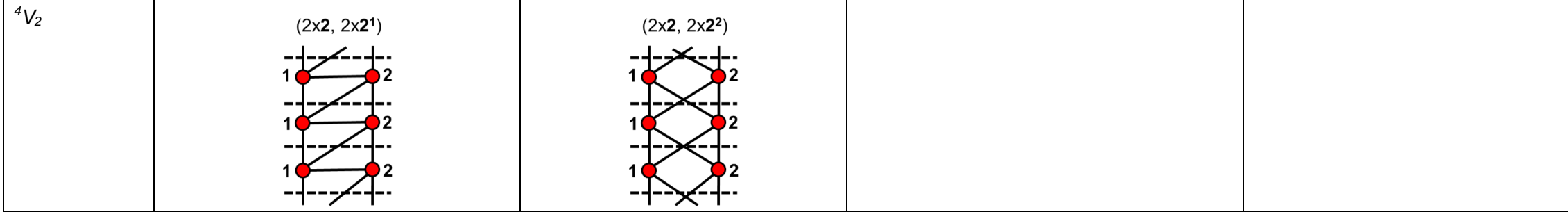

${}^4V_3$ 

(6x1, 3x2) a

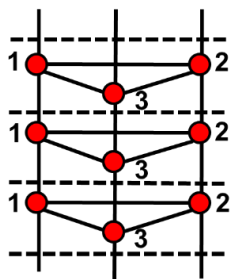

(6x1, 3x2) b

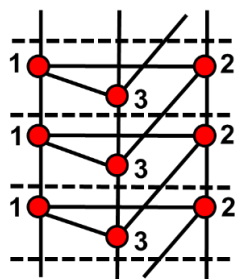

(6x1, 3x2) c

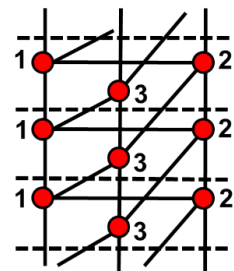

(6x1, 3x2) d

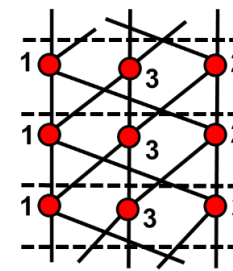

(2x2, 4x2<sup>1</sup>)

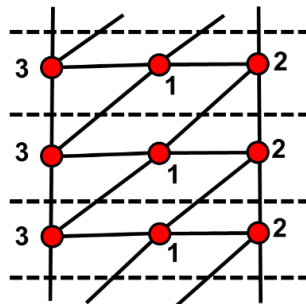

(2x2, 2x2<sup>1</sup>, 2x2<sup>2</sup>)

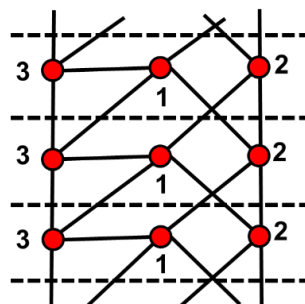

(2x2, 4x2<sup>2</sup>)

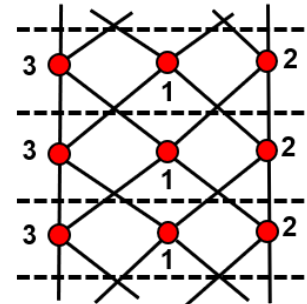

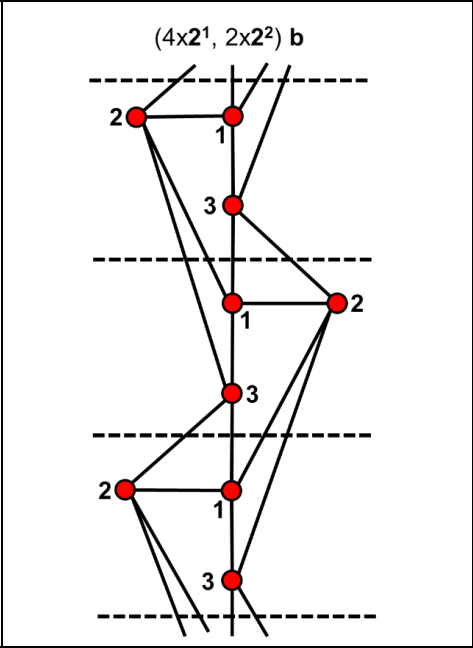
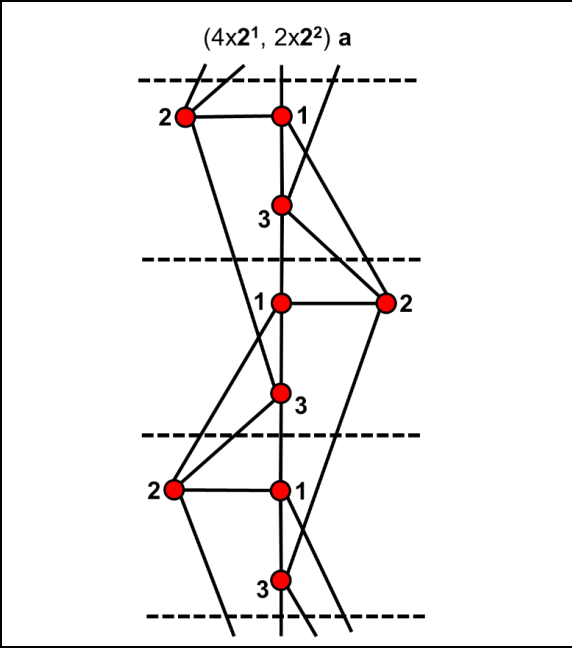
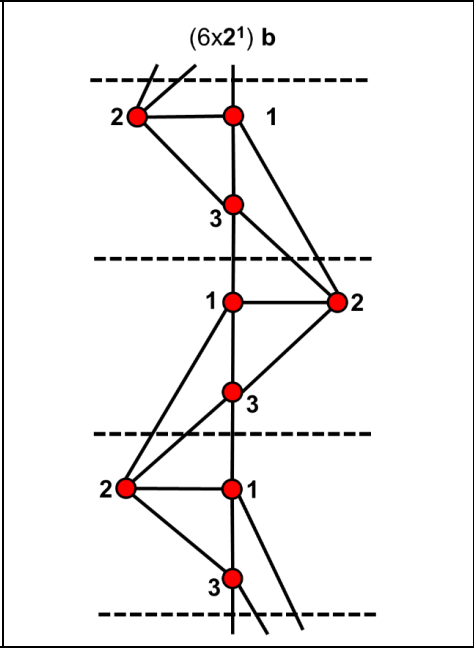
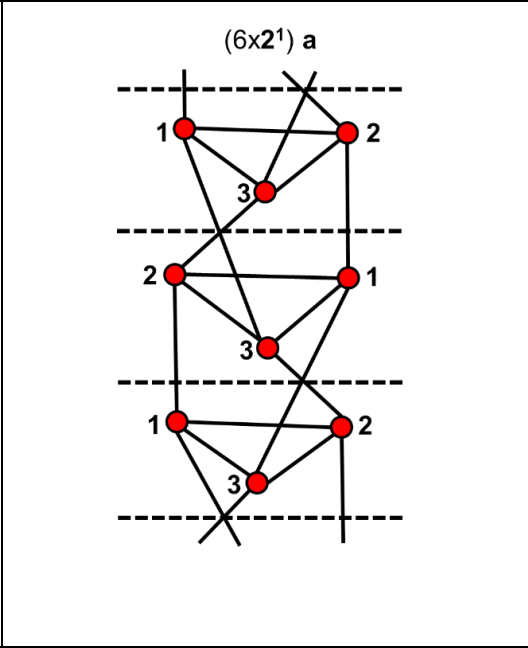
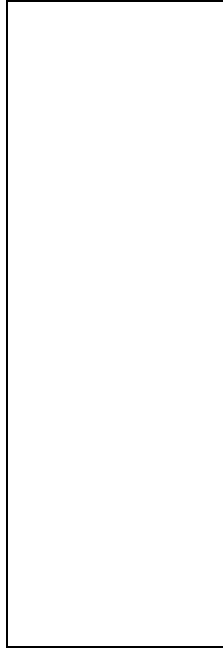

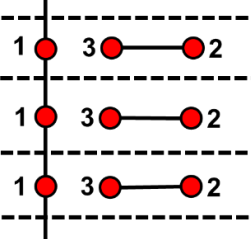
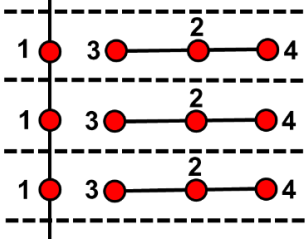
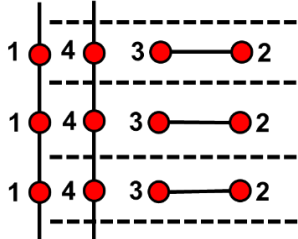
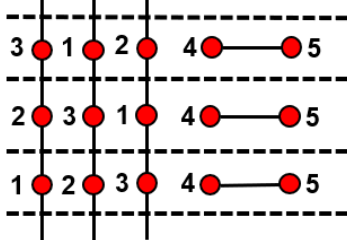
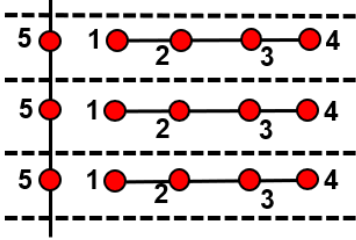
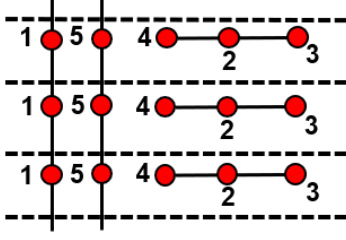

	<p>(2x2<sup>1</sup>, 4x2<sup>2</sup>)</p>	<p>(6x2<sup>2</sup>)</p>	
<sup>4</sup> V <sub>4</sub>	NG		
<sup>4</sup> V <sub>5</sub>	NG		
<sup>4</sup> V <sub>6</sub>	NG		
<sup>4</sup> V <sub>7</sub>	NG		
<sup>4</sup> V <sub>8</sub>	NG		
<b>Rank 2</b>			

${}^1V_2^2V_1$	<p>(2x1, 1x2)</p> 			
${}^1V_2^2V_2$	<p>(4x1, 1x2)</p> 	<p>(2x1, 2x2)</p> 		
${}^1V_2^2V_3$	<p>(8x1) b</p> 	<p>(6x1, 1x2)</p> 	<p>(4x1, 2x2)</p> 	

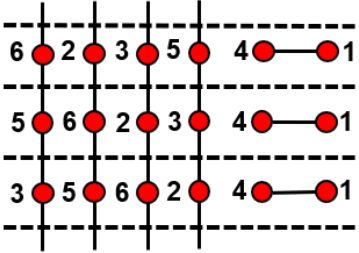
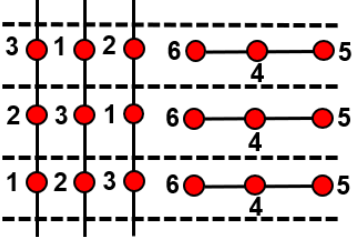
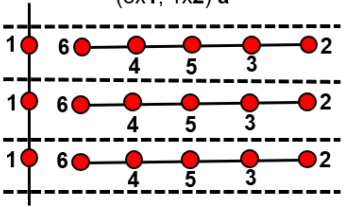
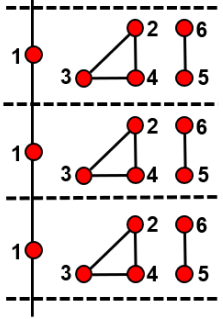
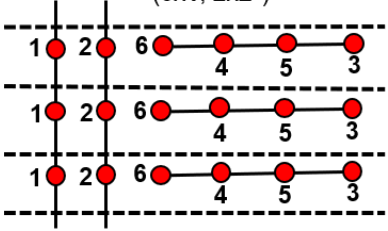
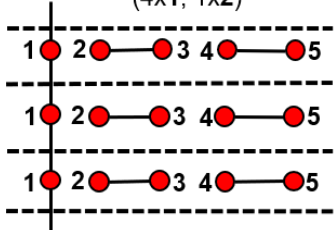
${}^1V_2^2V_4$	<p>(10x1) b</p> 	<p>(10x1) c</p> 	<p>(8x1, 1x2) a</p> 	<p>(8x1, 1x2) b</p> 
	<p>(6x1, 2x2<sup>1</sup>)</p> 			
${}^1V_2^2V_5$	NG			
${}^1V_2^2V_6$	NG			
${}^1V_4^2V_1$	<p>(4x1, 1x2)</p> 			

${}^1V_4^2V_2$	<p>(6x1, 1x2)</p>	<p>(4x1, 2x2)</p>		
${}^1V_4^2V_3$	<p>(10x1) a</p>	<p>(8x1, 1x2) a</p>	<p>(8x1, 1x2) b</p>	<p>(6x1, 2x2)</p>
${}^1V_4^2V_4$	<p>(12x1) d</p>	<p>(12x1) e</p>	<p>(10x1, 1x2) a</p>	<p>(10x1, 1x2) b</p>

	<p>(10x1, 1x2) c</p>	<p>(8x1, 2x2) a</p>	<p>(8x1, 2x2) b</p>	
${}^1V_6^2V_1$	<p>(6x1, 1x2)</p>			

${}^1V_6^2V_2$	<p style="text-align: center;">(8x1, 1x2)</p>	<p style="text-align: center;">(6x1, 2x2)</p>		
${}^1V_r^3V_r$				
${}^1V_1^3V_1$	<p style="text-align: center;">(2x1, 1x2)</p>			

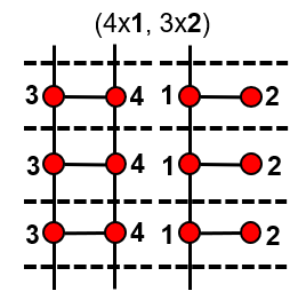
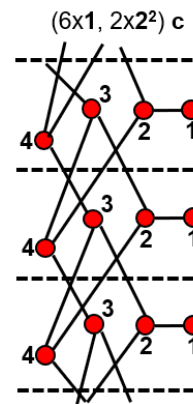
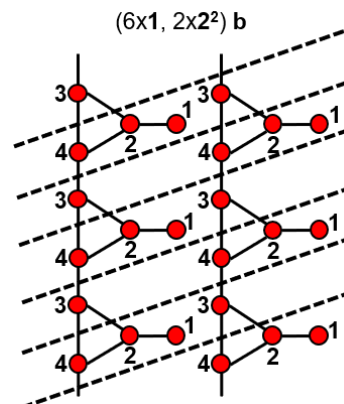
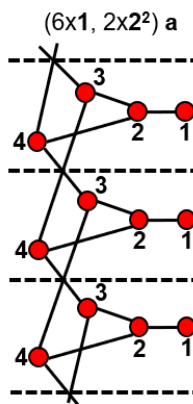
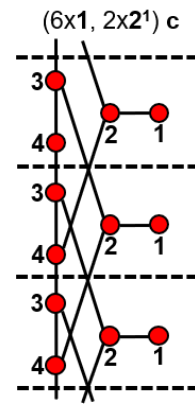
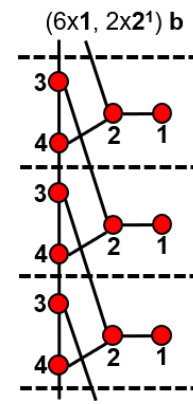
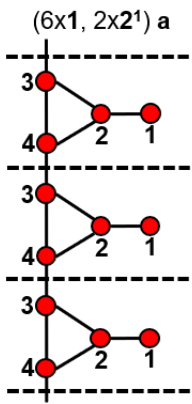
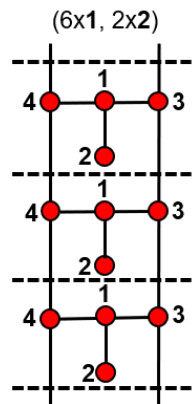
${}^1V_1{}^3V_3$ 

	<p>(4x1, 1x2, 2x2<sup>1</sup>)</p>	<p>(4x1, 1x2, 2x2<sup>2</sup>)</p>		
${}^1V_1{}^3V_5$	NG			
${}^1V_1{}^3V_7$	NG			
${}^1V_2{}^3V_2$	<p>(6x1, 1x2)</p>	<p>(4x1, 2x2) a</p>	<p>(4x1, 2x2) b</p>	
${}^1V_2{}^3V_4$	NG			
${}^1V_2{}^3V_6$	NG			

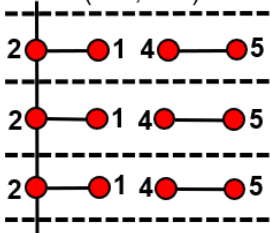
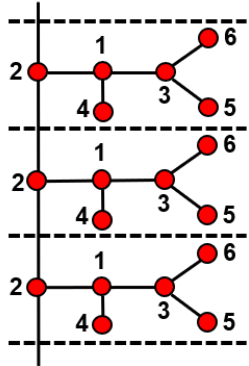
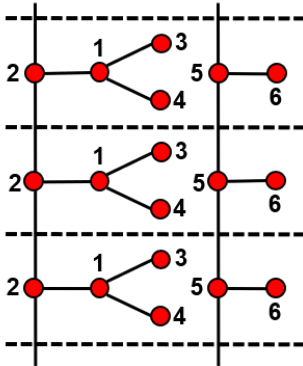
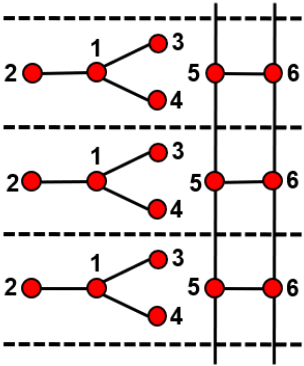
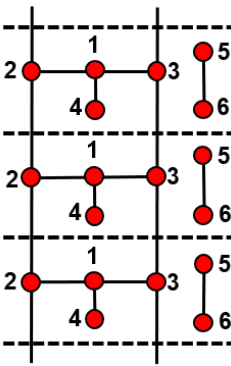
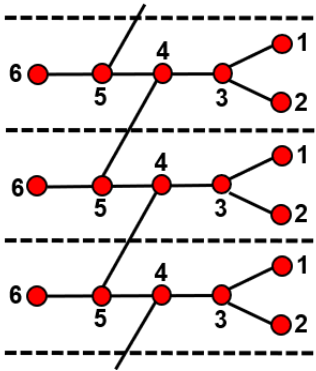
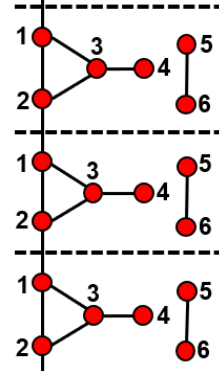
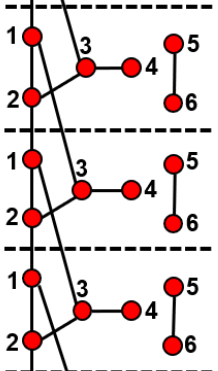
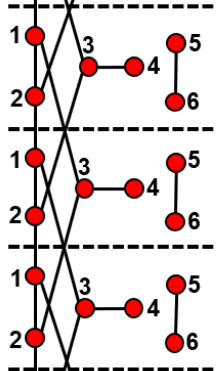

${}^1V_3^3V_1$	<p>(4x1, 1x2)</p> 			
${}^1V_3^3V_3$	<p>(10x1, 1x2)</p> 	<p>(8x1, 2x2) a</p> 	<p>(8x1, 2x2) b</p> 	<p>(8x1, 2x2) c</p> 
	<p>(8x1, 2x2<sup>1</sup>) a</p> 	<p>(8x1, 2x2<sup>1</sup>) b-1</p> 	<p>(8x1, 2x2<sup>1</sup>) b-2</p> 	<p>(8x1, 2x2<sup>1</sup>) b-3</p> 

	<p>(8x1, 2x2<sup>2</sup>) a</p>	<p>(8x1, 2x2<sup>2</sup>) b-1</p>	<p>(8x1, 2x2<sup>2</sup>) b-2</p>	<p>(8x1, 2x2<sup>2</sup>) b-3</p>
	<p>(6x1, 3x2) a</p>	<p>(6x1, 3x2) b</p>		
${}^1V_3{}^3V_5$	NG			
${}^1V_4{}^3V_2$	<p>(8x1, 1x2) a</p>	<p>(8x1, 1x2) b</p>	<p>(6x1, 2x2) a</p>	<p>(6x1, 2x2) b</p>

${}^1V_4{}^3V_4$	NG		
${}^1V_5{}^3V_1$	<p>(6x1, 1x2)</p>		
${}^1V_5{}^3V_3$	NG		
${}^1V_6{}^3V_2$	NG		
${}^1V_7{}^3V_1$	NG		
${}^1V_r{}^4V_r$			
${}^1V_2{}^4V_1$	<p>(4x1, 1x2)</p>		
${}^1V_2{}^4V_2$	<p>(6x1, 2x2)</p>	<p>(4x1, 1x2, 2x2')</p>	<p>(4x1, 1x2, 2x2')</p>
			<p>(2x1, 2x2, 2x2')</p>

	<p>(2x1, 2x2, 2x2<sup>2</sup>)</p>			
${}^1V_2{}^4V_3$	<p>(10x1, 2x2) 1</p>	<p>(10x1, 2x2) 2</p>	<p>(10x1, 2x2) 3</p>	<p>(10x1, 2x2) 4</p>
	<p>(8x1, 3x2) a-1</p>	<p>(8x1, 3x2) a-2</p>	<p>(8x1, 3x2) a-3</p>	<p>(8x1, 3x2) a-4</p>

	<p>(8x1, 3x2) b</p>	<p>(8x1, 1x2, 2x2<sup>1</sup>) 1</p>	<p>(8x1, 1x2, 2x2<sup>1</sup>) 2</p>	<p>(8x1, 1x2, 2x2<sup>1</sup>) 3</p>
	<p>(8x1, 1x2, 2x2<sup>2</sup>) 1</p>	<p>(8x1, 1x2, 2x2<sup>2</sup>) 2</p>	<p>(8x1, 1x2, 2x2<sup>2</sup>) 3</p>	<p>(6x1, 2x2, 2x2<sup>1</sup>)</p>

	<p>(6x1, 2x2, 2x2<sup>2</sup>)</p>	<p>(6x1, 4x2<sup>1</sup>) 1</p>	<p>(6x1, 4x2<sup>1</sup>) 2</p>	<p>(6x1, 4x2<sup>1</sup>) 3</p>
	<p>(6x1, 2x2<sup>1</sup>, 2x2<sup>2</sup>) 1</p>	<p>(6x1, 2x2<sup>1</sup>, 2x2<sup>2</sup>) 2</p>	<p>(6x1, 4x2<sup>2</sup>) 1</p>	<p>(6x1, 4x2<sup>2</sup>) 2</p>
	<p>(4x1, 3x2, 2x2<sup>1</sup>)</p>	<p>(4x1, 3x2, 2x2<sup>2</sup>)</p>	<p>(4x1, 1x2, 4x2<sup>1</sup>)</p>	<p>(4x1, 1x2, 2x2<sup>1</sup>, 2x2<sup>2</sup>)</p>

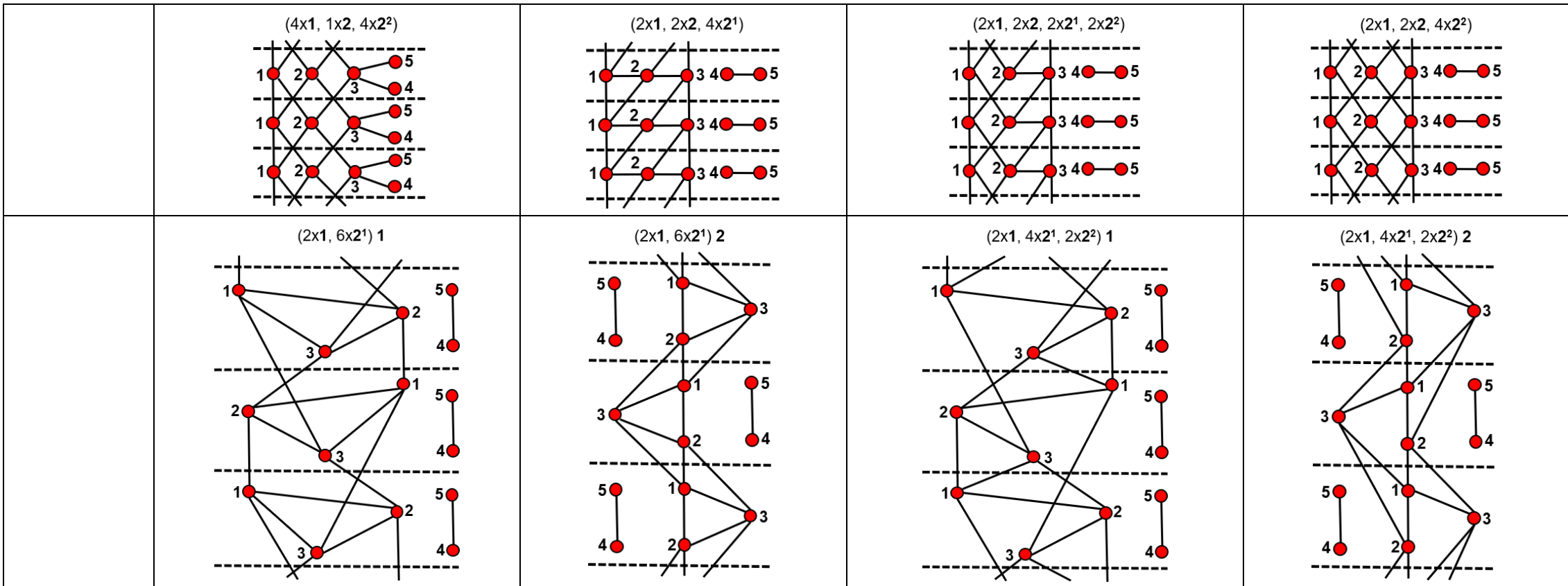

	<p>(2x1, 2x2<sup>1</sup>, 4x2<sup>2</sup>)</p>	<p>(2x1, 6x2<sup>2</sup>)</p>		
${}^1V_2{}^4V_4$	NG			
${}^1V_2{}^4V_5$	NG			
${}^1V_2{}^4V_6$	NG			
${}^1V_4{}^4V_1$	<p>(6x1, 1x2)</p>			

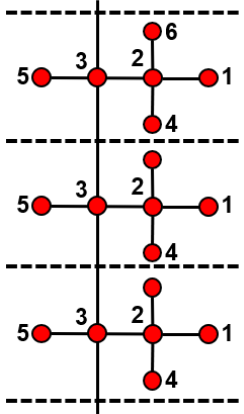
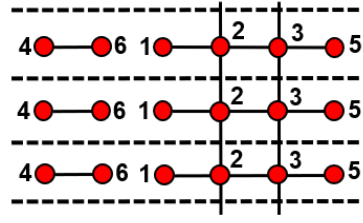
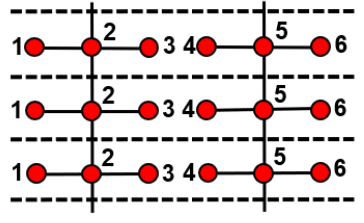
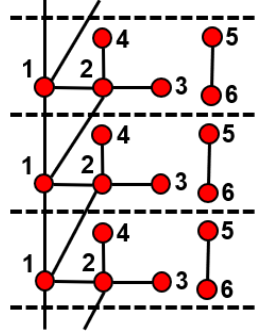
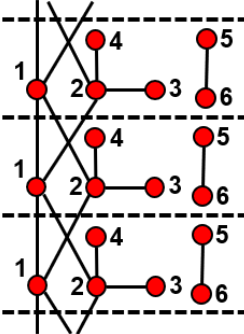
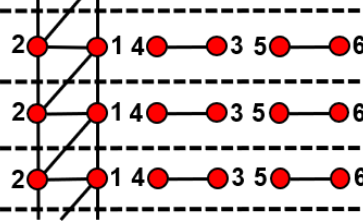
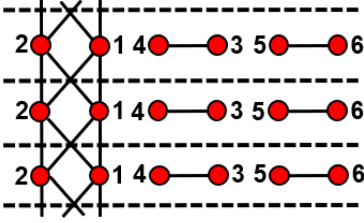

${}^1V_4{}^4V_2$	<p>(10x1, 1x2)</p> 	<p>(8x1, 2x2) a</p> 	<p>(8x1, 2x2) b</p> 	<p>(6x1, 1x2, 2x2<sup>1</sup>)</p> 
	<p>(6x1, 1x2, 2x2<sup>2</sup>)</p> 	<p>(4x1, 2x2, 2x2<sup>1</sup>)</p> 	<p>(4x1, 2x2, 2x2<sup>2</sup>)</p> 	
${}^1V_4{}^4V_3$	NG			
${}^1V_4{}^4V_4$	NG			

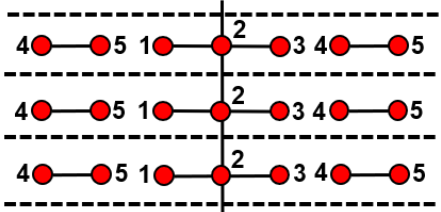
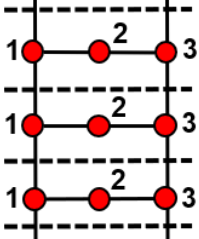
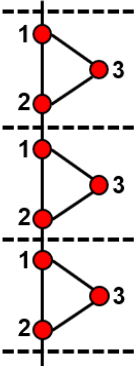
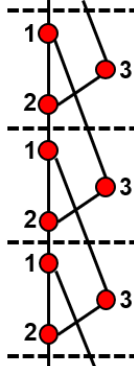
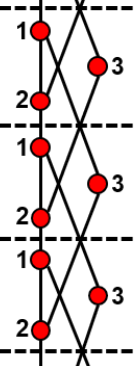
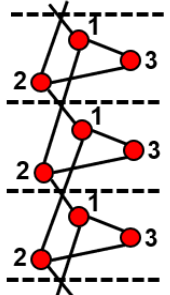
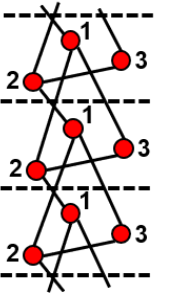
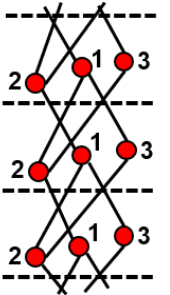
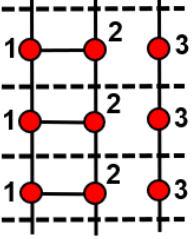
${}^1V_6{}^4V_1$	<p>(8x1, 1x2)</p> 			
${}^1V_6{}^4V_2$	NG			
${}^2V_r{}^3V_r$				
${}^2V_1{}^3V_2$	<p>(4x1, 2x2)</p> 	<p>(4x1, 2x2<sup>1</sup>) a</p> 	<p>(4x1, 2x2<sup>1</sup>) b</p> 	<p>(4x1, 2x2<sup>1</sup>) c</p> 
	<p>(4x1, 2x2<sup>2</sup>) a</p> 	<p>(4x1, 2x2<sup>2</sup>) b</p> 	<p>(4x1, 2x2<sup>2</sup>) c</p> 	<p>(2x1, 3x2)</p> 

	<p>(2x1, 1x2, 2x2<sup>1</sup>)</p>	<p>(2x1, 1x2, 2x2<sup>2</sup>)</p>		
${}^2V_1{}^3V_4$	NG			
${}^2V_1{}^3V_6$	NG			
${}^2V_2{}^3V_2$	<p>(10x1) a</p>	<p>(10x1) b</p>	<p>(10x1) c</p>	<p>(10x1) d</p>

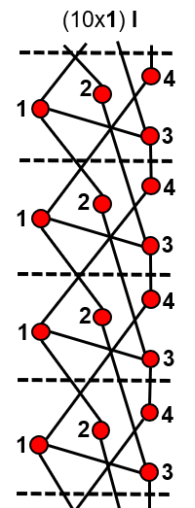
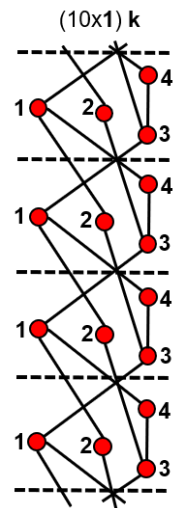
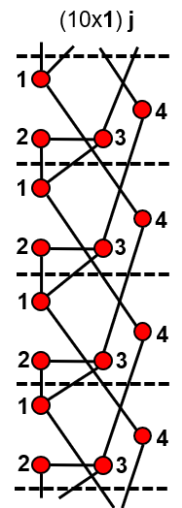
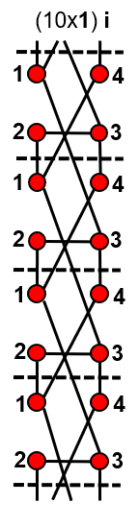
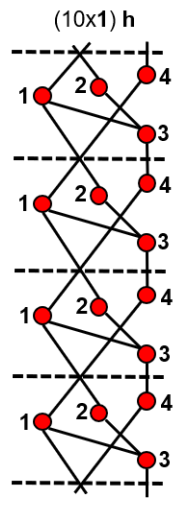
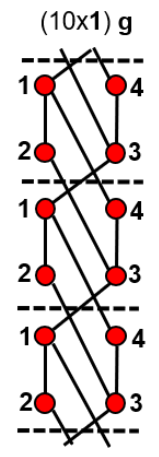
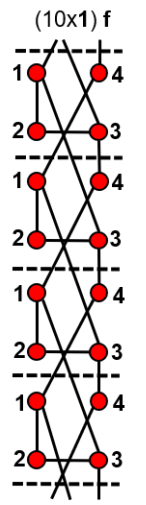
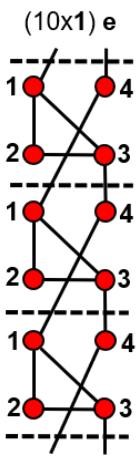

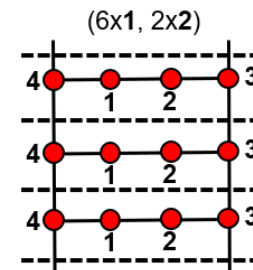
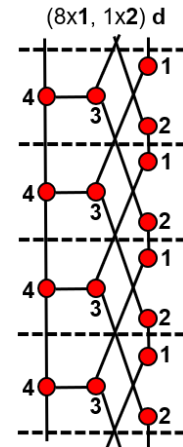
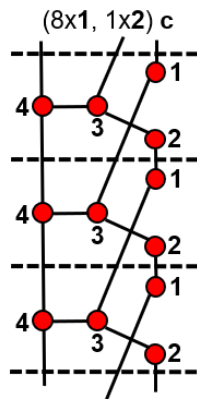
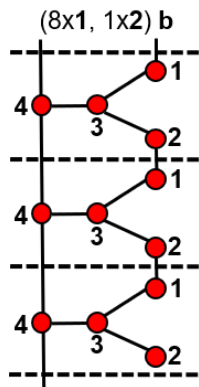
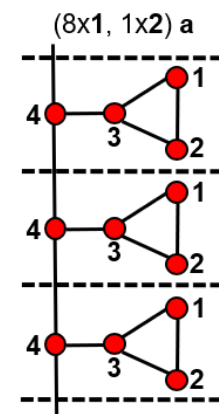
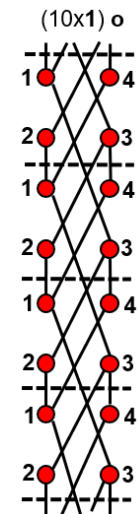
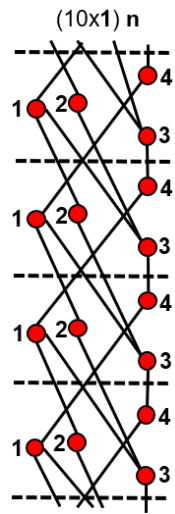
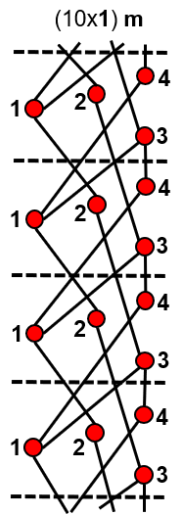

(6x1, 2x2<sup>1</sup>) a

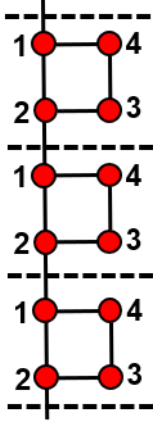

(6x1, 2x2<sup>1</sup>) b

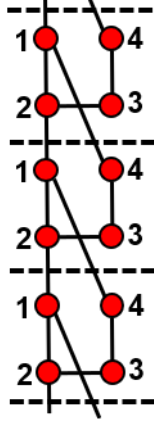

(6x1, 2x2<sup>1</sup>) c

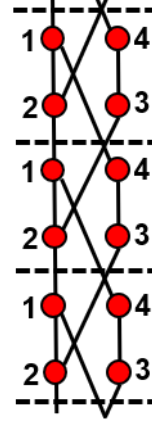

(6x1, 2x2<sup>1</sup>) d

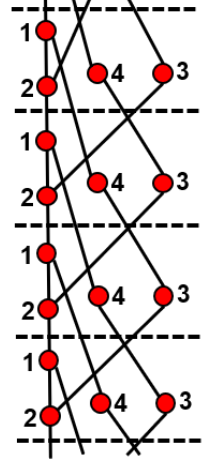

(6x1, 2x2<sup>2</sup>) a

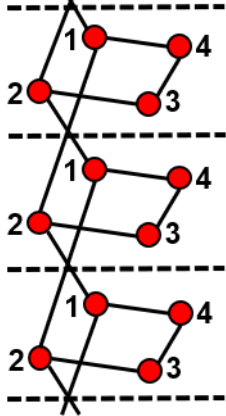

(6x1, 2x2<sup>2</sup>) b

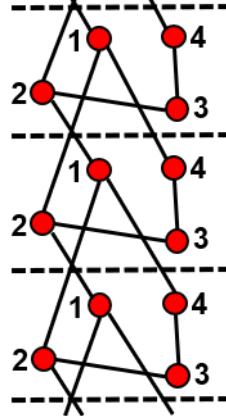

(6x1, 2x2<sup>2</sup>) c

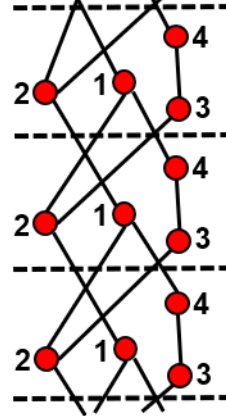

(6x1, 2x2<sup>2</sup>) d

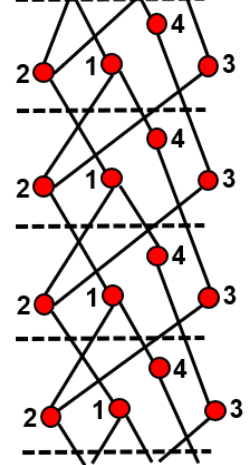

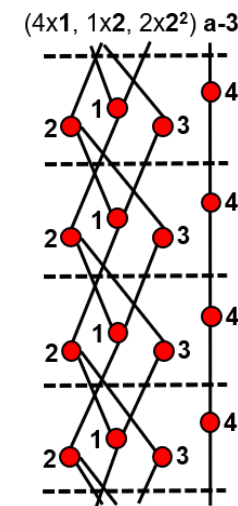
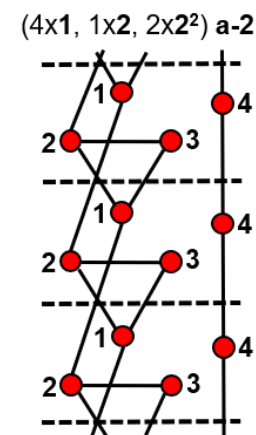
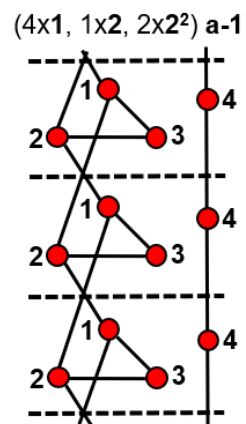
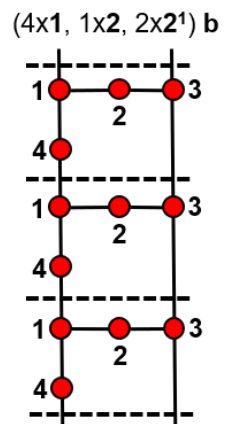
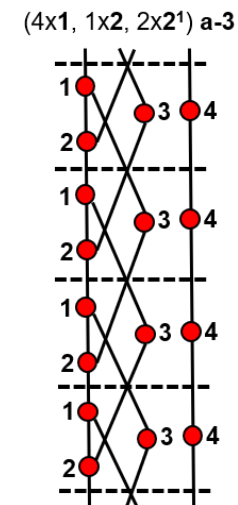
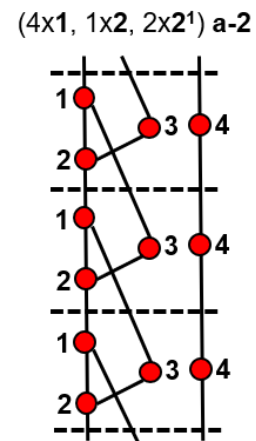
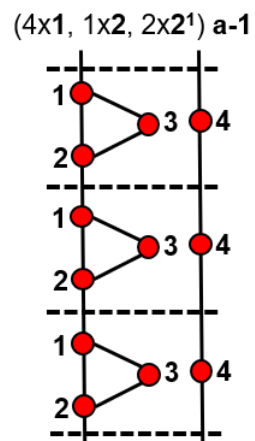
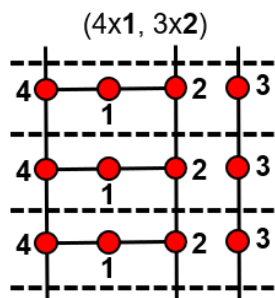

	<p>(4x1, 1x2, 2x2<sup>2</sup>) b</p>	<p>(2x1, 4x2)</p>	<p>(2x1, 2x2, 2x2<sup>1</sup>) b</p>	<p>(2x1, 2x2, 2x2<sup>2</sup>) b</p>
	<p>(2x1, 4x2<sup>1</sup>)</p>	<p>(2x1, 2x2<sup>1</sup>, 2x2<sup>2</sup>)</p>	<p>(2x1, 4x2<sup>2</sup>)</p>	
${}^2V_2{}^3V_4$	NG			
${}^2V_2{}^3V_6$	NG			
${}^2V_3{}^3V_2$	NG			
${}^2V_3{}^3V_4$	NG			
${}^2V_4{}^3V_2$	NG			



${}^2V_4{}^3V_4$	NG			
${}^2V_5{}^3V_2$	NG			
${}^2V_6{}^3V_2$	NG			
${}^2V_r{}^4V_r$				
${}^2V_1{}^4V_1$	<p>(1x2, 2x2<sup>1</sup>)</p>	<p>(1x2, 2x2<sup>2</sup>)</p>		
${}^2V_1{}^4V_2$	<p>(6x1, 2x2) a</p>	<p>(6x1, 2x2) b</p>	<p>(6x1, 2x2) c</p>	<p>(6x1, 2x2) d</p>

	<p>(3x2, 2x2<sup>1</sup>)</p>	<p>(3x2, 2x2<sup>2</sup>)</p>	<p>(1x2, 4x2<sup>1</sup>)</p>	<p>(1x2, 2x2<sup>1</sup>, 2x2<sup>2</sup>) a</p>
	<p>(1x2, 2x2<sup>1</sup>, 2x2<sup>2</sup>) b</p>	<p>(1x2, 4x2<sup>2</sup>)</p>		
${}^2V_1{}^4V_3$	<p>(8x1, 3x2) a</p>	<p>(8x1, 3x2) b</p>	<p>(8x1, 3x2) c</p>	<p>(8x1, 3x2) d</p>

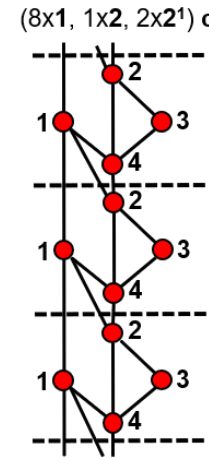
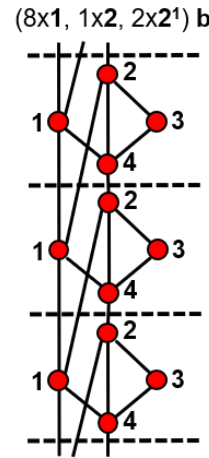
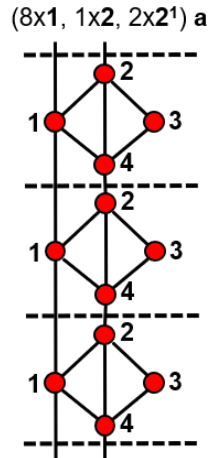
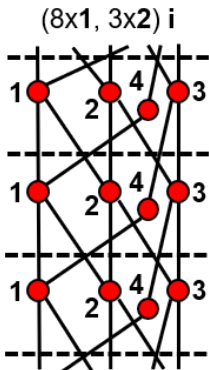
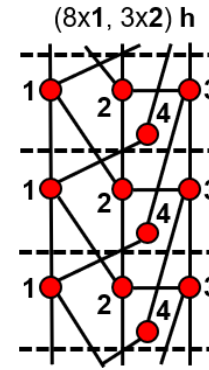
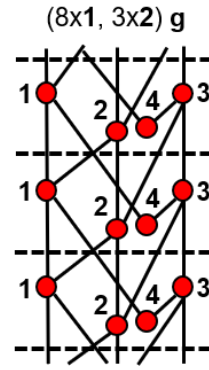
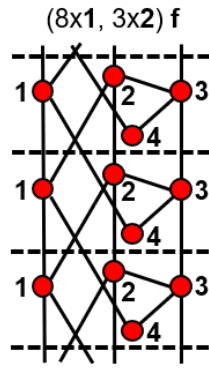
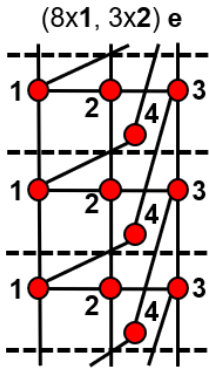

(8x1, 1x2, 2x2<sup>1</sup>) d

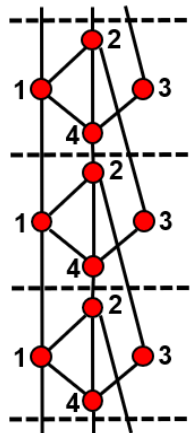

(8x1, 1x2, 2x2<sup>1</sup>) e

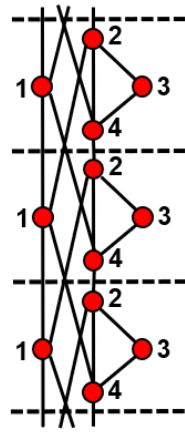

(8x1, 1x2, 2x2<sup>1</sup>) f

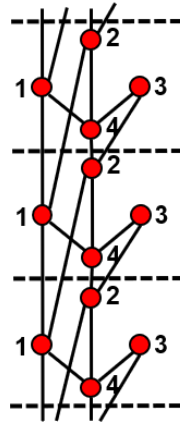

(8x1, 1x2, 2x2<sup>1</sup>) g

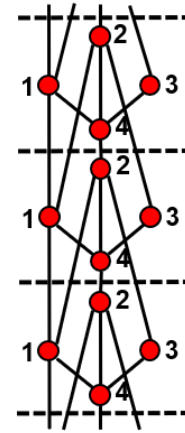

(8x1, 1x2, 2x2<sup>1</sup>) h

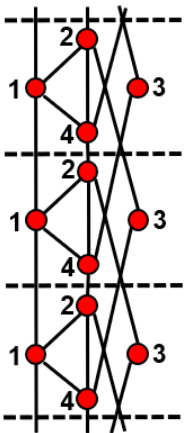

(8x1, 1x2, 2x2<sup>1</sup>) i

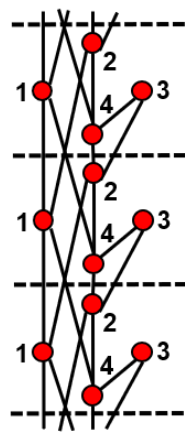

(8x1, 1x2, 2x2<sup>1</sup>) j

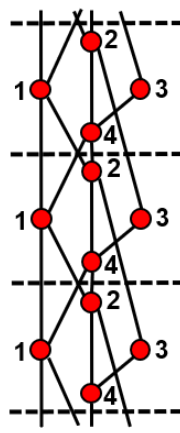

(8x1, 1x2, 2x2<sup>1</sup>) k

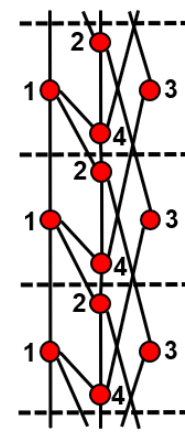

(8x1, 1x2, 2x2<sup>1</sup>) l

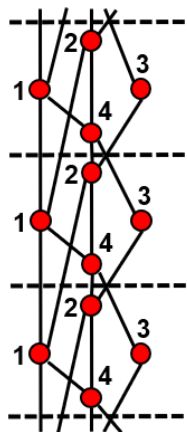

(8x1, 1x2, 2x2<sup>2</sup>) a

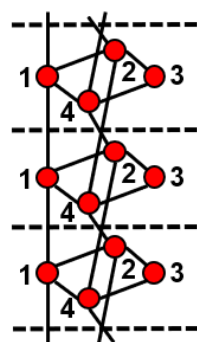

(8x1, 1x2, 2x2<sup>2</sup>) b

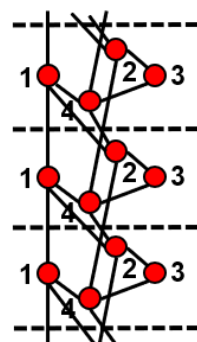

(8x1, 1x2, 2x2<sup>2</sup>) c

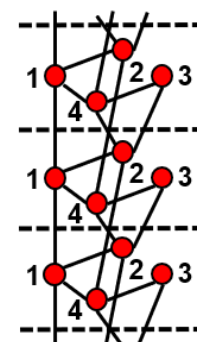

(8x1, 1x2, 2x2<sup>2</sup>) d

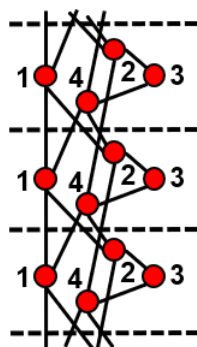

(8x1, 1x2, 2x2<sup>2</sup>) e

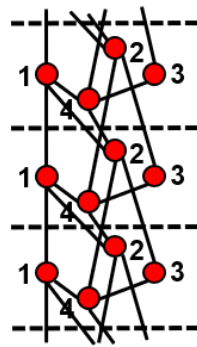

(8x1, 1x2, 2x2<sup>2</sup>) f

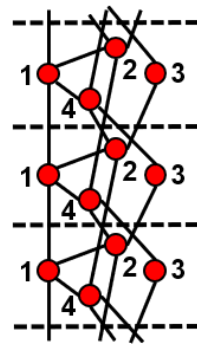

(8x1, 1x2, 2x2<sup>2</sup>) g

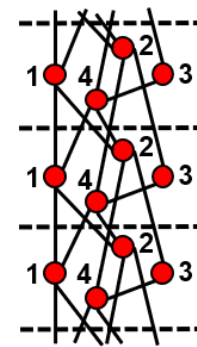

(8x1, 1x2, 2x2<sup>2</sup>) h

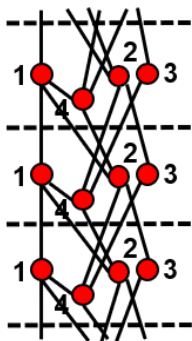

(8x1, 1x2, 2x2<sup>2</sup>) i

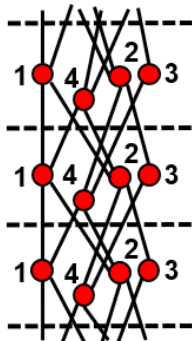

(6x1, 4x2) a

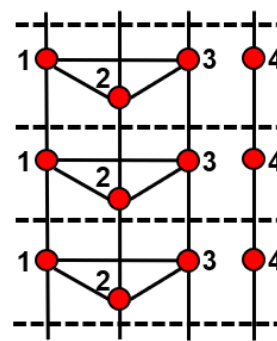

(6x1, 4x2) b

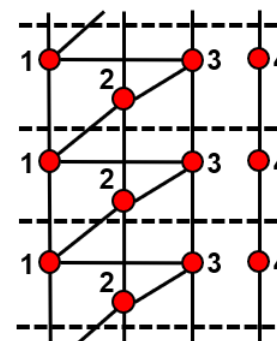

(6x1, 4x2) c

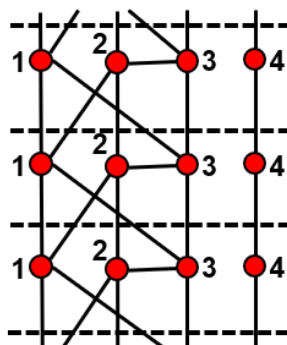

(6x1, 4x2) d

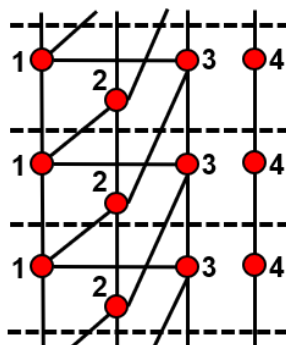

(6x1, 4x2) e

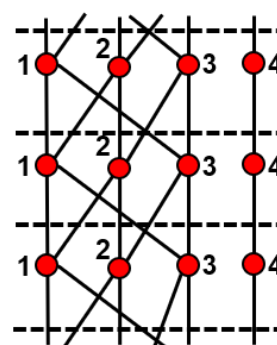

(6x1, 2x2, 2x2<sup>1</sup>) a-1

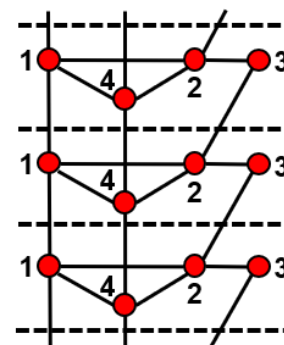

	<p>(6x1, 2x2, 2x2<sup>1</sup>) a-2</p>	<p>(6x1, 2x2, 2x2<sup>1</sup>) a-3</p>	<p>(6x1, 2x2, 2x2<sup>1</sup>) a-4</p>	<p>(6x1, 2x2, 2x2<sup>1</sup>) a-5</p>
	<p>(6x1, 2x2, 2x2<sup>1</sup>) a-6</p>	<p>(6x1, 2x2, 2x2<sup>1</sup>) a-7</p>	<p>(6x1, 2x2, 2x2<sup>1</sup>) b-1</p>	<p>(6x1, 2x2, 2x2<sup>1</sup>) b-2</p>

(6x1, 2x2, 2x2<sup>1</sup>) b-3

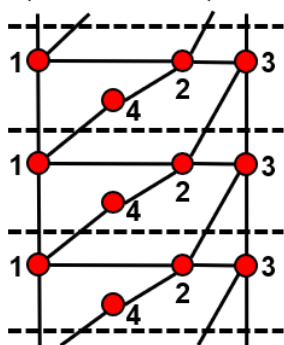

(6x1, 2x2, 2x2<sup>1</sup>) b-4

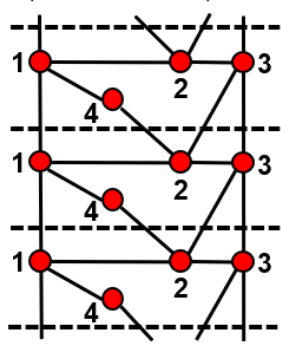

(6x1, 2x2, 2x2<sup>1</sup>) b-5

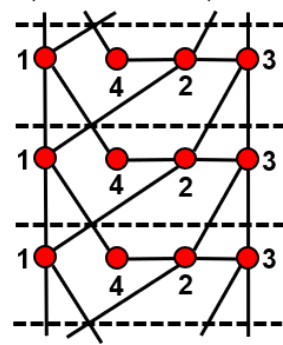

(6x1, 2x2, 2x2<sup>1</sup>) b-6

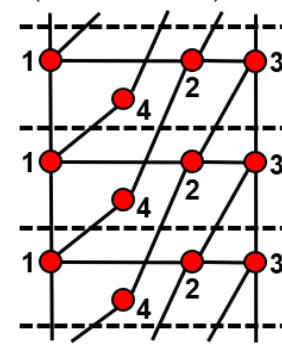

(6x1, 2x2, 2x2<sup>1</sup>) b-7

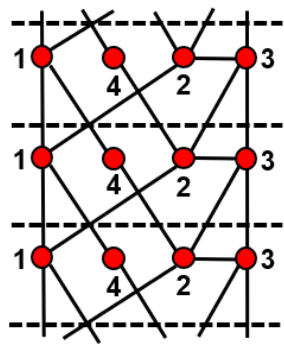

(6x1, 2x2, 2x2<sup>2</sup>) a-1

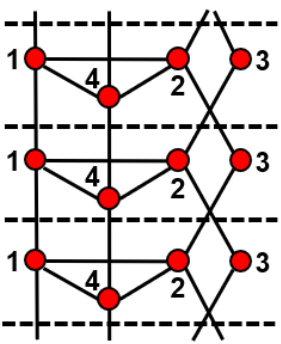

(6x1, 2x2, 2x2<sup>2</sup>) a-2

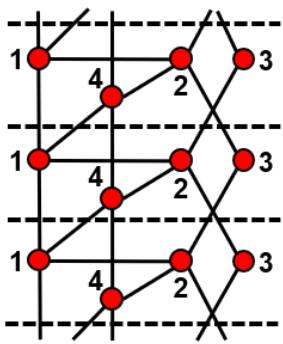

(6x1, 2x2, 2x2<sup>2</sup>) a-3

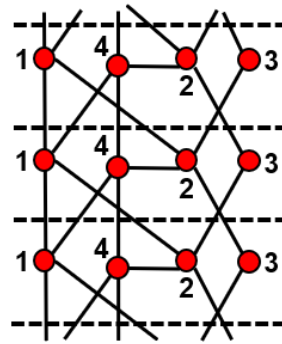



(6x1, 2x2, 2x2<sup>2</sup>) a-4

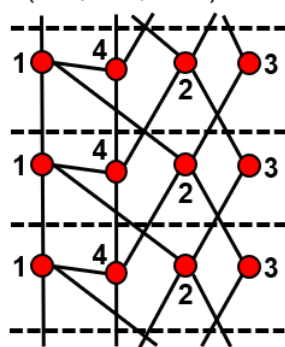

(6x1, 2x2, 2x2<sup>2</sup>) a-5

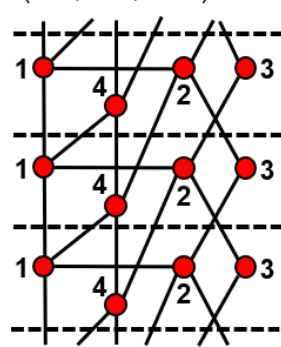

(6x1, 2x2, 2x2<sup>2</sup>) a-6

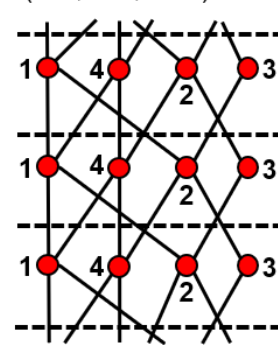

(6x1, 2x2, 2x2<sup>2</sup>) b-1

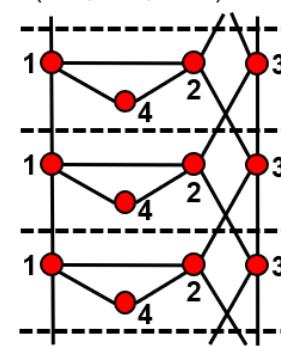

(6x1, 2x2, 2x2<sup>2</sup>) b-2

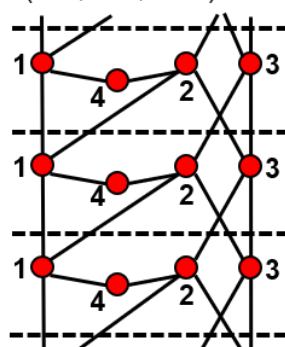

(6x1, 2x2, 2x2<sup>2</sup>) b-3

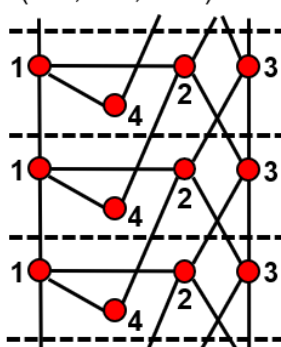

(6x1, 2x2, 2x2<sup>2</sup>) b-4

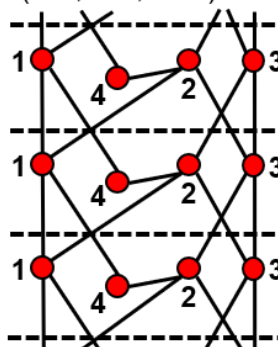

(6x1, 2x2, 2x2<sup>2</sup>) b-5

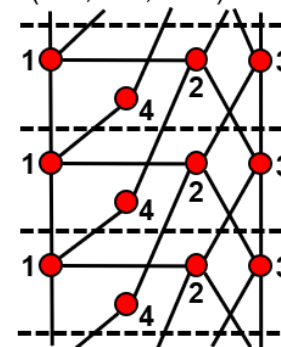

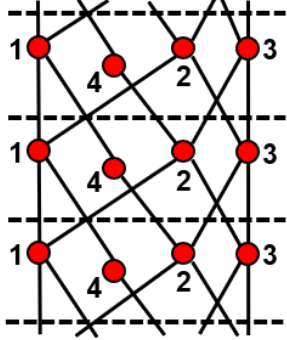
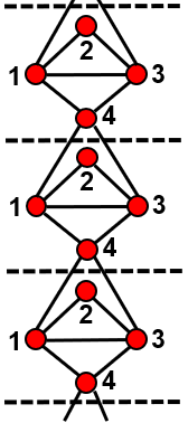
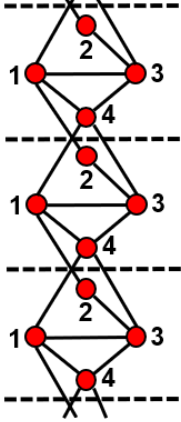
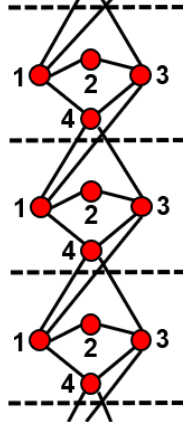
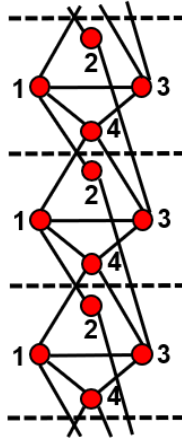
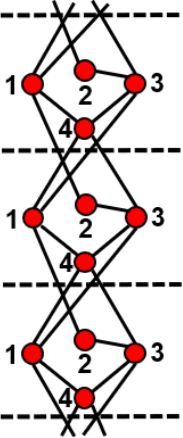
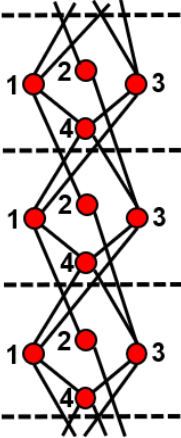
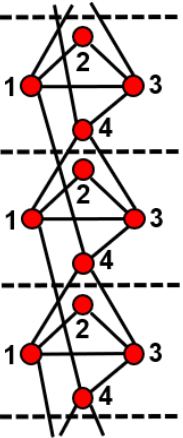
	<p>(6x1, 2x2, 2x2<sup>2</sup>) b-6</p> 	<p>(6x1, 4x2<sup>1</sup>) a</p> 	<p>(6x1, 4x2<sup>1</sup>) b</p> 	<p>(6x1, 4x2<sup>1</sup>) c</p> 
	<p>(6x1, 4x2<sup>1</sup>) d</p> 	<p>(6x1, 4x2<sup>1</sup>) e</p> 	<p>(6x1, 4x2<sup>1</sup>) f</p> 	<p>(6x1, 2x2<sup>1</sup>, 2x2<sup>2</sup>) a</p> 

(6x1, 2x2<sup>1</sup>, 2x2<sup>2</sup>) b

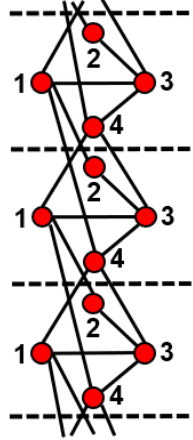

(6x1, 2x2<sup>1</sup>, 2x2<sup>2</sup>) c

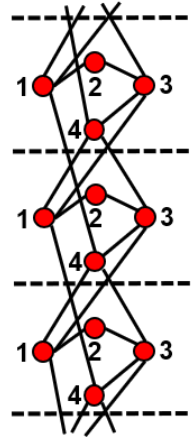

(6x1, 2x2<sup>1</sup>, 2x2<sup>2</sup>) d

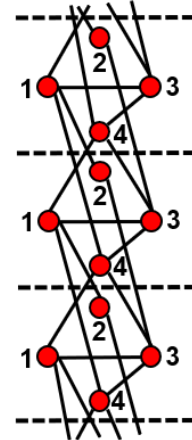

(6x1, 2x2<sup>1</sup>, 2x2<sup>2</sup>) e

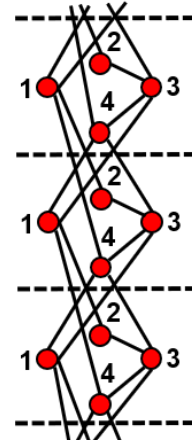

(6x1, 2x2<sup>1</sup>, 2x2<sup>2</sup>) f

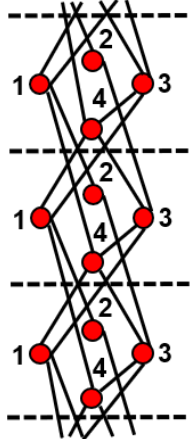

(6x1, 4x2<sup>2</sup>) a

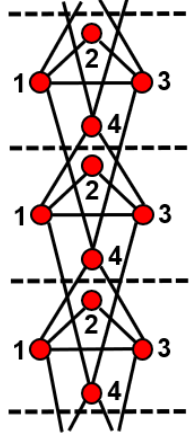

(6x1, 4x2<sup>2</sup>) b

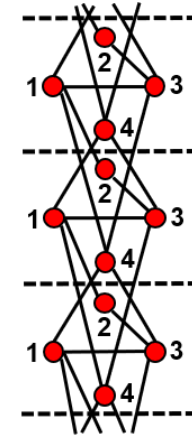

(6x1, 4x2<sup>2</sup>) c

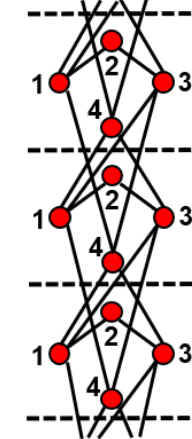

(6x1, 4x2<sup>2</sup>) d

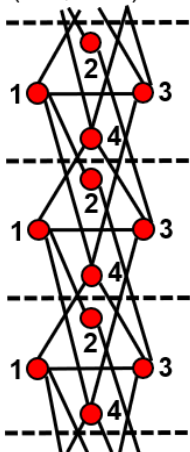

(6x1, 4x2<sup>2</sup>) e

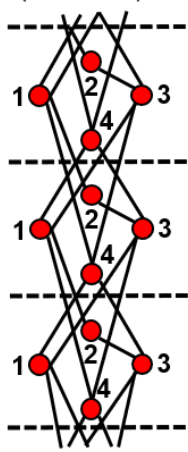

(6x1, 4x2<sup>2</sup>) f

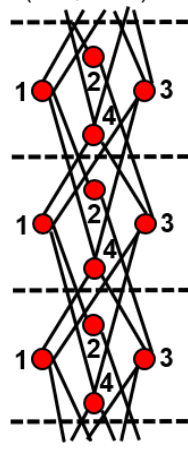

(3x2, 4x2<sup>1</sup>) a-1

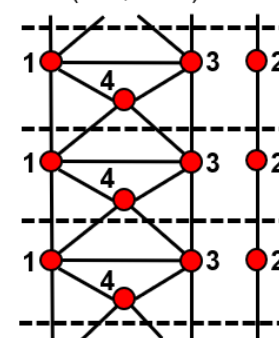

(3x2, 4x2<sup>1</sup>) a-2

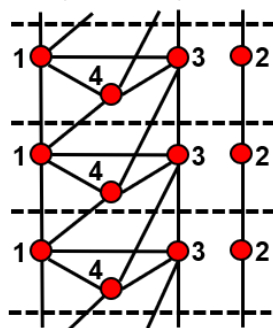

(3x2, 4x2<sup>1</sup>) b

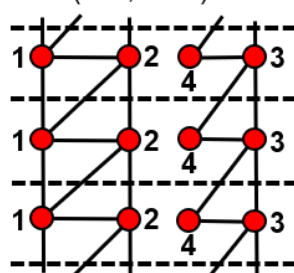

(3x2, 2x2<sup>1</sup>, 2x2<sup>2</sup>) a-1

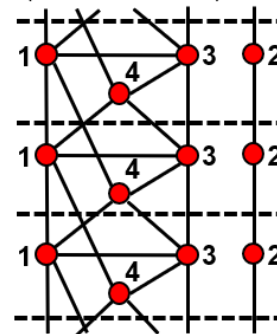

(3x2, 2x2<sup>1</sup>, 2x2<sup>2</sup>) a-2

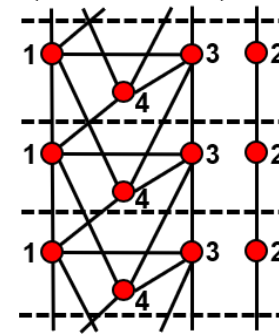

	<p>(3x2, 2x2<sup>1</sup>, 2x2<sup>2</sup>) b</p>	<p>(3x2, 2x2<sup>1</sup>, 2x2<sup>2</sup>) c</p>	<p>(3x2, 4x2<sup>2</sup>) a</p>	<p>(3x2, 4x2<sup>2</sup>) b</p>
	<p>(1x2, 6x2<sup>1</sup>) a-1</p>	<p>(1x2, 6x2<sup>1</sup>) a-2</p>	<p>(1x2, 6x2<sup>1</sup>) b</p>	<p>(1x2, 4x2<sup>1</sup>, 2x2<sup>2</sup>) a-1</p>
	<p>(1x2, 4x2<sup>1</sup>, 2x2<sup>2</sup>) a-2</p>	<p>(1x2, 4x2<sup>1</sup>, 2x2<sup>2</sup>) b</p>	<p>(1x2, 4x2<sup>1</sup>, 2x2<sup>2</sup>) c</p>	<p>(1x2, 2x2<sup>1</sup>, 4x2<sup>2</sup>) a</p>

	<p>(1x2, 2x2<sup>1</sup>, 4x2<sup>2</sup>) b</p>	<p>(1x2, 2x2<sup>1</sup>, 4x2<sup>2</sup>) c</p>	<p>(1x2, 2x2<sup>1</sup>, 4x2<sup>2</sup>) d</p>	<p>(1x2, 6x2<sup>2</sup>) a</p>
	<p>(1x2, 6x2<sup>2</sup>) b</p>			
${}^2V_1{}^4V_4$	NG			
${}^2V_1{}^4V_5$	NG			
${}^2V_1{}^4V_6$	NG			
${}^2V_1{}^4V_7$	NG			

${}^2V_2{}^4V_1$ 

(6x1, 1x2) a

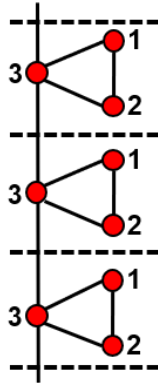

(6x1, 1x2) b

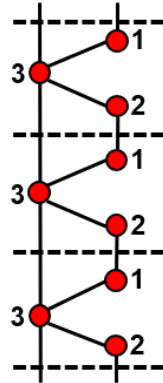

(6x1, 1x2) c

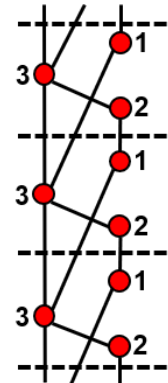

(6x1, 1x2) d

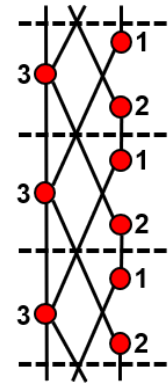
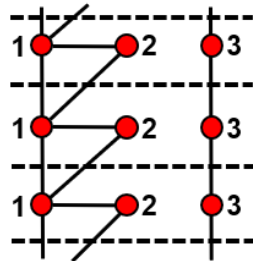
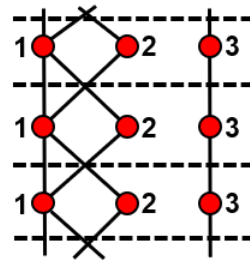
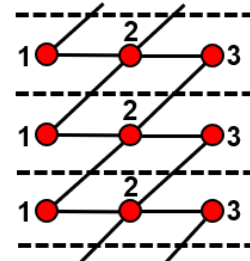
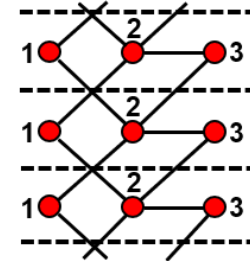
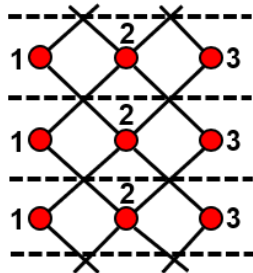
(2x2, 2x2<sup>1</sup>)(2x2, 2x2<sup>2</sup>)(4x2<sup>1</sup>)(2x2<sup>1</sup>, 2x2<sup>2</sup>)(4x2<sup>2</sup>)

${}^2V_2^4V_2$

(8x1, 2x2) a-1

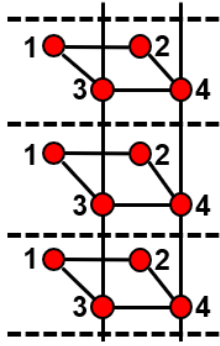

(8x1, 2x2) a-2

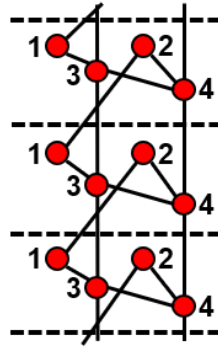

(8x1, 2x2) a-3

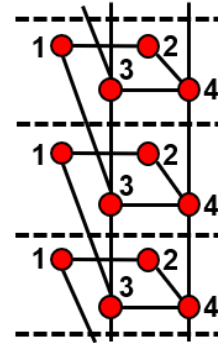

(8x1, 2x2) a-4

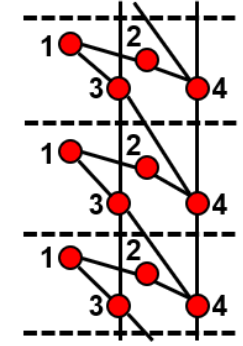

(8x1, 2x2) a-5

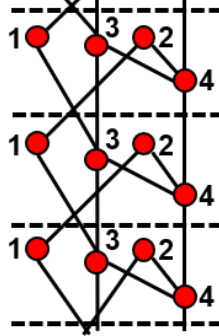

(8x1, 2x2) a-6

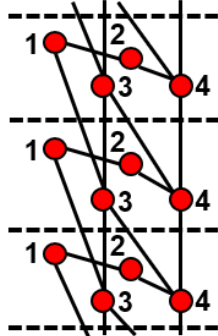

(8x1, 2x2) a-7

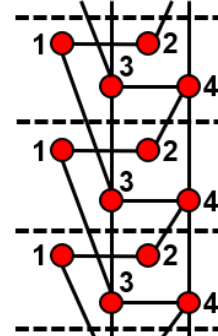

(8x1, 2x2) a-8

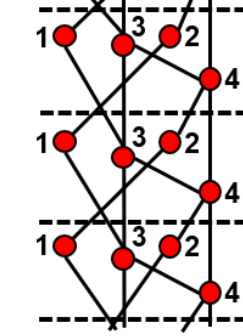



	<p>(8x1, 2x2) a-9</p>	<p>(8x1, 2x2) a-10</p>	<p>(8x1, 2x2) a-11</p>	<p>(8x1, 2x2) b-1</p>
	<p>(8x1, 2x2) b-2</p>	<p>(8x1, 2x2) b-3</p>	<p>(8x1, 2x2) b-4</p>	<p>(8x1, 2x2) b-5</p>

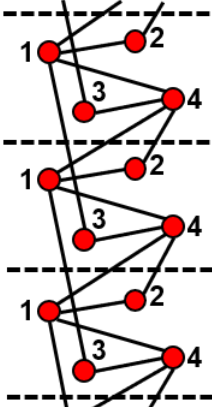
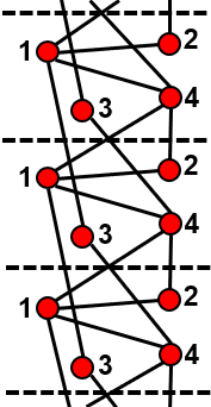
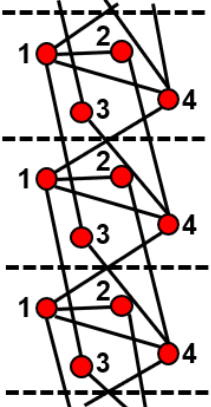
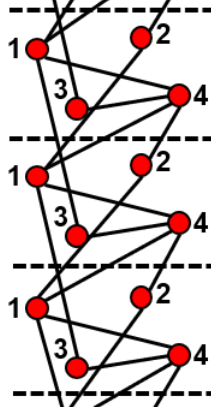
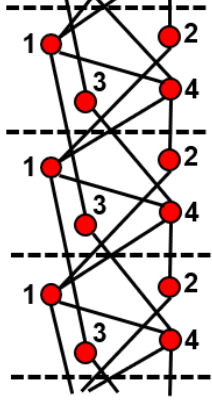
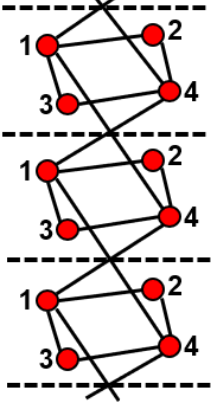
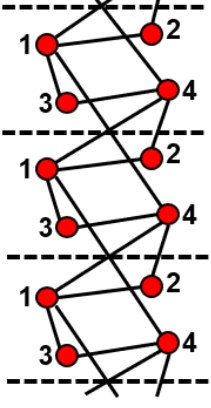
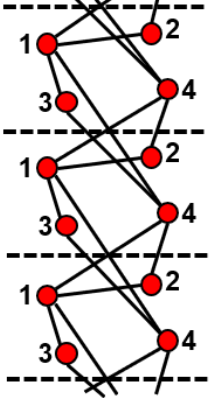

	<p>(8x1, 2x2<sup>1</sup>) g</p> 	<p>(8x1, 2x2<sup>1</sup>) h</p> 	<p>(8x1, 2x2<sup>1</sup>) i</p> 	<p>(8x1, 2x2<sup>1</sup>) j</p> 
	<p>(8x1, 2x2<sup>2</sup>) k</p> 	<p>(8x1, 2x2<sup>2</sup>) a</p> 	<p>(8x1, 2x2<sup>2</sup>) b</p> 	<p>(8x1, 2x2<sup>2</sup>) c</p> 

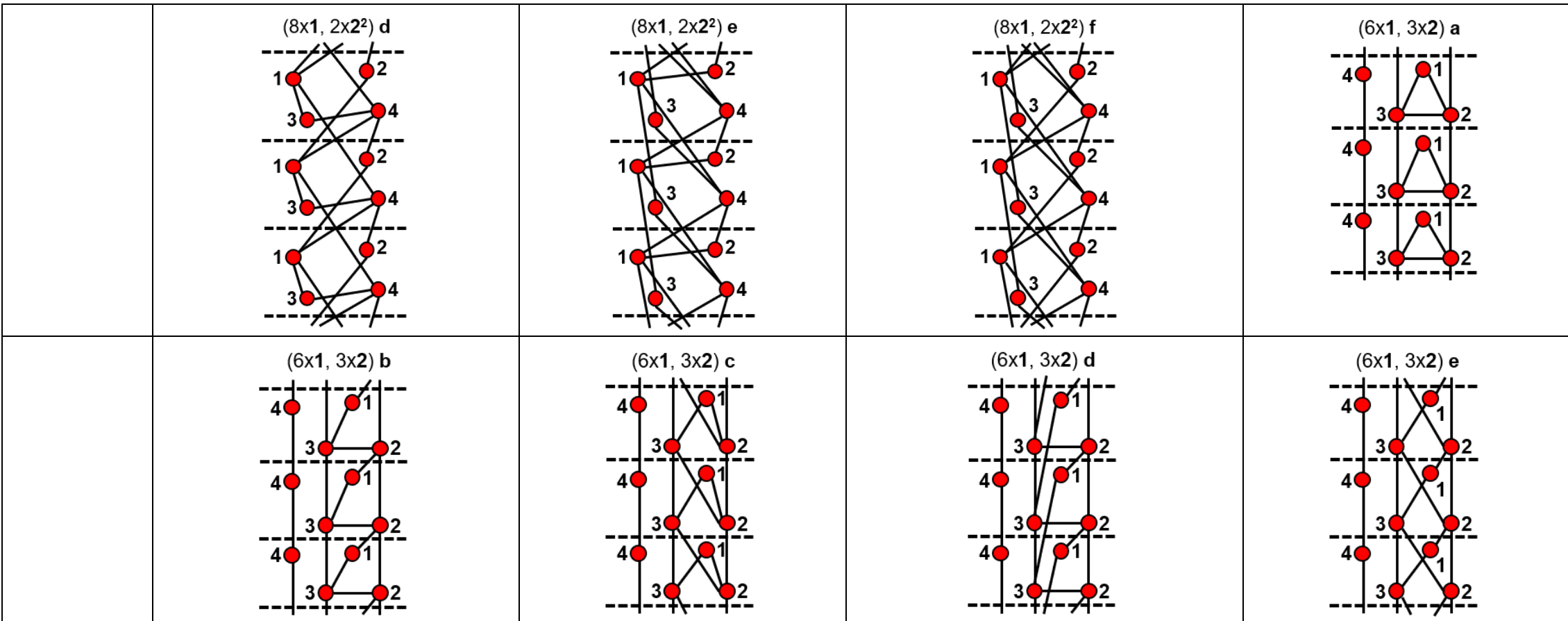

	<p>(6x1, 3x2) f</p>	<p>(6x1, 1x2, 2x2<sup>1</sup>) a-1</p>	<p>(6x1, 1x2, 2x2<sup>1</sup>) a-2</p>	<p>(6x1, 1x2, 2x2<sup>1</sup>) a-3</p>
	<p>(6x1, 1x2, 2x2<sup>1</sup>) a-4</p>	<p>(6x1, 1x2, 2x2<sup>1</sup>) a-5</p>	<p>(6x1, 1x2, 2x2<sup>1</sup>) a-6</p>	<p>(6x1, 1x2, 2x2<sup>1</sup>) a-7</p>

(6x1, 1x2, 2x2<sup>1</sup>) a-8

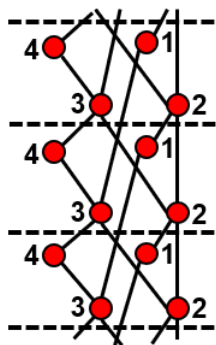

(6x1, 1x2, 2x2<sup>1</sup>) b-1

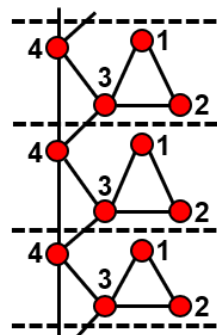

(6x1, 1x2, 2x2<sup>1</sup>) b-2

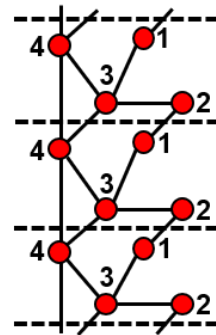

(6x1, 1x2, 2x2<sup>1</sup>) b-3

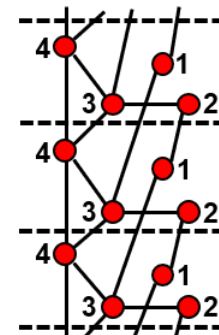

(6x1, 1x2, 2x2<sup>2</sup>) b-4

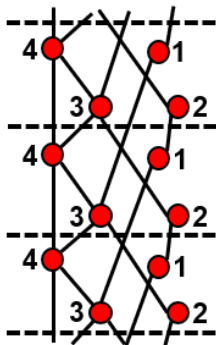

(6x1, 1x2, 2x2<sup>2</sup>) a-1

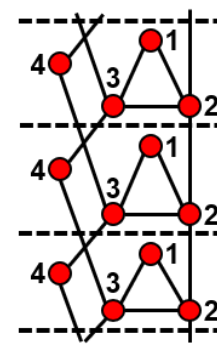

(6x1, 1x2, 2x2<sup>2</sup>) a-2

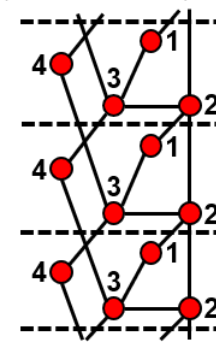

(6x1, 1x2, 2x2<sup>2</sup>) a-3

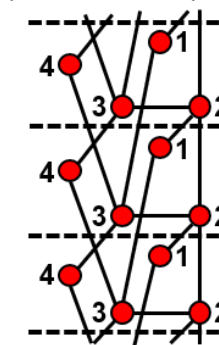

(6x1, 1x2, 2x2<sup>2</sup>) a-4

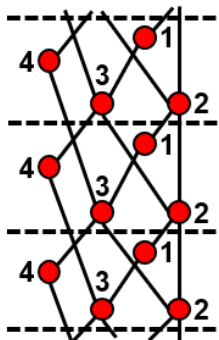

(6x1, 1x2, 2x2<sup>2</sup>) a-5

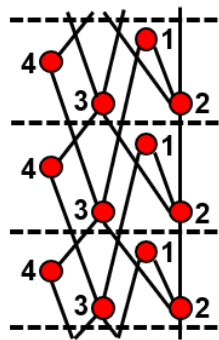

(6x1, 1x2, 2x2<sup>2</sup>) a-6

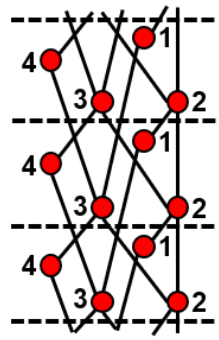

(6x1, 1x2, 2x2<sup>2</sup>) b-1

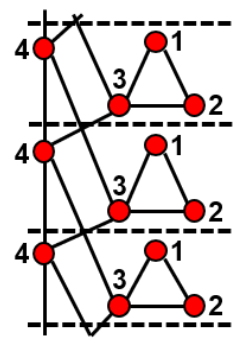

(6x1, 1x2, 2x2<sup>2</sup>) b-2

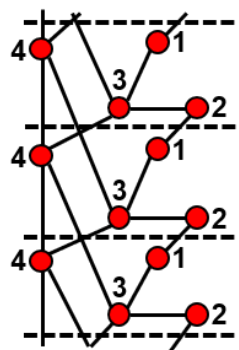

(6x1, 1x2, 2x2<sup>2</sup>) b-3

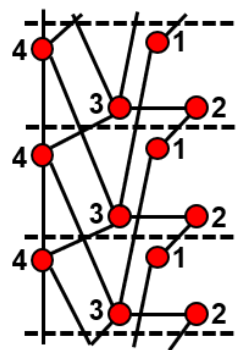

(6x1, 1x2, 2x2<sup>2</sup>) b-4

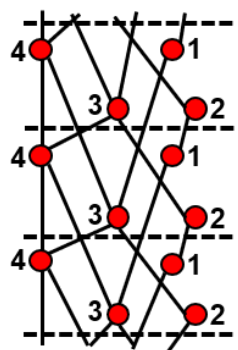

(4x2, 2x2<sup>1</sup>)

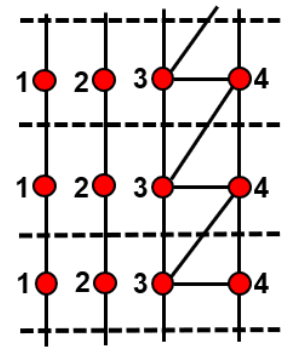

(4x2, 2x2<sup>2</sup>)

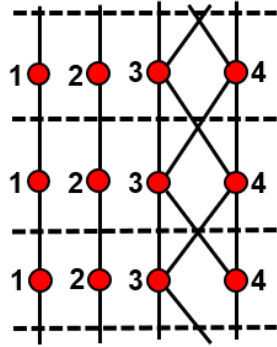

(2x2, 4x2<sup>1</sup>) b

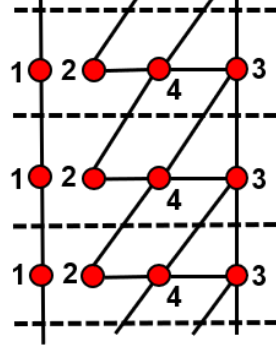

(2x2, 4x2<sup>2</sup>) c

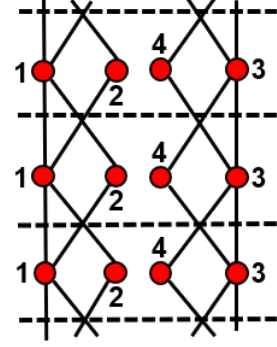

(6x2<sup>1</sup>)

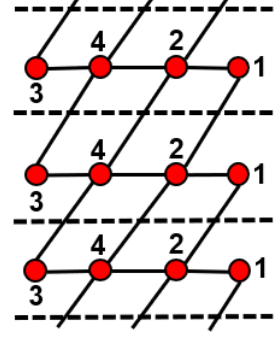

(4x2<sup>1</sup>, 2x2<sup>2</sup>) a

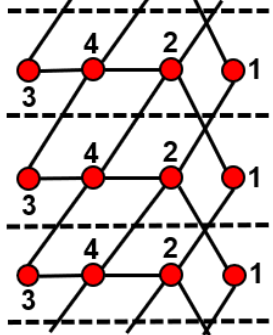

(4x2<sup>1</sup>, 2x2<sup>2</sup>) b

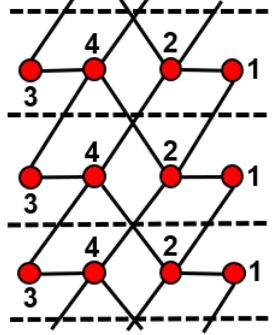

(2x2<sup>1</sup>, 4x2<sup>2</sup>) a

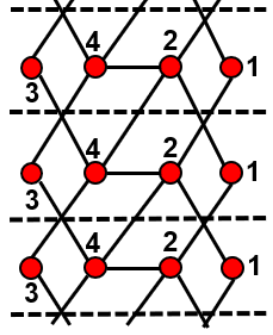

(2x2<sup>1</sup>, 4x2<sup>2</sup>) b

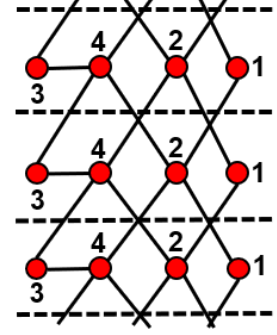



	<p>(6x2<sup>2</sup>)</p>			
${}^2V_2{}^4V_3$	NG			
${}^2V_2{}^4V_4$	NG			
${}^2V_2{}^4V_5$	NG			
${}^2V_2{}^4V_6$	NG			
${}^2V_3{}^4V_1$	<p>(8x1, 1x2) a</p>	<p>(8x1, 1x2) b</p>	<p>(8x1, 1x2) c</p>	<p>(8x1, 1x2) d</p>

(8x1, 1x2) e

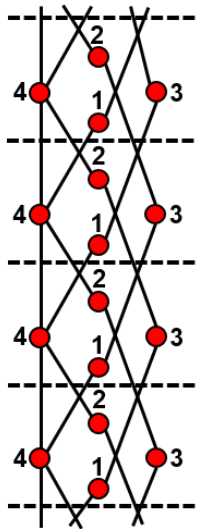

(6x1, 2x2) a

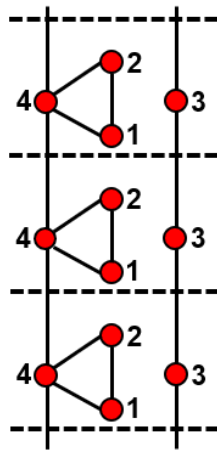

(6x1, 2x2) b

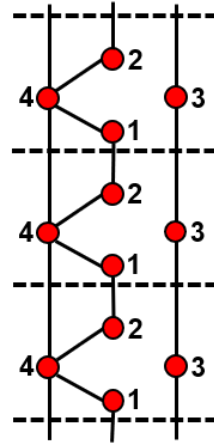

(6x1, 2x2) c

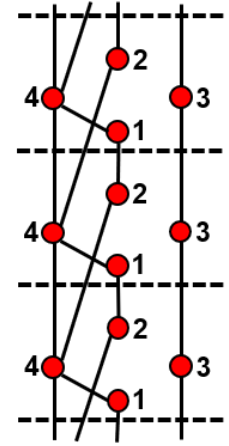

(6x1, 2x2) d

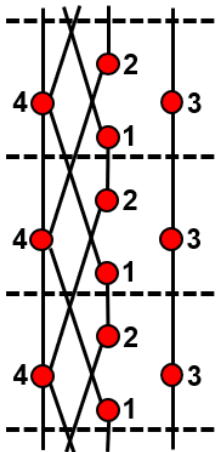

(6x1, 2x2<sup>1</sup>) a

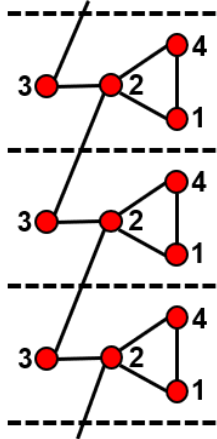

(6x1, 2x2<sup>1</sup>) b

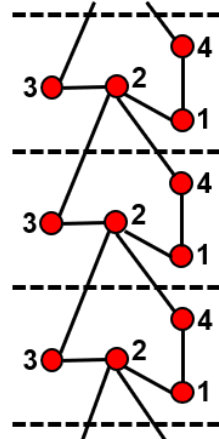

(6x1, 2x2<sup>1</sup>) c

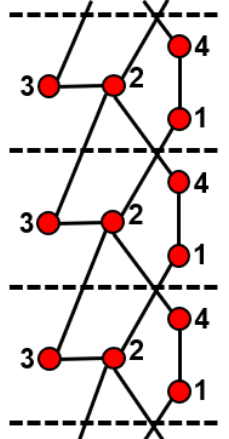

	<p>(6x1, 2x2<sup>1</sup>) d</p>	<p>(6x1, 2x2<sup>2</sup>) a</p>	<p>(6x1, 2x2<sup>2</sup>) b</p>	<p>(6x1, 2x2<sup>2</sup>) c</p>
	<p>(6x1, 2x2<sup>2</sup>) d</p>	<p>(3x2, 2x2<sup>1</sup>)</p>	<p>(3x2, 2x2<sup>2</sup>)</p>	<p>(1x2, 4x2<sup>1</sup>) b</p>

	<p>(1x2, 2x2<sup>1</sup>, 2x2<sup>2</sup>) c</p>	<p>(1x2, 4x2<sup>2</sup>) b</p>		
${}^2V_3{}^4V_2$	NG			
${}^2V_3{}^4V_3$	NG			
${}^2V_3{}^4V_4$	NG			
${}^2V_3{}^4V_5$	NG			
${}^2V_4{}^4V_1$	<p>(12x1) a</p>	<p>(12x1) b</p>	<p>(12x1) c</p>	<p>(12x1) d</p>

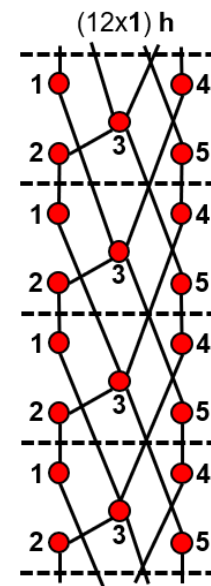
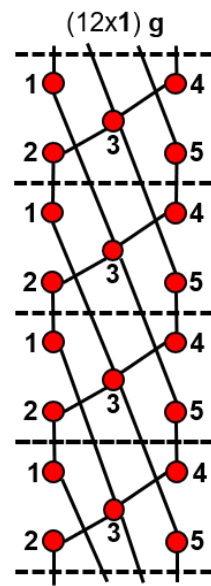
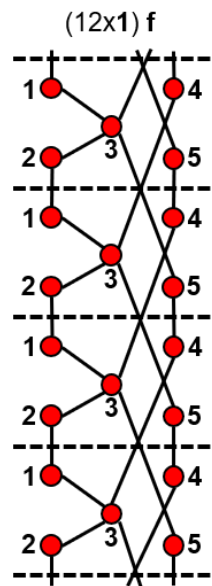
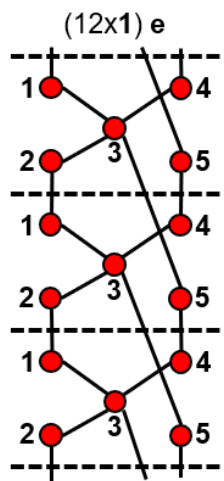

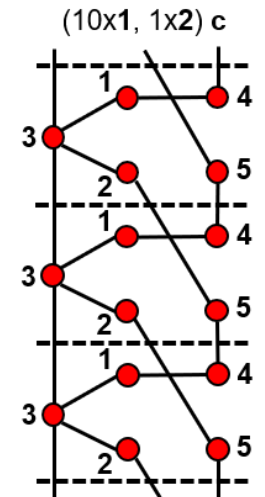
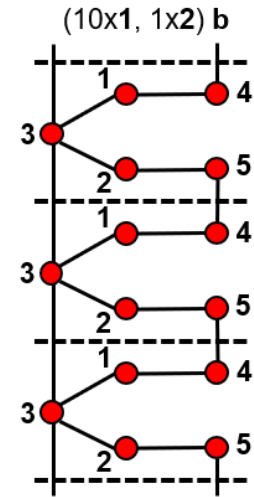
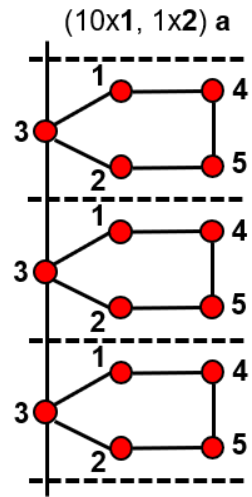
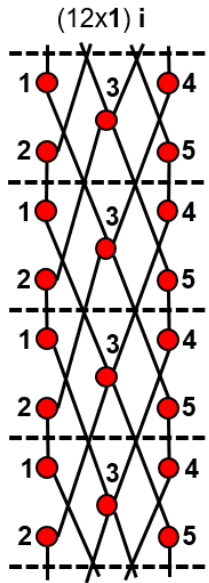

(10x1, 1x2) d

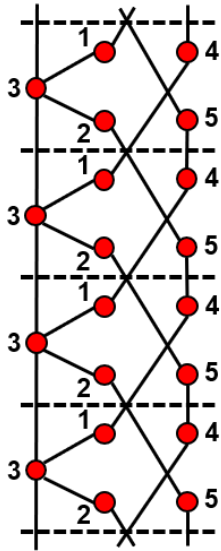

(10x1, 1x2) e

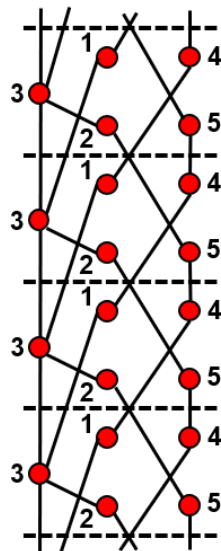

(10x1, 1x2) f

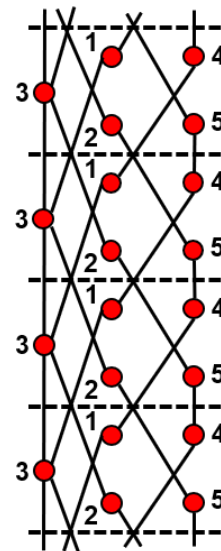

(8x1, 2x2) a

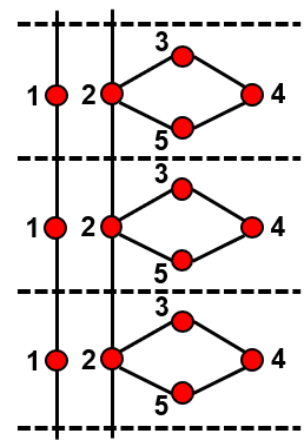

(8x1, 2x2) b

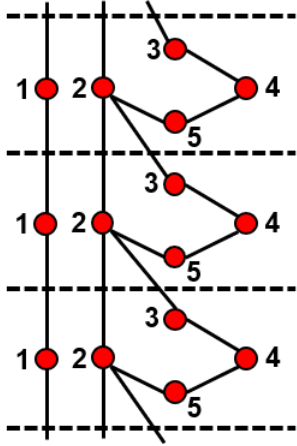

(8x1, 2x2) c

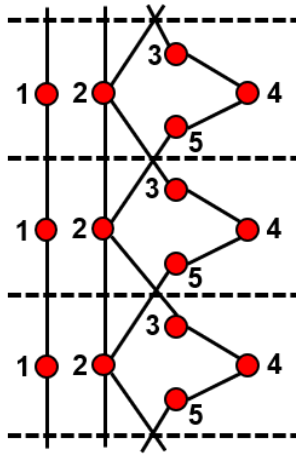

(8x1, 2x2) d

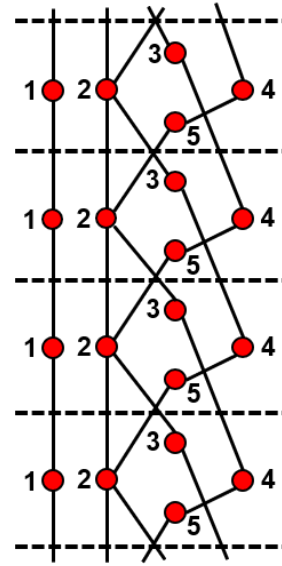

(8x1, 2x2) e

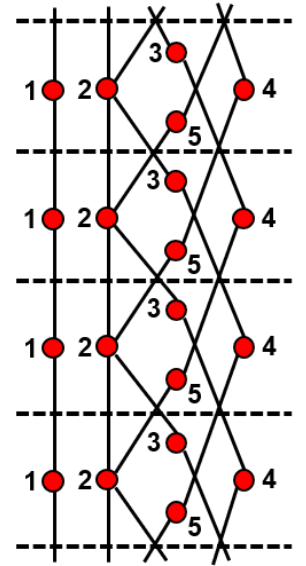



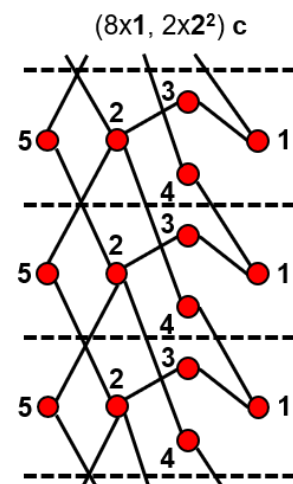
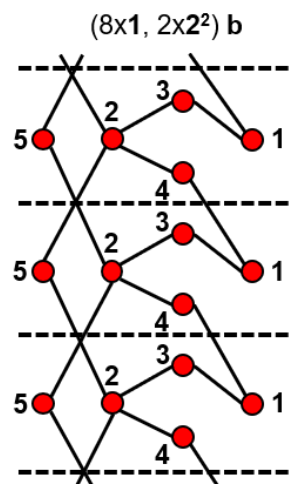
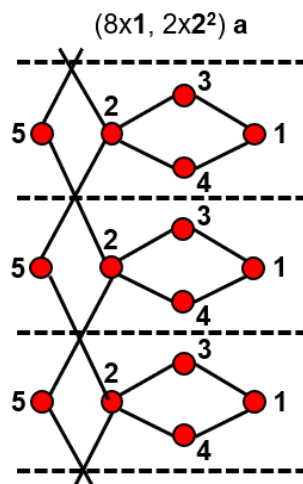
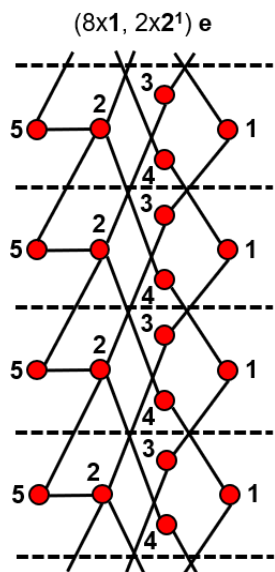
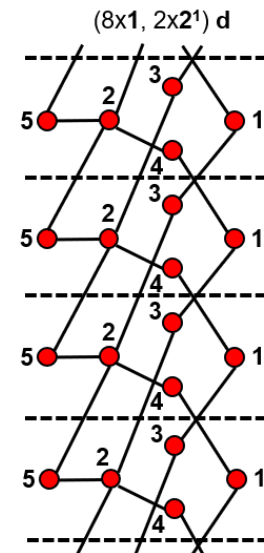
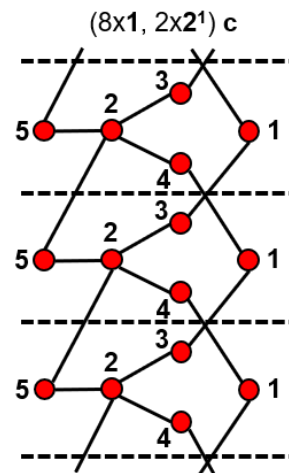
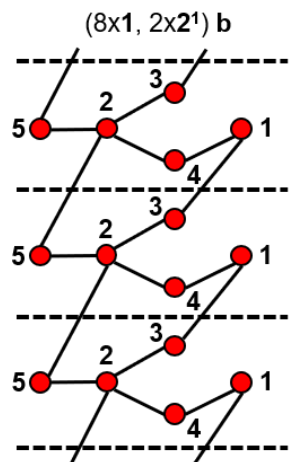
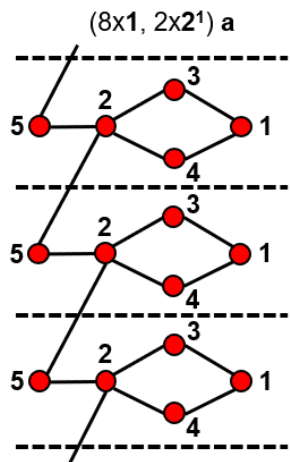

(8x1, 2x2<sup>2</sup>) d

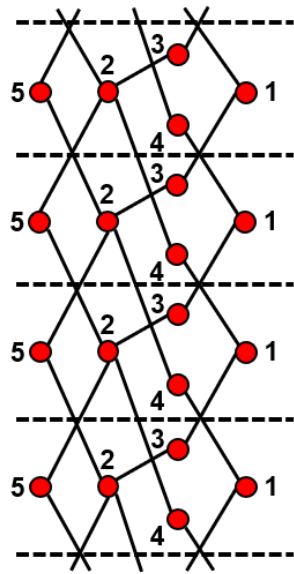

(8x1, 2x2<sup>2</sup>) e

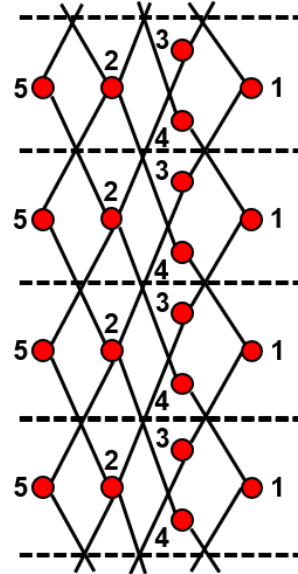

(6x1, 3x2) a

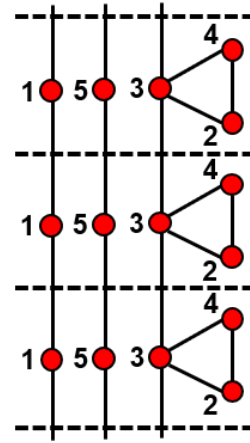

(6x1, 3x2) b

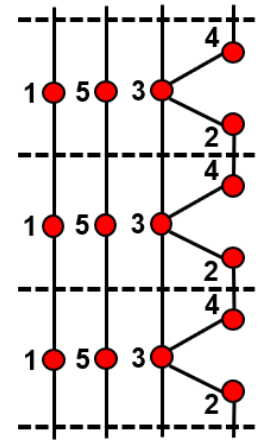

	<p>(6x1, 3x2) c</p>	<p>(6x1, 3x2) d</p>	<p>(6x1, 1x2, 2x2<sup>1</sup>) b-1</p>	<p>(6x1, 1x2, 2x2<sup>2</sup>) b-1</p>
	<p>(6x1, 1x2, 2x2<sup>1</sup>) c-1</p>	<p>(6x1, 1x2, 2x2<sup>1</sup>) c-2</p>	<p>(6x1, 1x2, 2x2<sup>1</sup>) c-3</p>	<p>(6x1, 1x2, 2x2<sup>1</sup>) c-4</p>

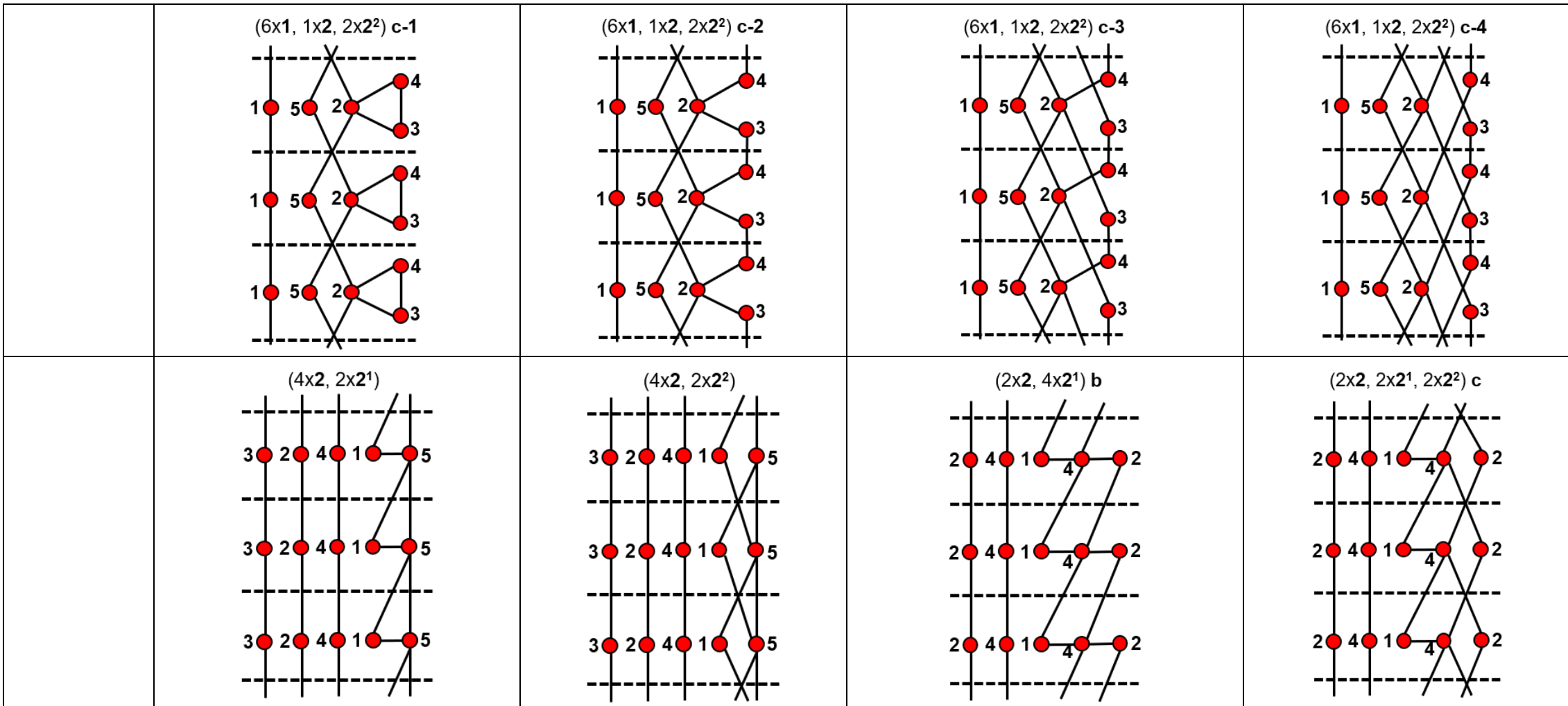

	<p>(2x2, 4x2<sup>2</sup>) b</p>			
${}^2V_4^4V_2$	NG			
${}^2V_4^4V_3$	NG			
${}^2V_4^4V_4$	NG			
${}^2V_5^4V_1$	NG			
${}^2V_5^4V_2$	NG			
${}^2V_5^4V_3$	NG			
${}^2V_6^4V_1$	NG			
${}^2V_6^4V_2$	NG			
${}^3V_r^4V_r$				

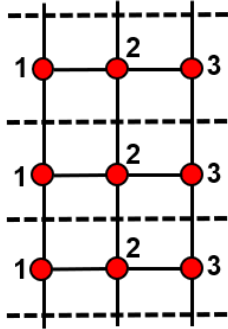
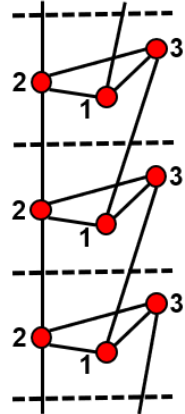
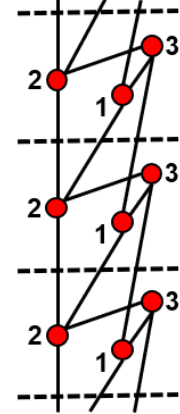
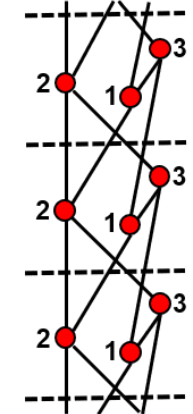
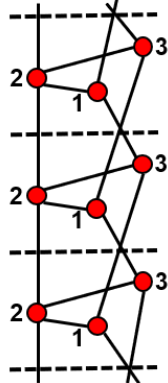
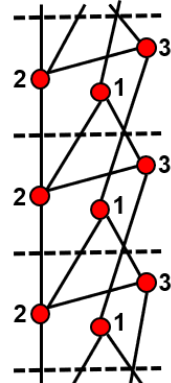
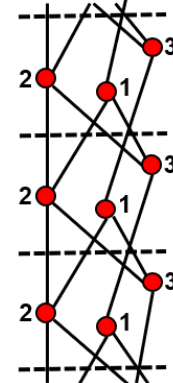
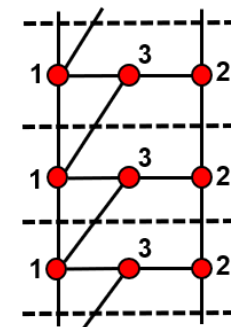
${}^3V_2{}^4V_1$  $(4x1, 3x2)$  $(4x1, 1x2, 2x2^1)$  a $(4x1, 1x2, 2x2^1)$  b $(4x1, 1x2, 2x2^1)$  c $(4x1, 1x2, 2x2^2)$  a $(4x1, 1x2, 2x2^2)$  b $(4x1, 1x2, 2x2^2)$  c $(2x1, 2x2, 2x2^1)$ 

	<p>(2x1, 2x2, 2x2<sup>2</sup>)</p>	<p>(2x1, 4x2<sup>1</sup>) a</p>	<p>(2x1, 4x2<sup>1</sup>) b</p>	<p>(2x1, 4x2<sup>1</sup>) c</p>
	<p>(2x1, 2x2<sup>1</sup>, 2x2<sup>2</sup>) a</p>	<p>(2x1, 2x2<sup>1</sup>, 2x2<sup>2</sup>) b</p>	<p>(2x1, 4x2<sup>2</sup>) a</p>	<p>(2x1, 4x2<sup>2</sup>) b</p>
${}^3V_2{}^4V_2$	NG			
${}^3V_2{}^4V_3$	NG			
${}^3V_2{}^4V_4$	NG			
${}^3V_2{}^4V_5$	NG			
${}^3V_2{}^4V_6$	NG			
${}^3V_4{}^4V_1$	NG			
${}^3V_4{}^4V_2$	NG			

${}^3V_4{}^4V_3$	NG				
${}^3V_4{}^4V_4$	NG				
${}^3V_6{}^4V_1$	NG				
${}^3V_6{}^4V_2$	NG				
<b>Rank 3</b>					
${}^1V_r{}^2V_r{}^3V_r$					
${}^1V_1{}^2V_1{}^3V_1$	<p>(4x1, 1x2)</p>	<p>(2x1, 2x2)</p>	<p>(2x1, 2x2')</p>	<p>(2x1, 2x2'')</p>	
${}^1V_1{}^2V_1{}^3V_3$	NG				
${}^1V_1{}^2V_1{}^3V_5$	NG				
${}^1V_1{}^2V_2{}^3V_1$	<p>(8x1) a</p>	<p>(8x1) b</p>	<p>(8x1) c</p>	<p>(6x1, 1x2)</p>	



	<p>(4x1, 2x2)</p>	<p>(4x1, 2x2<sup>1</sup>)</p>	<p>(4x1, 2x2<sup>2</sup>)</p>	<p>(2x1, 3x2)</p>
	<p>(2x1, 1x2, 2x2<sup>1</sup>) a</p>	<p>(2x1, 1x2, 2x2<sup>2</sup>) a</p>		
${}^1V_1^2V_2^3V_3$	NG			
${}^1V_1^2V_2^3V_5$	NG			

$${}^1V_1^2V_3^3V_1$$

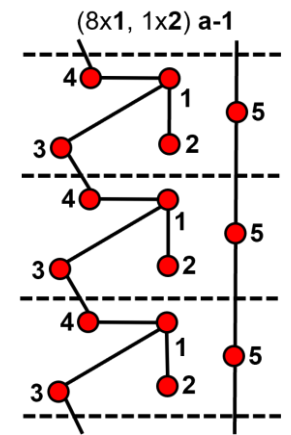
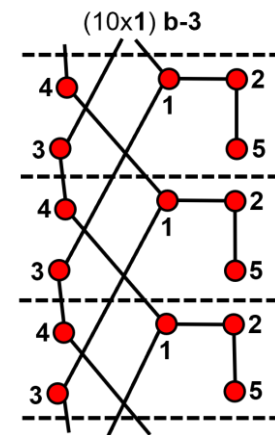
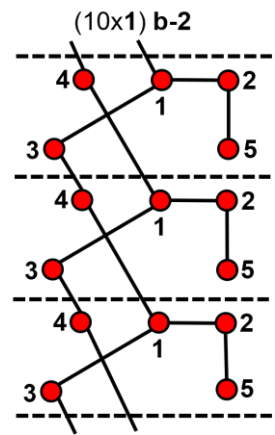
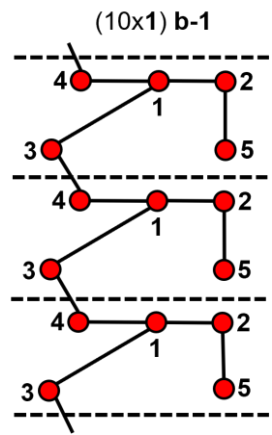
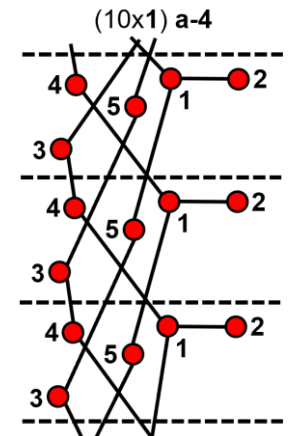
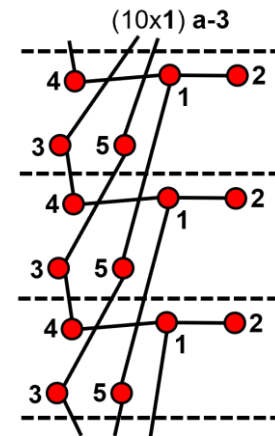
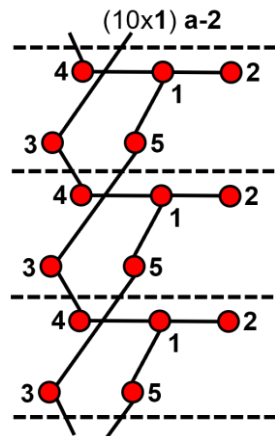
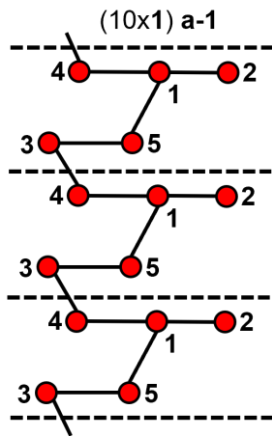

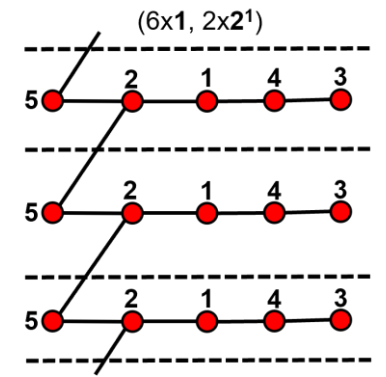
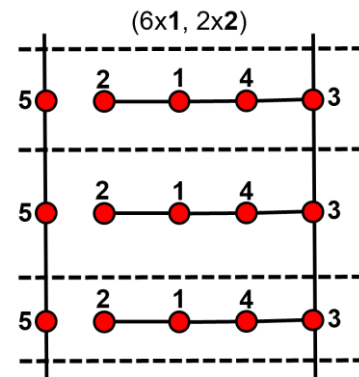
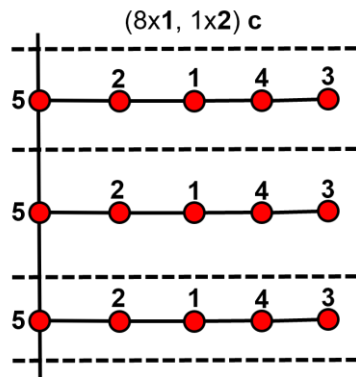
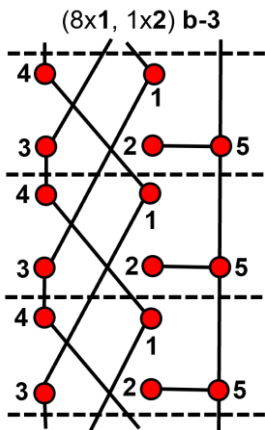
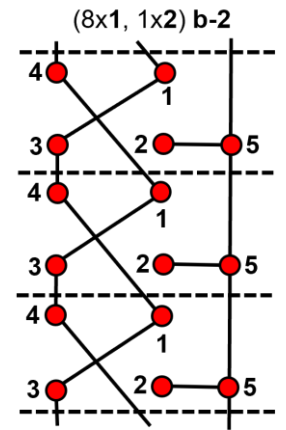
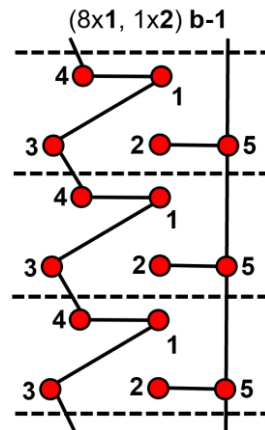
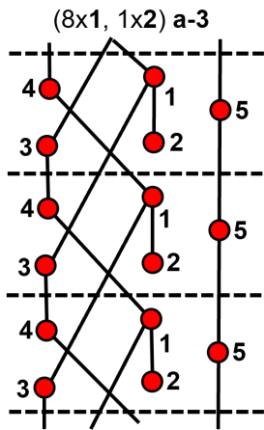
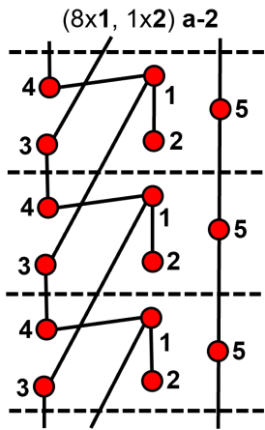

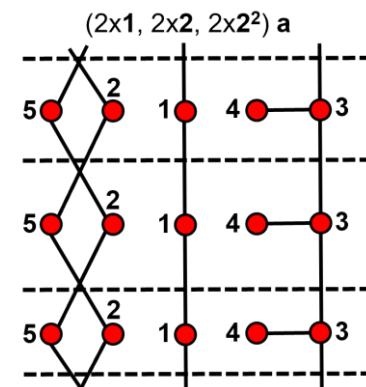
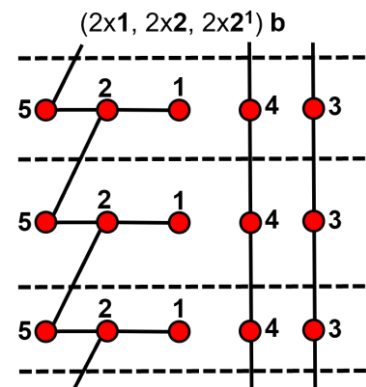
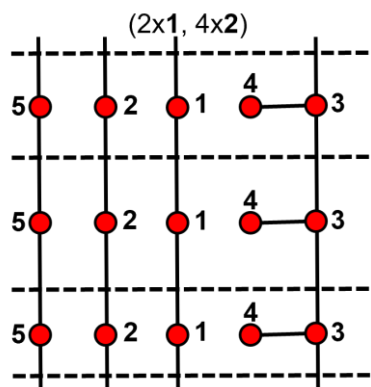
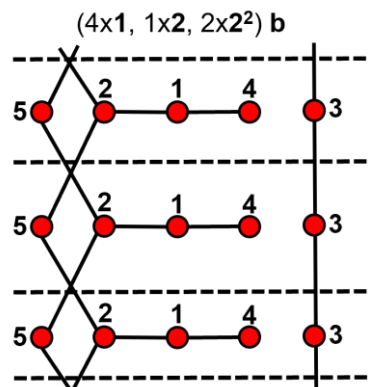
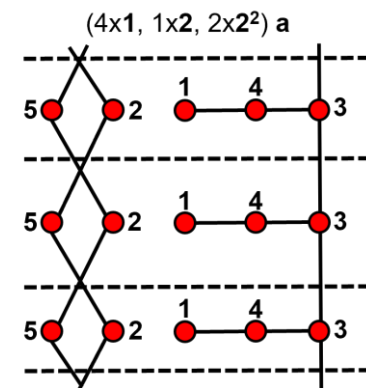
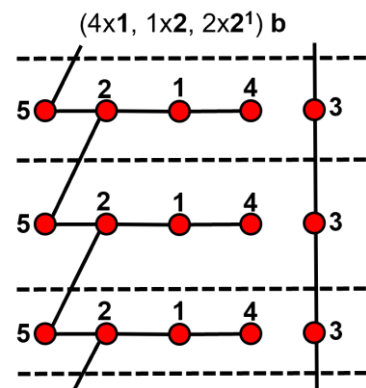
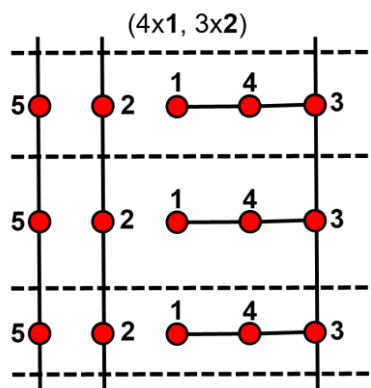
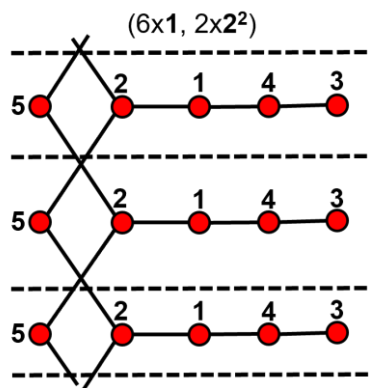

	<p>(2x1, 2x2, 2x2<sup>2</sup>) b</p>	<p>(2x1, 2x2<sup>1</sup>, 2x2<sup>2</sup>) b</p>	<p>(2x1, 4x2<sup>2</sup>)</p>	
${}^1V_1^2V_3^3V_3$	NG			
${}^1V_1^2V_4^3V_1$	NG			
${}^1V_1^2V_4^3V_3$	NG			
${}^1V_1^2V_5^3V_1$	NG			
${}^1V_1^2V_6^3V_1$	NG			
${}^1V_1^2V_6^3V_3$	NG			

$${}^1V_2^2V_1^3V_2$$

(10x1) a

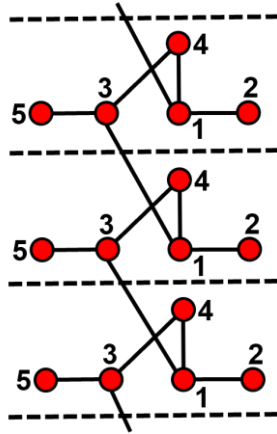

(10x1) b

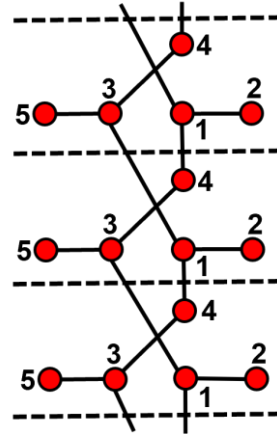

(10x1) c

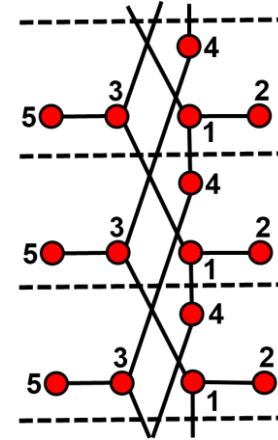

(8x1, 1x2) a

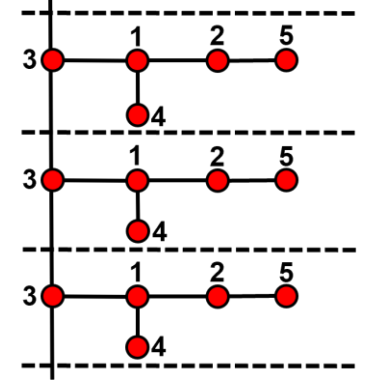

(8x1, 1x2) b

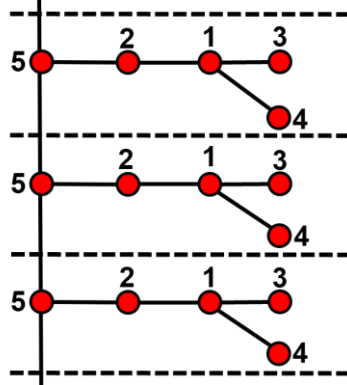

(6x1, 2x2) a

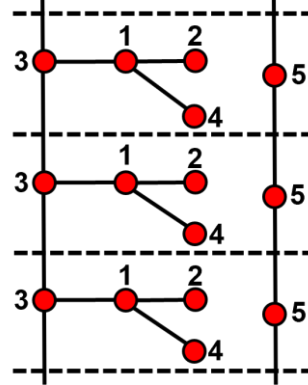

(6x1, 2x2) b

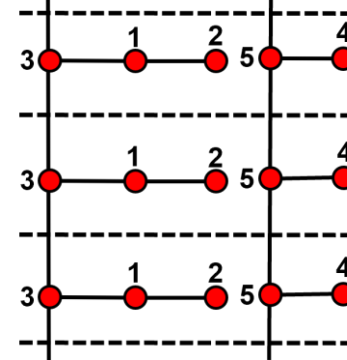

(6x1, 2x2) c

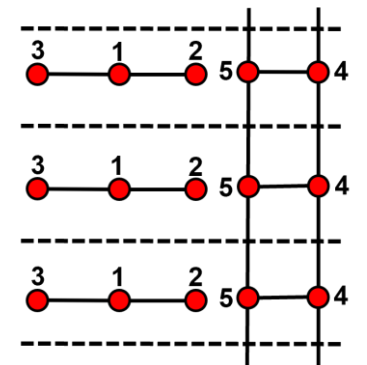

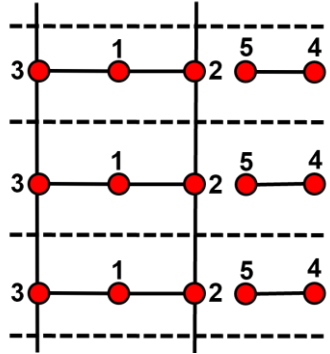
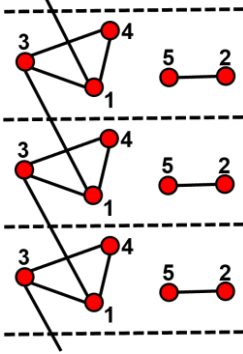
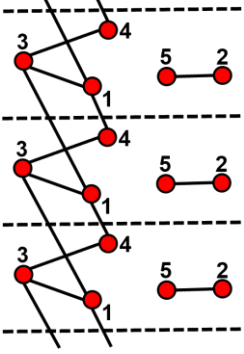
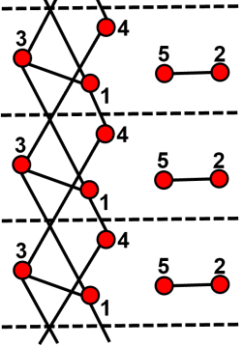
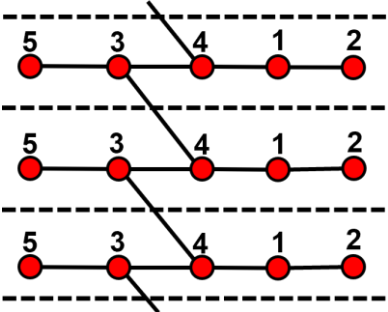
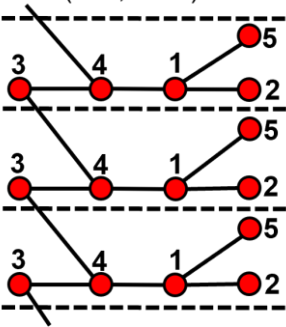
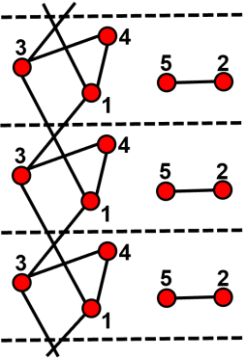
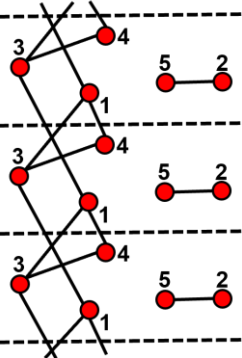
	<p>(6x1, 2x2) d</p> 	<p>(6x1, 2x2<sup>1</sup>) a-1</p> 	<p>(6x1, 2x2<sup>2</sup>) a-2</p> 	<p>(6x1, 2x2<sup>3</sup>) a-3</p> 
	<p>(6x1, 2x2<sup>1</sup>) b</p> 	<p>(6x1, 2x2<sup>1</sup>) c</p> 	<p>(6x1, 2x2<sup>2</sup>) a-1</p> 	<p>(6x1, 2x2<sup>2</sup>) a-2</p> 

	<p>(6x1, 2x2<sup>2</sup>) a-3</p>	<p>(6x1, 2x2<sup>2</sup>) b</p>	<p>(6x1, 2x2<sup>2</sup>) c</p>	<p>(4x1, 3x2) a</p>
	<p>(4x1, 3x2) b</p>	<p>(4x1, 1x2, 2x2<sup>1</sup>) a</p>	<p>(4x1, 1x2, 2x2<sup>1</sup>) b</p>	<p>(4x1, 1x2, 2x2<sup>2</sup>) a</p>



	<p>(4x1, 1x2, 2x2<sup>2</sup>) b</p>	<p>(4x1, 1x2, 2x2<sup>2</sup>) c</p>		
${}^1V_2{}^2V_1{}^3V_4$	NG			
${}^1V_2{}^2V_2{}^3V_2$	NG			
${}^1V_2{}^2V_2{}^3V_4$	NG			
${}^1V_2{}^2V_3{}^3V_2$	NG			
${}^1V_2{}^2V_4{}^3V_2$	NG			
${}^1V_3{}^2V_1{}^3V_1$	<p>(6x1, 1x2) a</p>	<p>(6x1, 1x2) b</p>	<p>(6x1, 1x2) c</p>	<p>(4x1, 2x2)</p>

	<p>(4x1, 2x2<sup>1</sup>)</p>	<p>(4x1, 2x2<sup>2</sup>)</p>		
${}^1V_3{}^2V_1{}^3V_3$	NG			
${}^1V_3{}^2V_2{}^3V_1$	<p>(10x1) a</p>	<p>(10x1) b</p>	<p>(10x1) c</p>	<p>(8x1, 1x2) a</p>

	<p>(8x1, 1x2) b</p>	<p>(8x1, 1x2) c</p>	<p>(8x1, 1x2) d</p>	<p>(6x1, 2x2) a</p>
	<p>(6x1, 2x2) b</p>	<p>(6x1, 2x2) c</p>	<p>(6x1, 2x2<sup>1</sup>) a</p>	<p>(6x1, 2x2<sup>1</sup>) b</p>

	<p>(6x1, 2x2<sup>2</sup>) a</p>	<p>(6x1, 2x2<sup>2</sup>) b</p>	<p>(6x1, 2x2<sup>2</sup>) c</p>	<p>(4x1, 3x2)</p>
	<p>(4x1, 1x2, 2x2<sup>1</sup>) a</p>	<p>(4x1, 1x2, 2x2<sup>2</sup>) a</p>	<p>(4x1, 1x2, 2x2<sup>2</sup>) b</p>	
${}^1V_3^2V_2^3V_3$	NG			
${}^1V_3^2V_3^3V_1$	NG			
${}^1V_3^2V_4^3V_1$	NG			
${}^1V_4^2V_1^3V_2$	NG			
${}^1V_4^2V_2^3V_2$	NG			

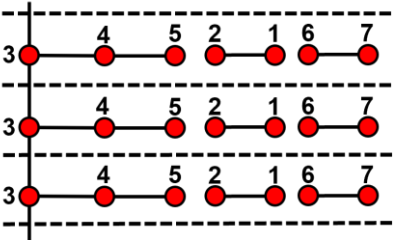
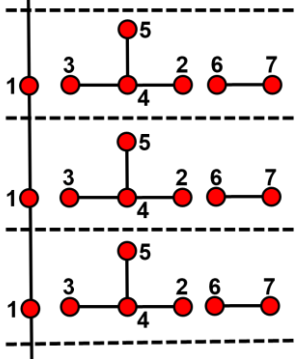
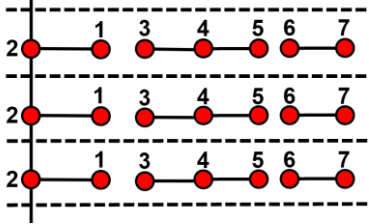
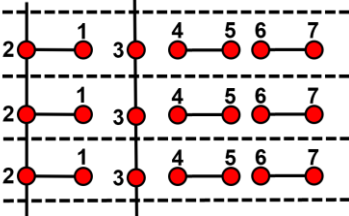
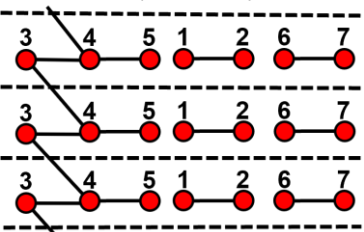
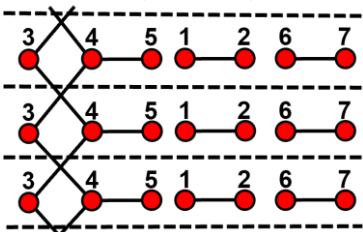
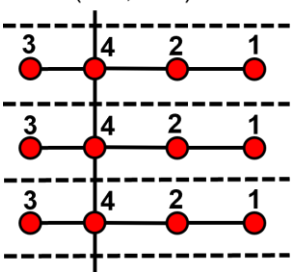
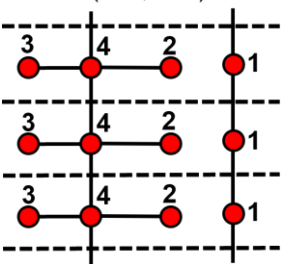
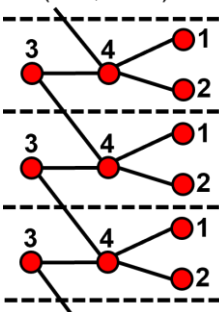
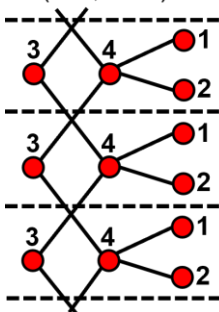
${}^1V_5^2V_1^3V_1$	<p>(8x1, 1x2) a</p> 	<p>(8x1, 1x2) b</p> 	<p>(8x1, 1x2) c</p> 	<p>(6x1, 2x2)</p> 
	<p>(6x1, 2x2<sup>1</sup>)</p> 	<p>(6x1, 2x2<sup>2</sup>)</p> 		
${}^1V_5^2V_2^3V_1$	NG			
${}^1V_r^2V_r^4V_r$				
${}^1V_2^2V_1^4V_1$	<p>(6x1, 1x2)</p> 	<p>(4x1, 2x2)</p> 	<p>(4x1, 2x2<sup>1</sup>)</p> 	<p>(4x1, 2x2<sup>2</sup>)</p> 

	<p>(2x1, 1x2, 2x2<sup>1</sup>)</p>	<p>(2x1, 1x2, 2x2<sup>2</sup>)</p>		
${}^1V_2^2V_1^4V_2$	<p>(10x1, 1x2) a</p>	<p>(10x1, 1x2) b</p>	<p>(10x1, 1x2) c</p>	<p>(10x1, 1x2) d</p>
	<p>(8x1, 2x2) a</p>	<p>(8x1, 2x2) b-1</p>	<p>(8x1, 2x2) b-2</p>	<p>(8x1, 2x2) b-3</p>

	<p>(8x1, 2x2) b-4</p>	<p>(8x1, 2x2) c</p>	<p>(8x1, 2x2^1) a</p>	<p>(8x1, 2x2^1) b</p>
	<p>(8x1, 2x2^1) c</p>	<p>(8x1, 2x2^1) d</p>	<p>(8x1, 2x2^2) a</p>	<p>(8x1, 2x2^2) b</p>
	<p>(8x1, 2x2^2) c</p>	<p>(6x1, 3x2)</p>	<p>(6x1, 1x2, 2x2^1) a</p>	<p>(6x1, 1x2, 2x2^1) b</p>

	<p>(6x1, 1x2, 2x2<sup>2</sup>) a</p>	<p>(6x1, 1x2, 2x2<sup>2</sup>) b</p>	<p>(4x1, 2x2, 2x2<sup>1</sup>) a</p>	<p>(4x1, 2x2, 2x2<sup>1</sup>) b</p>
	<p>(4x1, 2x2, 2x2<sup>1</sup>) c</p>	<p>(4x1, 2x2, 2x2<sup>2</sup>) a</p>	<p>(4x1, 2x2, 2x2<sup>2</sup>) b</p>	<p>(4x1, 2x2, 2x2<sup>2</sup>) c</p>
	<p>(4x1, 4x2<sup>1</sup>)</p>	<p>(4x1, 2x2<sup>1</sup>, 2x2<sup>2</sup>) a</p>	<p>(4x1, 2x2<sup>1</sup>, 2x2<sup>2</sup>) b</p>	<p>(4x1, 4x2<sup>2</sup>)</p>



	<p>(2x1, 3x2, 2x2<sup>1</sup>)</p>	<p>(2x1, 3x2, 2x2<sup>2</sup>)</p>	<p>(2x1, 1x2, 4x2<sup>1</sup>)</p>	<p>(2x1, 1x2, 2x2<sup>1</sup>, 2x2<sup>2</sup>) a</p>
	<p>(2x1, 1x2, 2x2<sup>1</sup>, 2x2<sup>2</sup>) b</p>	<p>(2x1, 1x2, 4x2<sup>2</sup>)</p>		
${}^1V_2{}^2V_1{}^4V_3$	NG			
${}^1V_2{}^2V_1{}^4V_4$	NG			
${}^1V_2{}^2V_1{}^4V_5$	NG			

${}^1V_2{}^2V_2{}^4V_1$

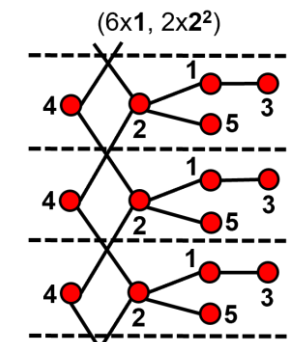
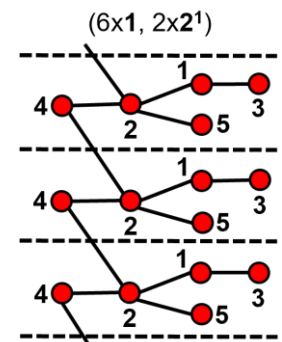
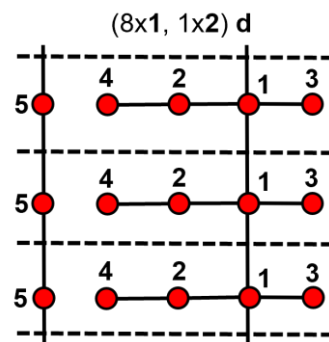
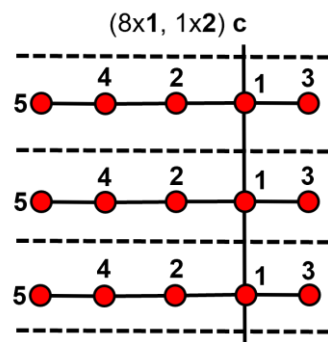
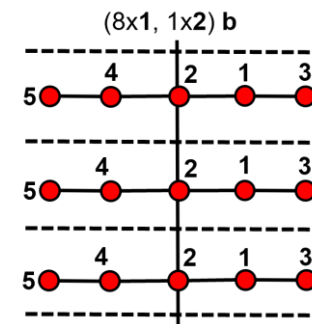
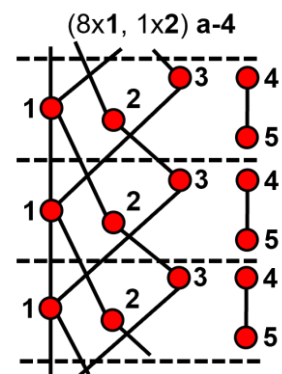
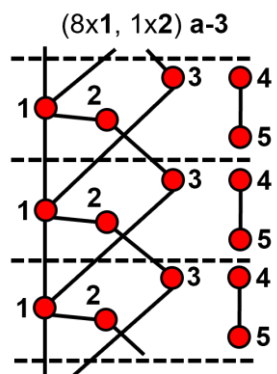
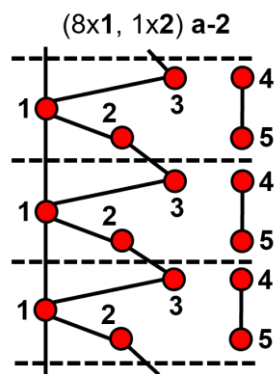
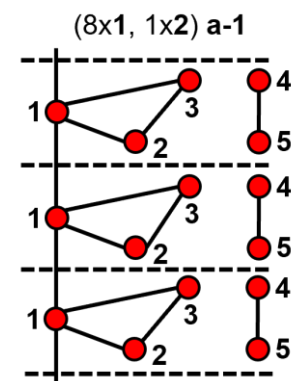
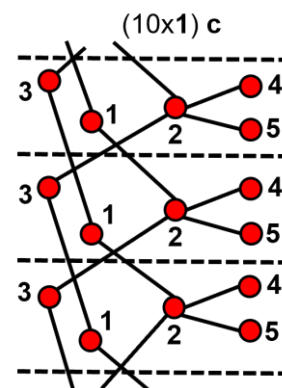
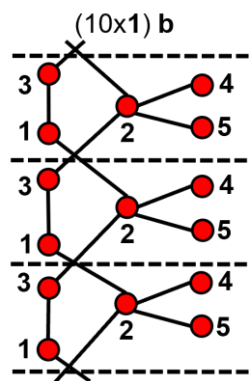
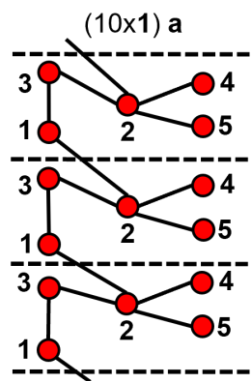

	<p>(4x1, 3x2)</p>	<p>(4x1, 1x2, 2x2<sup>1</sup>) a</p>	<p>(4x1, 1x2, 2x2<sup>1</sup>) c</p>	<p>(4x1, 1x2, 2x2<sup>2</sup>) a</p>
	<p>(4x1, 1x2, 2x2<sup>2</sup>) b</p>	<p>(4x1, 1x2, 2x2<sup>2</sup>) c</p>	<p>(2x1, 2x2, 2x2<sup>1</sup>)</p>	<p>(2x1, 2x2, 2x2<sup>2</sup>)</p>
	<p>(2x1, 4x2<sup>1</sup>)</p>	<p>(2x1, 2x2<sup>1</sup>, 2x2<sup>2</sup>)</p>	<p>(2x1, 4x2<sup>2</sup>)</p>	
${}^1V_2^2V_2^4V_2$	NG			

${}^1V_2^2V_2^4V_3$	NG				
${}^1V_2^2V_2^4V_4$	NG				
${}^1V_2^2V_3^4V_1$	NG				
${}^1V_2^2V_3^4V_2$	NG				
${}^1V_2^2V_3^4V_3$	NG				
${}^1V_2^2V_4^4V_1$	NG				
${}^1V_2^2V_4^4V_2$	NG				
${}^1V_2^2V_5^4V_1$	NG				
${}^1V_4^2V_1^4V_1$	<p>(8x1, 1x2) a</p>	<p>(8x1, 1x2) b</p>	<p>(8x1, 1x2) c</p>	<p>(6x1, 2x2)</p>	
	<p>(6x1, 2x2<sup>1</sup>)</p>	<p>(6x1, 2x2<sup>2</sup>)</p>	<p>(4x1, 1x2, 2x2<sup>1</sup>)</p>	<p>(4x1, 1x2, 2x2<sup>2</sup>)</p>	

${}^1V_4^2V_1^4V_2$	NG				
${}^1V_4^2V_1^4V_3$	NG				
${}^1V_4^2V_2^4V_1$	NG				
${}^1V_4^2V_2^4V_2$	NG				
${}^1V_4^2V_3^4V_1$	NG				
${}^1V_6^2V_1^4V_1$	NG				
${}^1V_r^3V_r^4V_r$					
${}^1V_1^3V_1^4V_1$	<p>(4x1, 2x2)</p>	<p>(2x1, 1x2, 2x2<sup>1</sup>)</p>	<p>(2x1, 1x2, 2x2<sup>2</sup>)</p>		
${}^1V_1^3V_1^4V_2$	<p>(8x1, 2x2) a</p>	<p>(8x1, 2x2) b</p>	<p>(8x1, 2x2) c</p>	<p>(8x1, 2x2) d</p>	

	<p>(6x1, 3x2)</p>	<p>(6x1, 1x2, 2x2<sup>1</sup>) a</p>	<p>(6x1, 1x2, 2x2<sup>1</sup>) b</p>	<p>(6x1, 1x2, 2x2<sup>1</sup>) c</p>
	<p>(6x1, 1x2, 2x2<sup>2</sup>) a</p>	<p>(6x1, 1x2, 2x2<sup>2</sup>) b</p>	<p>(6x1, 1x2, 2x2<sup>2</sup>) c</p>	<p>(4x1, 2x2, 2x2<sup>1</sup>) a</p>
	<p>(4x1, 2x2, 2x2<sup>1</sup>) b</p>	<p>(4x1, 2x2, 2x2<sup>2</sup>) a</p>	<p>(4x1, 2x2, 2x2<sup>2</sup>) b</p>	<p>(4x1, 4x2<sup>1</sup>) a</p>

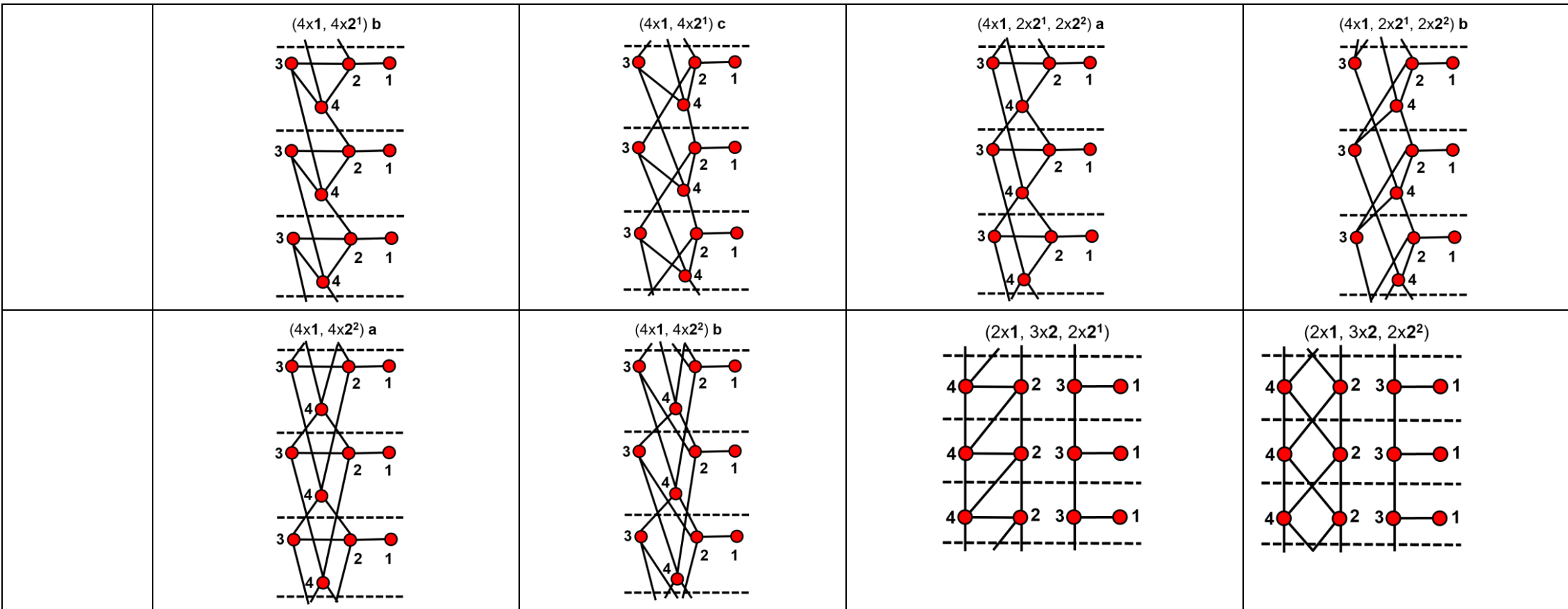

	<p>(2x1, 1x2, 4x2<sup>1</sup>)</p>	<p>(2x1, 1x2, 2x2<sup>1</sup>, 2x2<sup>2</sup>)</p>	<p>(2x1, 1x2, 4x2<sup>2</sup>)</p>	
${}^1V_1{}^3V_1{}^4V_3$	NG			
${}^1V_1{}^3V_1{}^4V_4$	NG			
${}^1V_1{}^3V_1{}^4V_5$	NG			
${}^1V_1{}^3V_1{}^4V_6$	NG			
${}^1V_1{}^3V_3{}^4V_1$	<p>(14x1) a</p>	<p>(14x1) b</p>	<p>(14x1) c</p>	<p>(14x1) d</p>



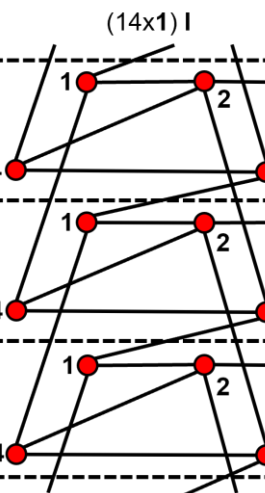
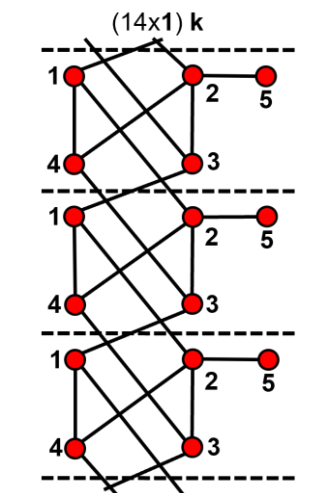
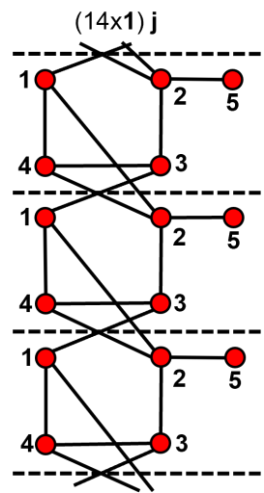
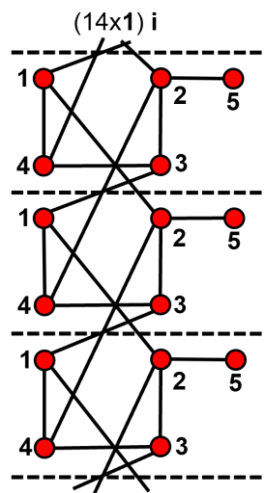
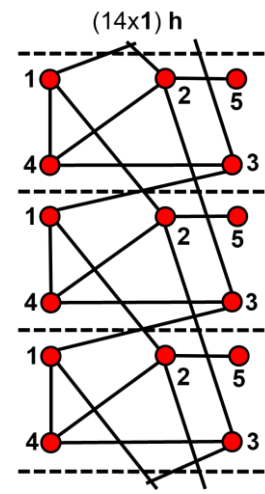
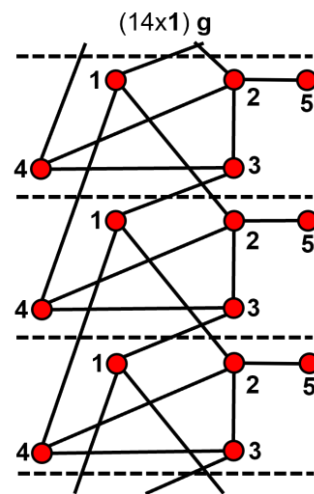
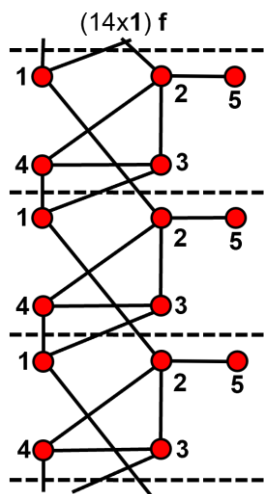
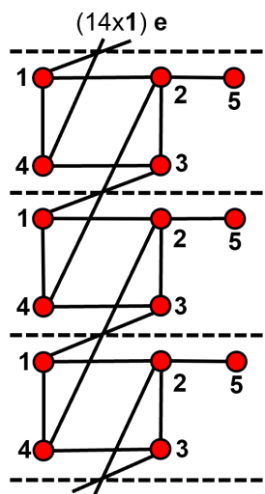

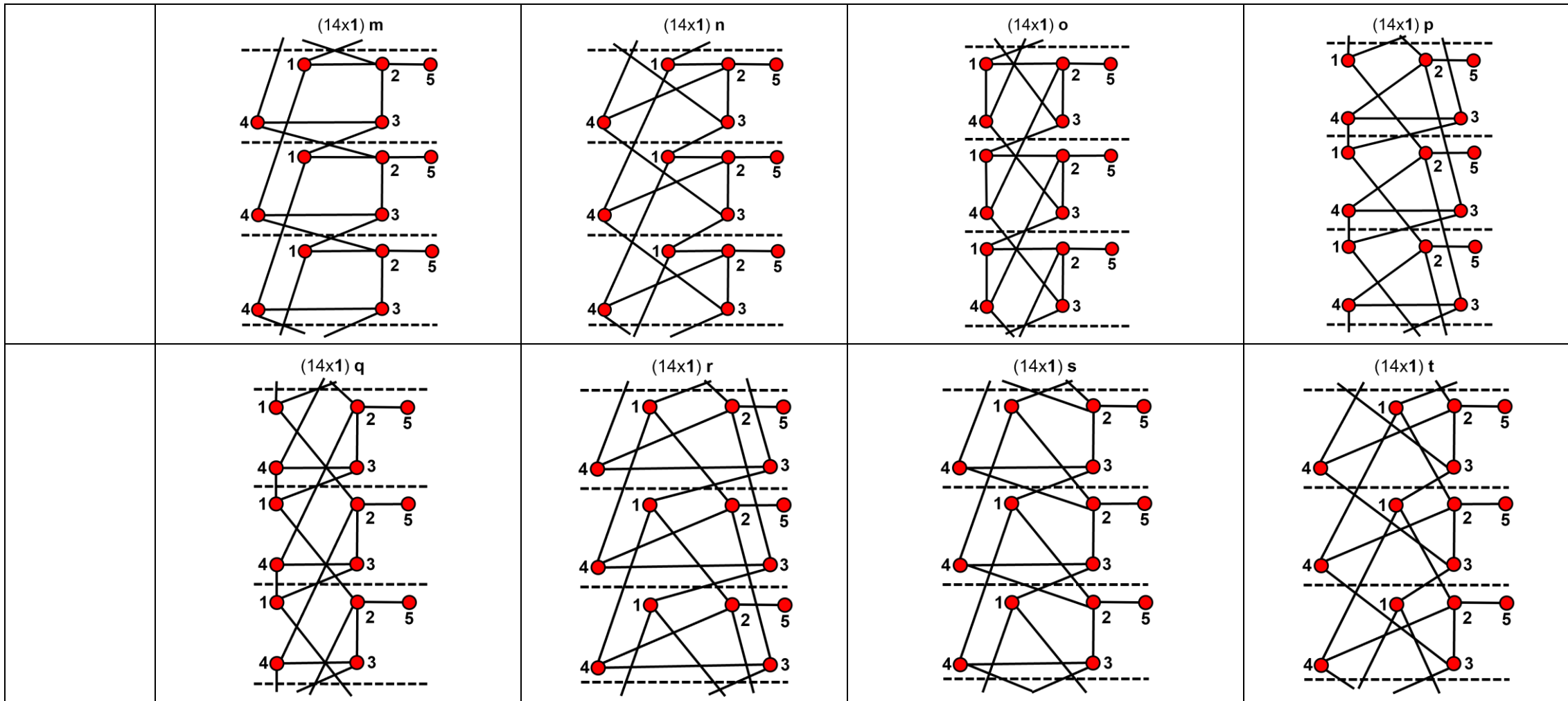

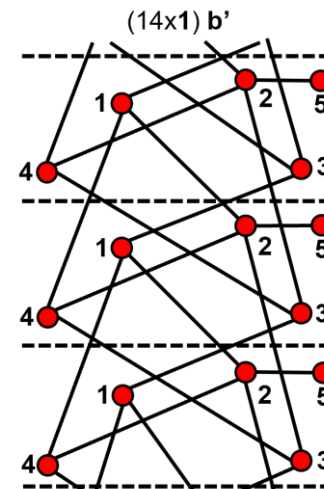
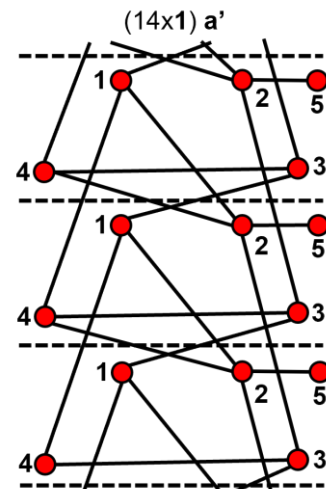
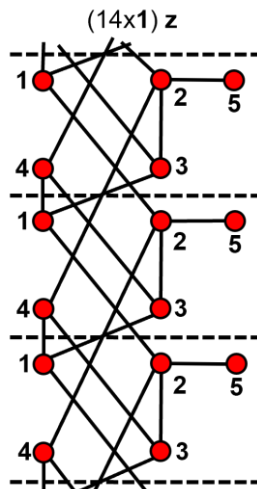
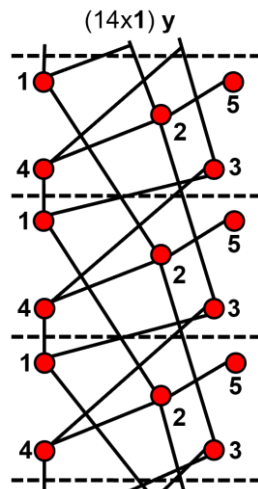
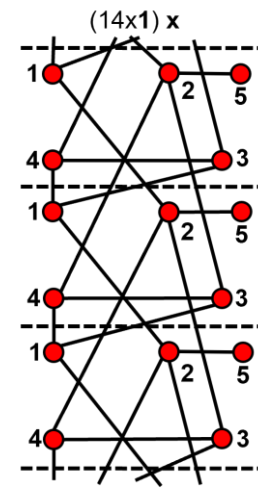
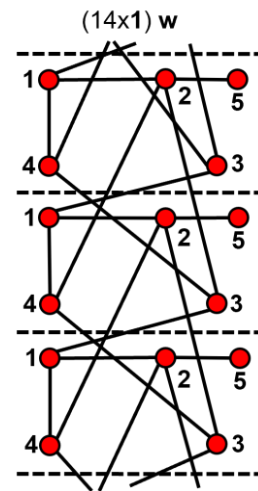
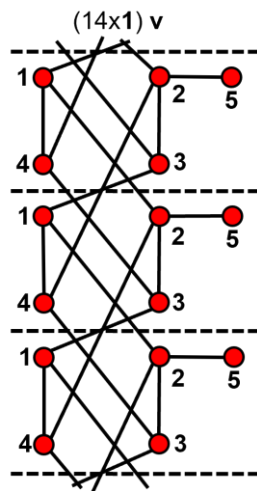
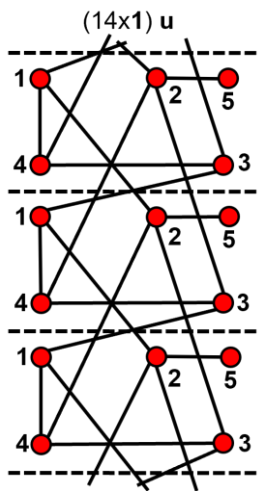

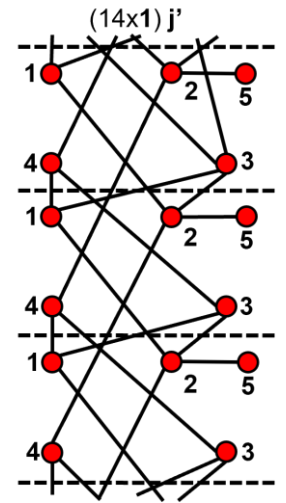
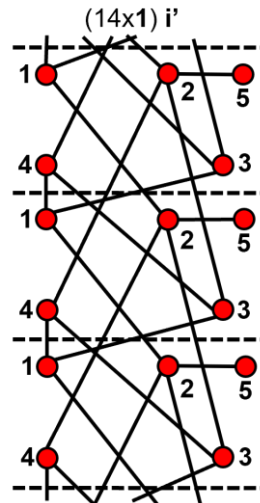
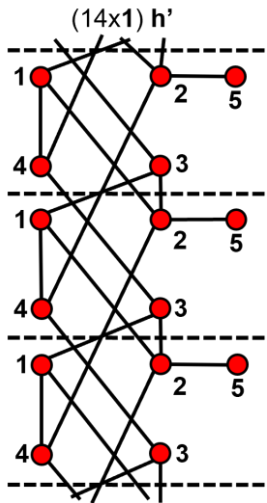
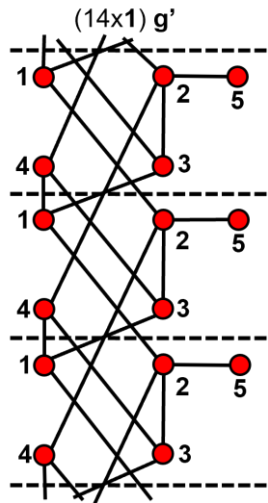
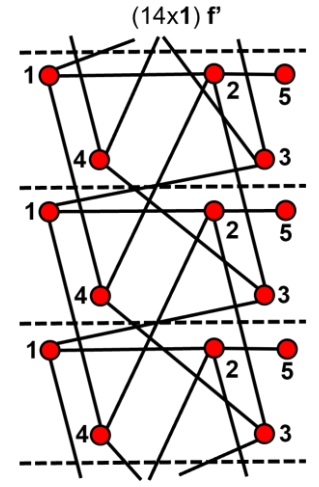
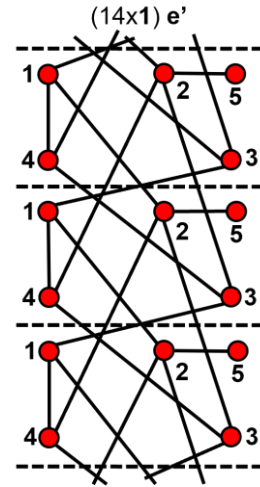
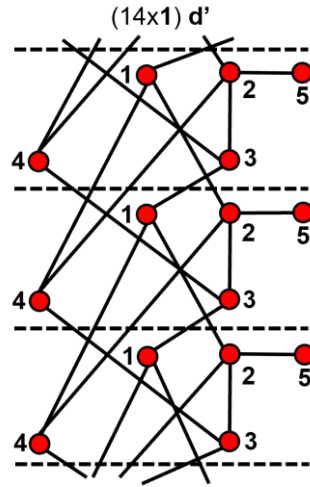
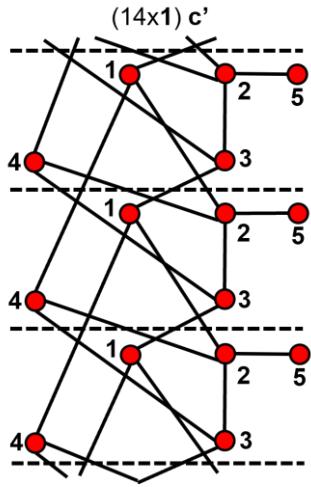

(12x1, 1x2) a

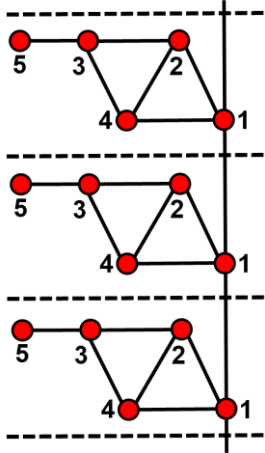

(12x1, 1x2) b

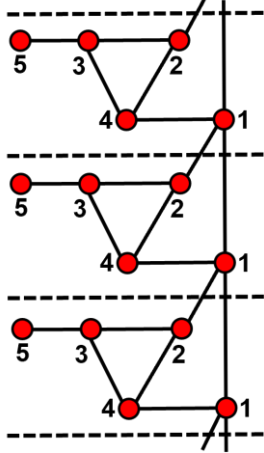

(12x1, 1x2) c

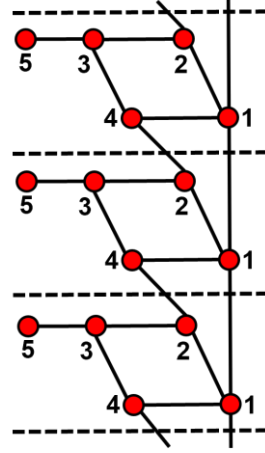

(12x1, 1x2) d

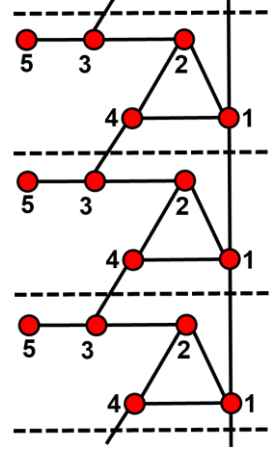

(12x1, 1x2) e

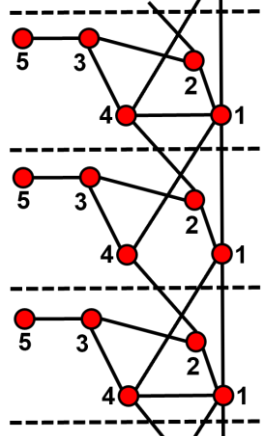

(12x1, 1x2) f

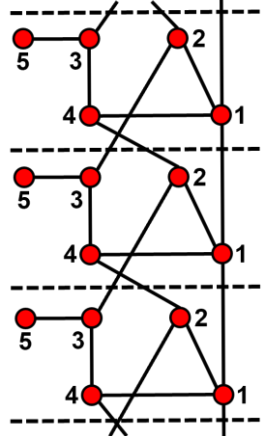

(12x1, 1x2) g

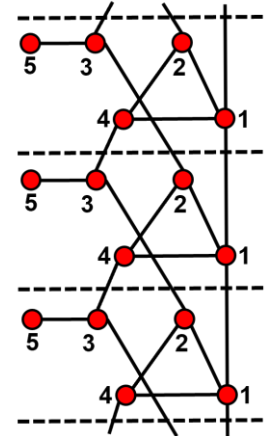

(12x1, 1x2) h

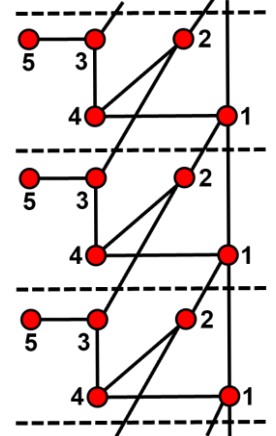

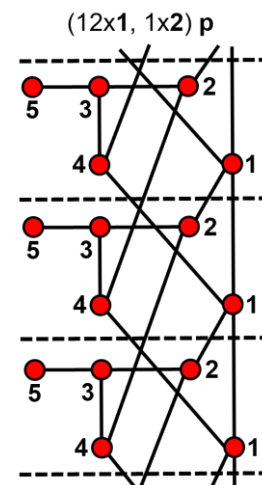
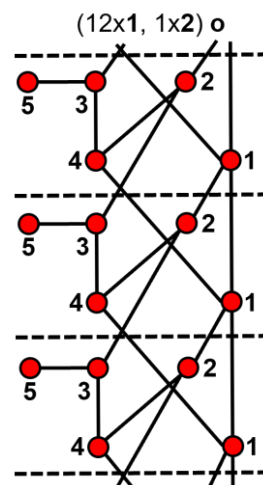
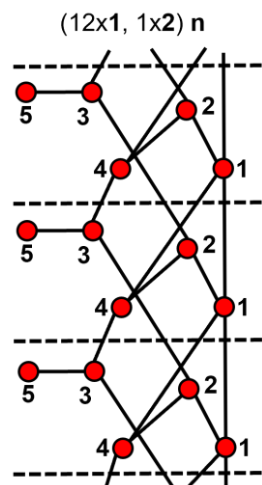
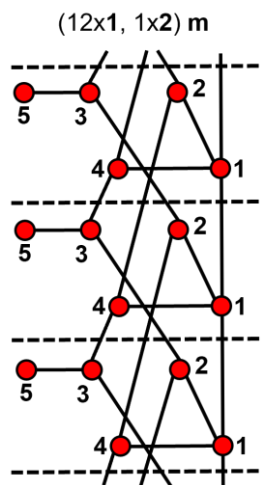
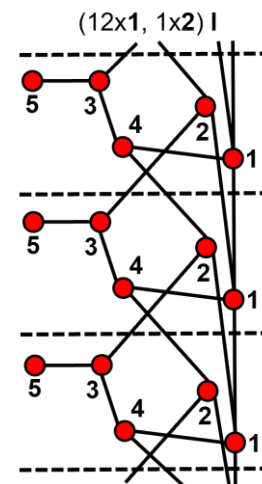
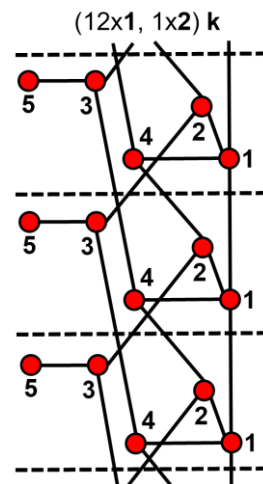
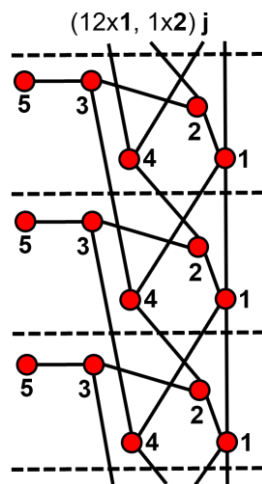
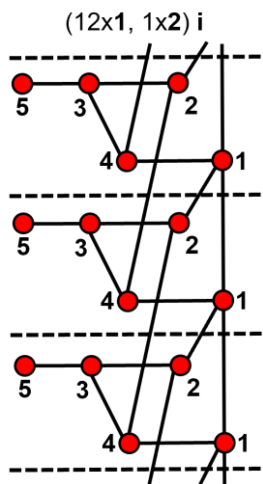



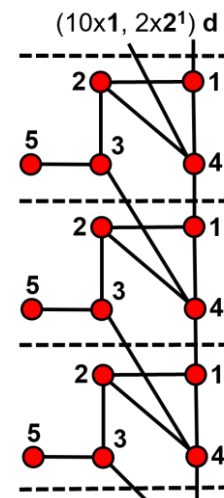
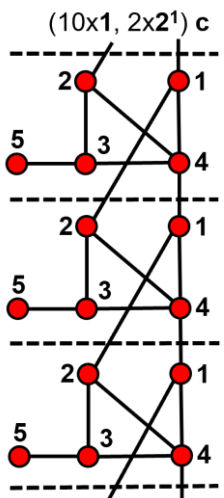
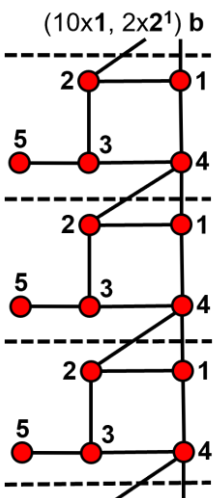
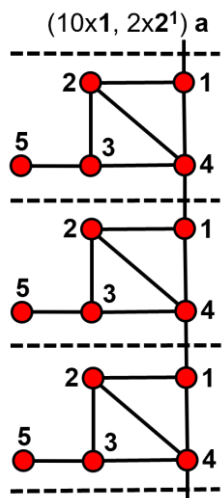
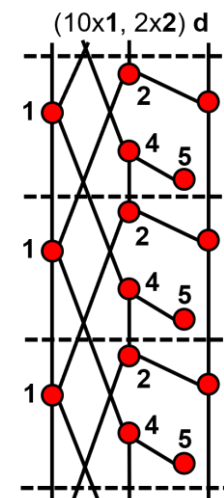
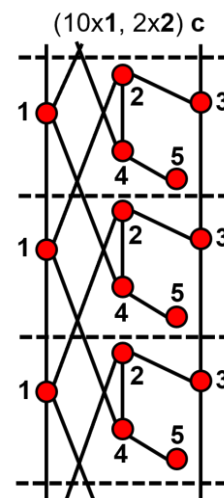
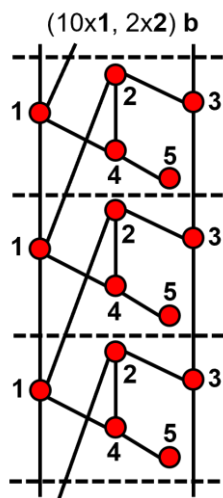
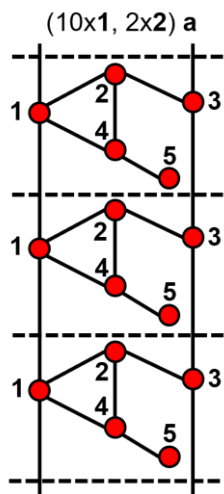



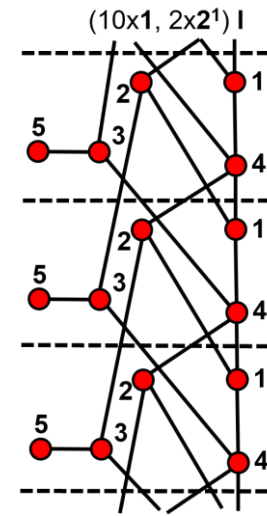
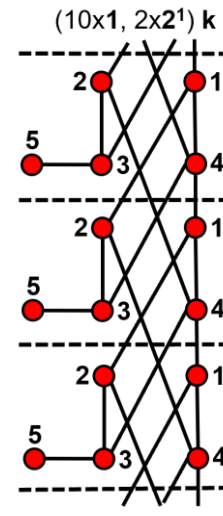
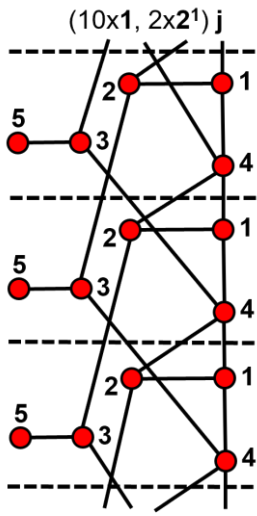
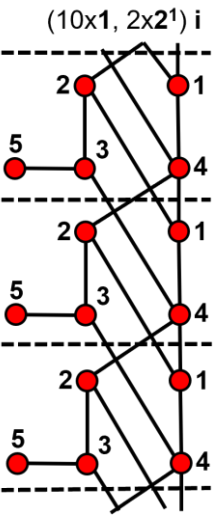
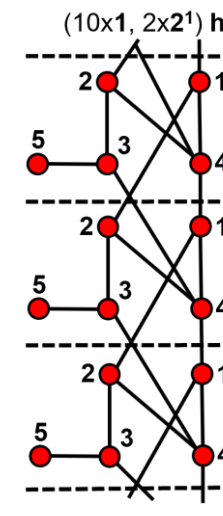
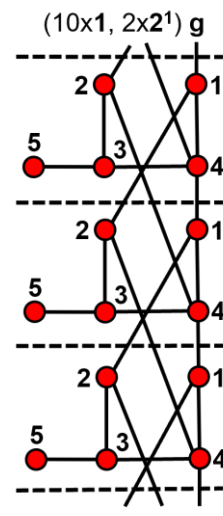
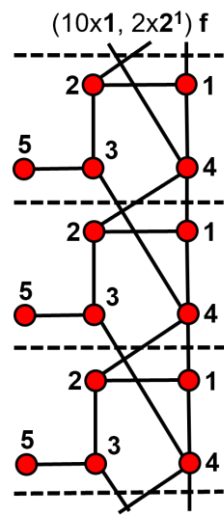
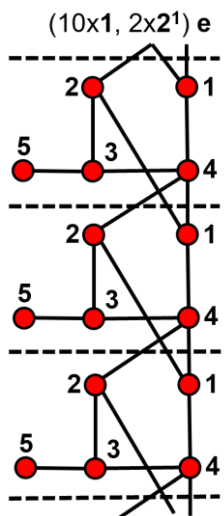

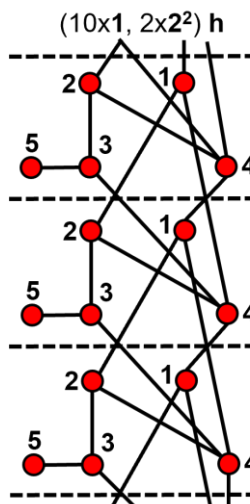
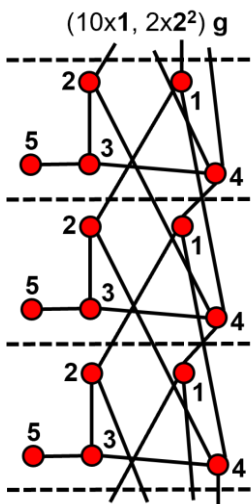
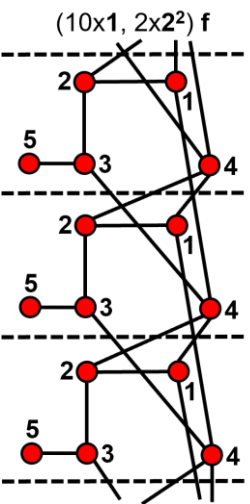
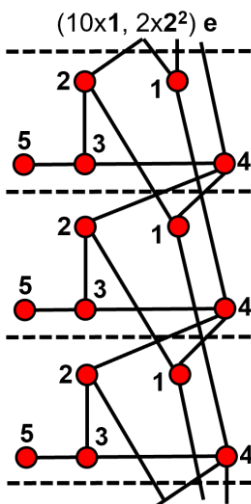
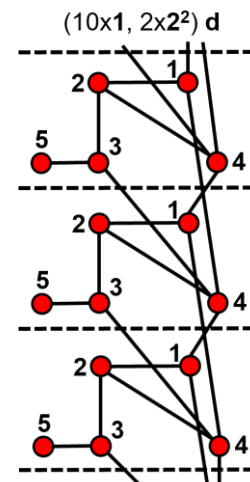
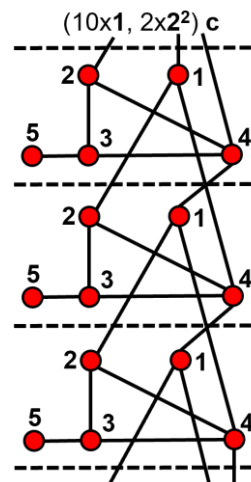
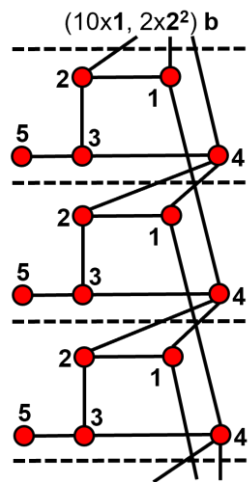
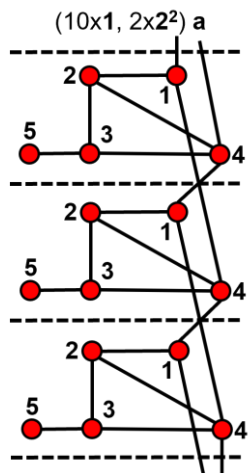

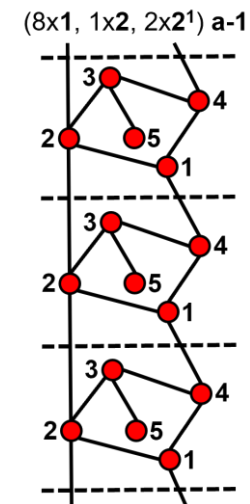
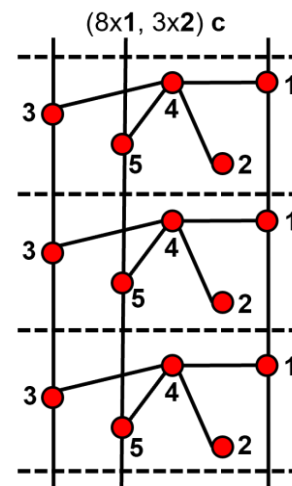
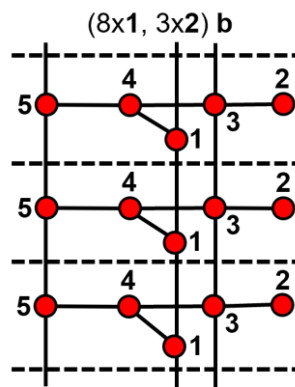
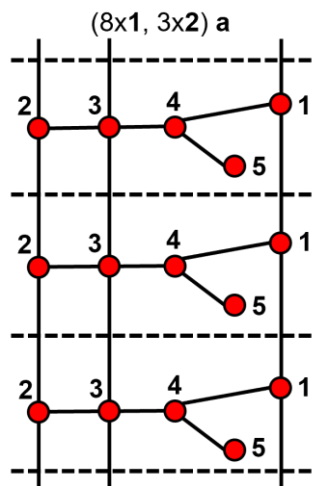
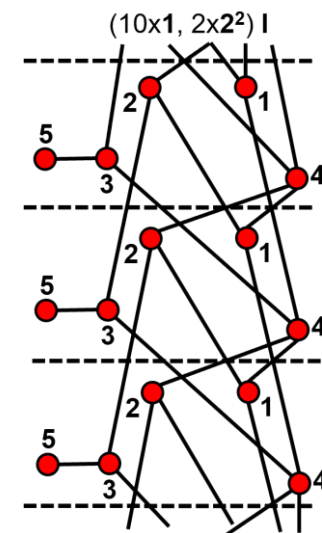
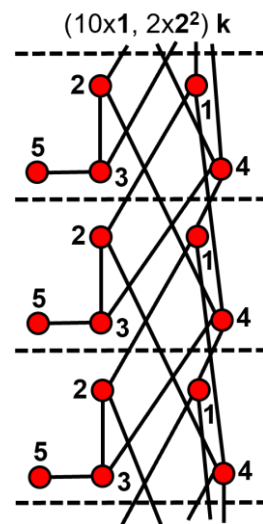
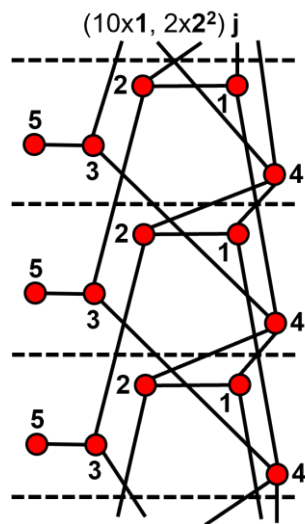
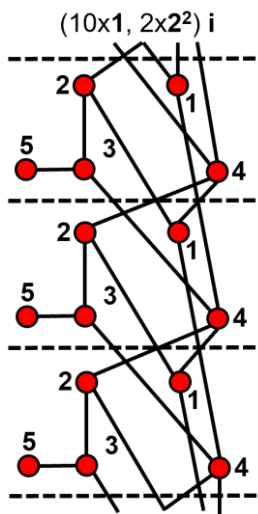

(8x1, 1x2, 2x2<sup>1</sup>) a-2

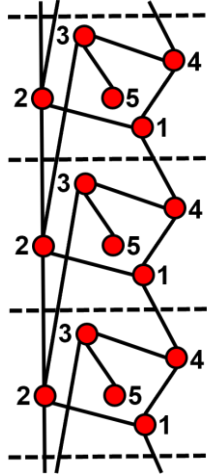

(8x1, 1x2, 2x2<sup>1</sup>) a-3

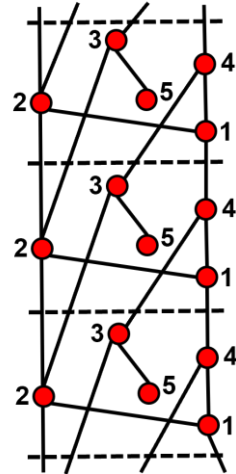

(8x1, 1x2, 2x2<sup>1</sup>) a-4

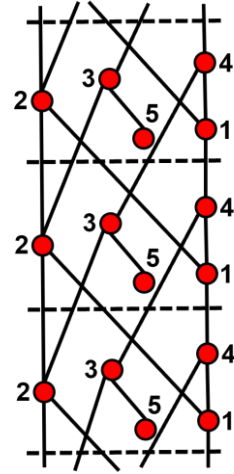

(8x1, 1x2, 2x2<sup>1</sup>) b-1

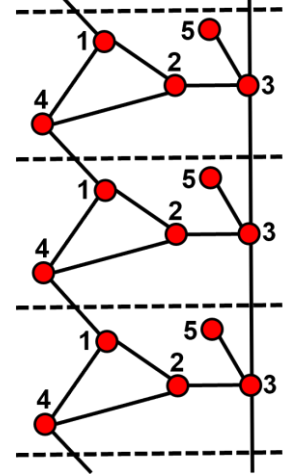

(8x1, 1x2, 2x2<sup>1</sup>) b-2

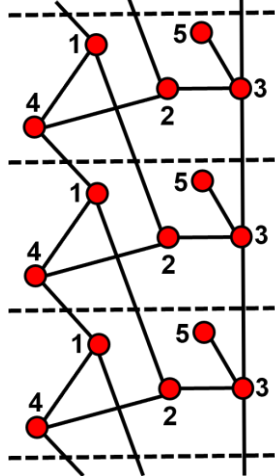

(8x1, 1x2, 2x2<sup>1</sup>) b-3

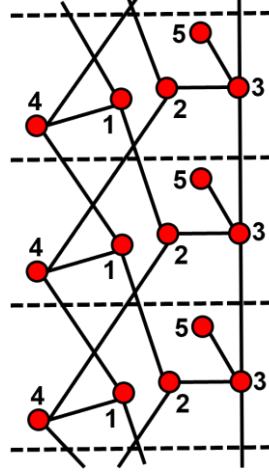

(8x1, 1x2, 2x2<sup>1</sup>) c-1

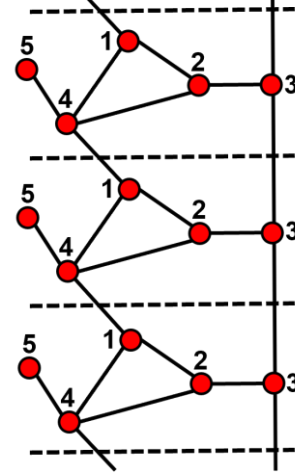

(8x1, 1x2, 2x2<sup>1</sup>) c-2

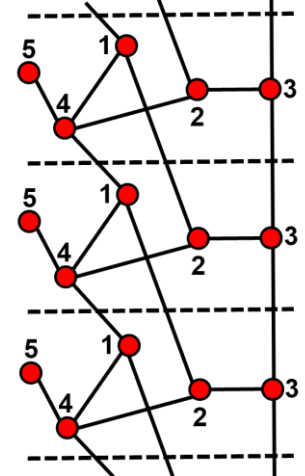

(8x1, 1x2, 2x2<sup>1</sup>) c-3

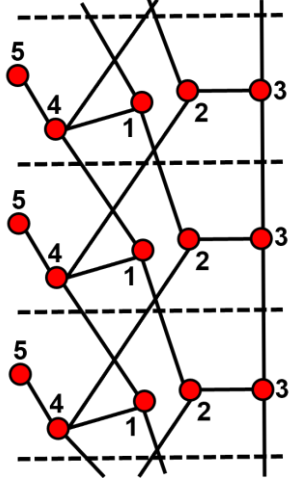

(8x1, 1x2, 2x2<sup>1</sup>) d-1

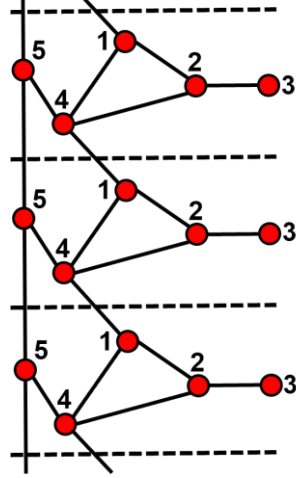

(8x1, 1x2, 2x2<sup>1</sup>) d-2

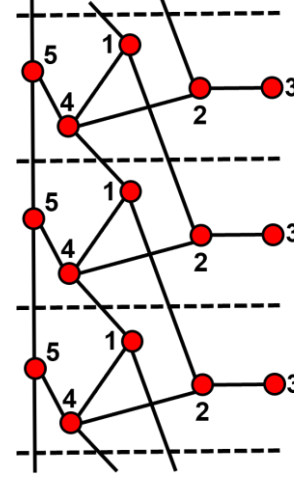

(8x1, 1x2, 2x2<sup>1</sup>) d-3

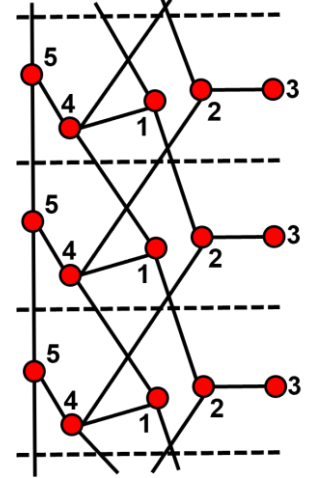

(8x1, 1x2, 2x2<sup>1</sup>) e-1

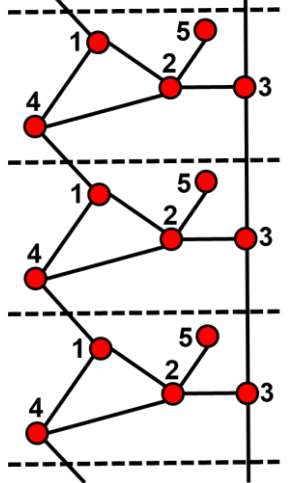

(8x1, 1x2, 2x2<sup>1</sup>) e-2

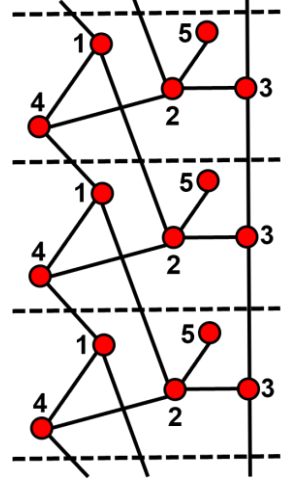

(8x1, 1x2, 2x2<sup>1</sup>) e-3

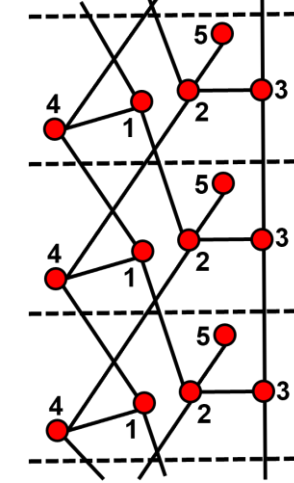

(8x1, 1x2, 2x2<sup>2</sup>) a-1

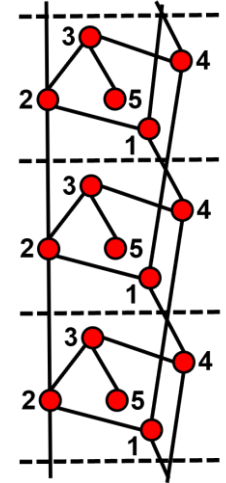

(8x1, 1x2, 2x2<sup>2</sup>) a-2

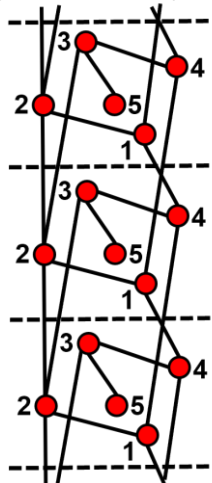

(8x1, 1x2, 2x2<sup>2</sup>) a-3

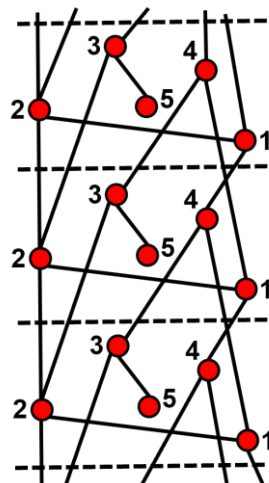

(8x1, 1x2, 2x2<sup>2</sup>) a-4

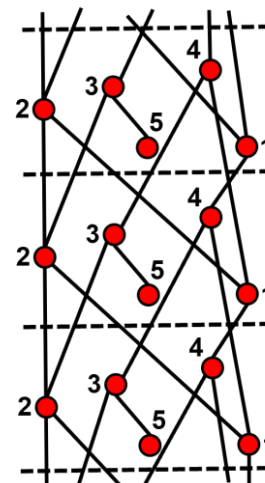

(8x1, 1x2, 2x2<sup>2</sup>) b-1

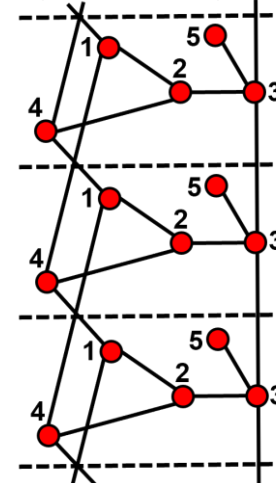

(8x1, 1x2, 2x2<sup>2</sup>) b-2

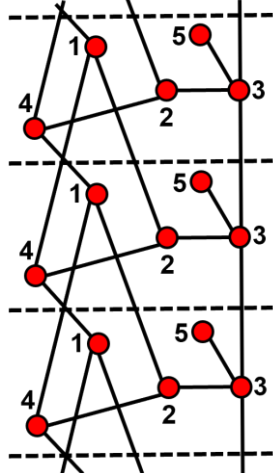

(8x1, 1x2, 2x2<sup>2</sup>) b-3

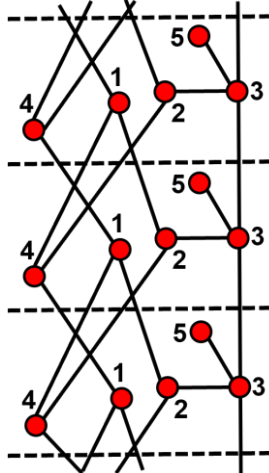

(8x1, 1x2, 2x2<sup>2</sup>) c-1

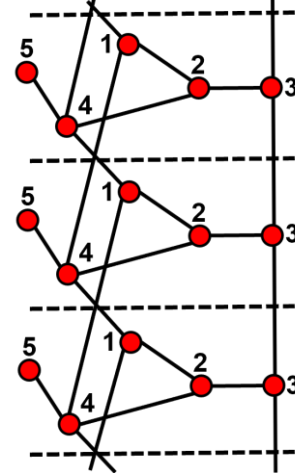

(8x1, 1x2, 2x2<sup>2</sup>) c-2

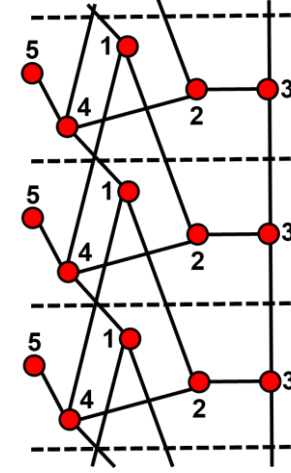

(8x1, 1x2, 2x2<sup>2</sup>) c-3

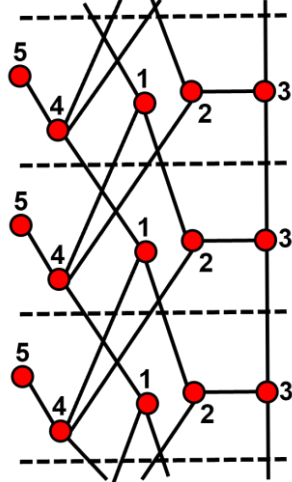

(8x1, 1x2, 2x2<sup>2</sup>) d-1

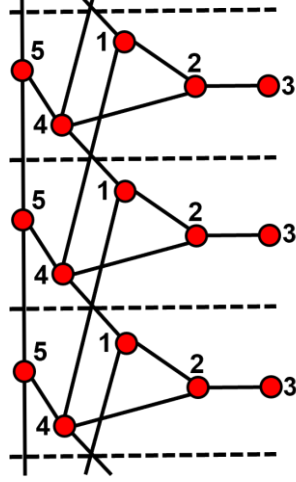

(8x1, 1x2, 2x2<sup>2</sup>) d-2

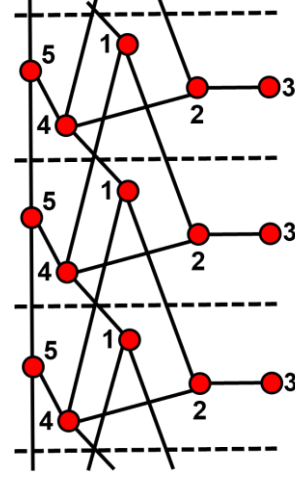

(8x1, 1x2, 2x2<sup>2</sup>) d-3

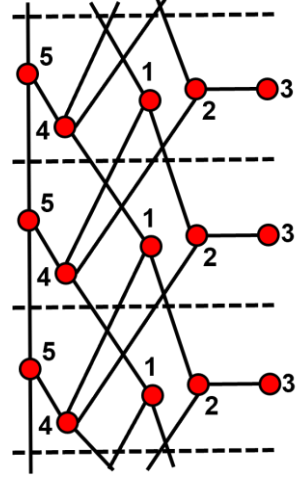

(8x1, 1x2, 2x2<sup>2</sup>) e-1

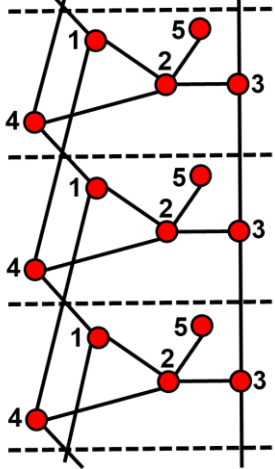

(8x1, 1x2, 2x2<sup>2</sup>) e-2

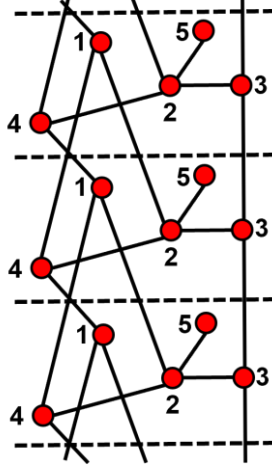

(8x1, 1x2, 2x2<sup>2</sup>) e-3

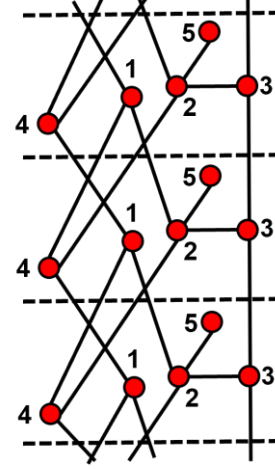

(6x1, 4x2) a

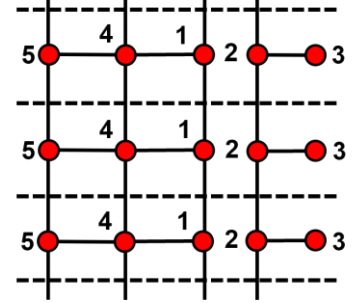

	<p>(6x1, 4x2) b</p>	<p>(6x1, 2x2, 2x2<sup>1</sup>) a</p>	<p>(6x1, 2x2, 2x2<sup>1</sup>) b</p>	<p>(6x1, 2x2, 2x2<sup>1</sup>) c</p>
	<p>(6x1, 2x2, 2x2<sup>1</sup>) d</p>	<p>(6x1, 2x2, 2x2<sup>1</sup>) e</p>	<p>(6x1, 2x2, 2x2<sup>1</sup>) f</p>	<p>(6x1, 2x2, 2x2<sup>2</sup>) a</p>
	<p>(6x1, 2x2, 2x2<sup>2</sup>) b</p>	<p>(6x1, 2x2, 2x2<sup>2</sup>) c</p>	<p>(6x1, 2x2, 2x2<sup>2</sup>) d</p>	<p>(6x1, 2x2, 2x2<sup>2</sup>) e</p>



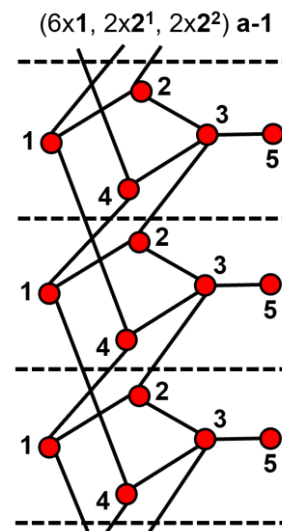
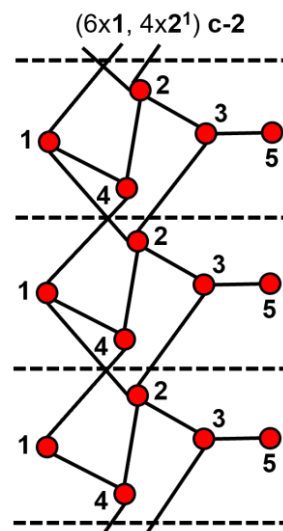
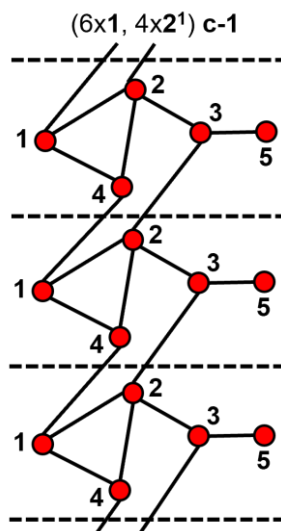
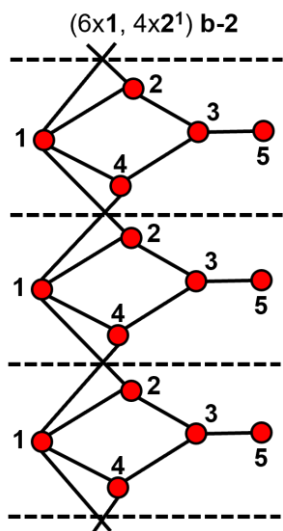
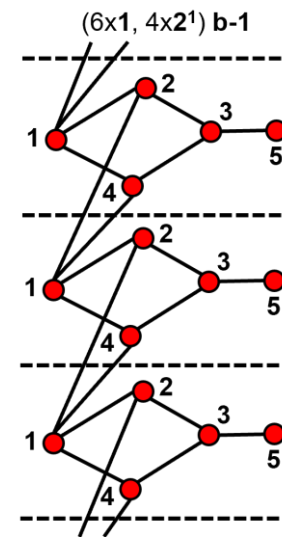
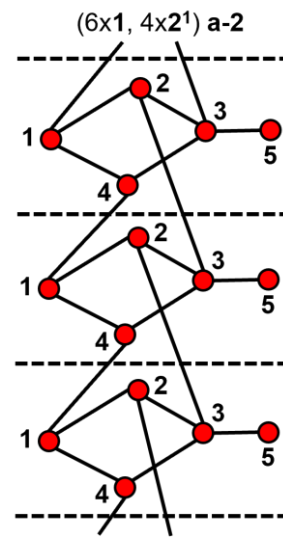
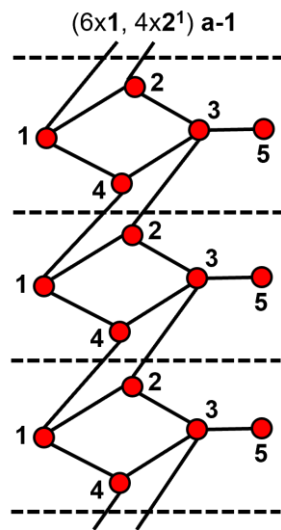
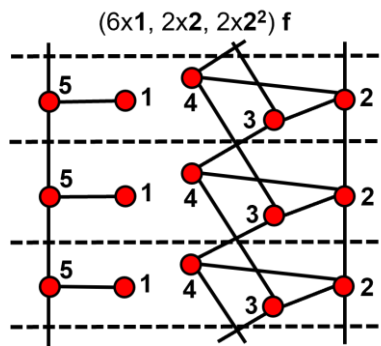

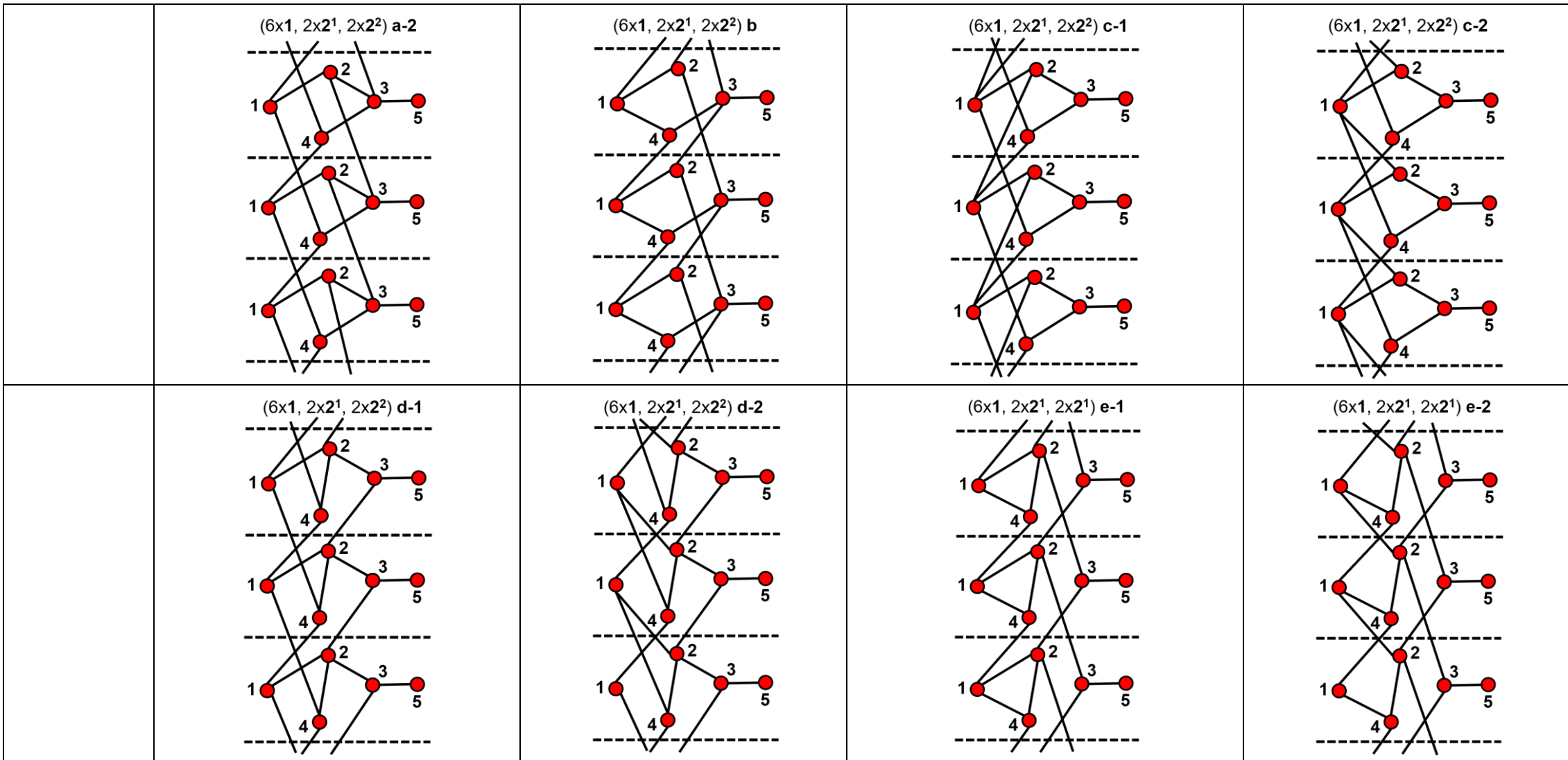

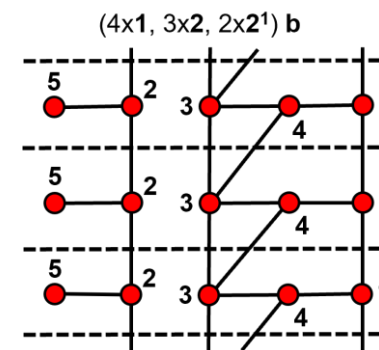
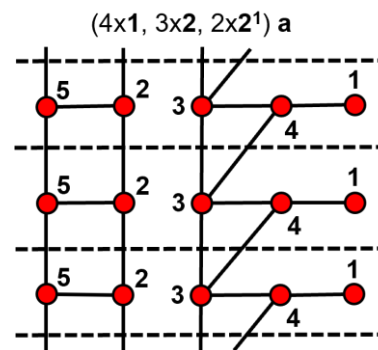
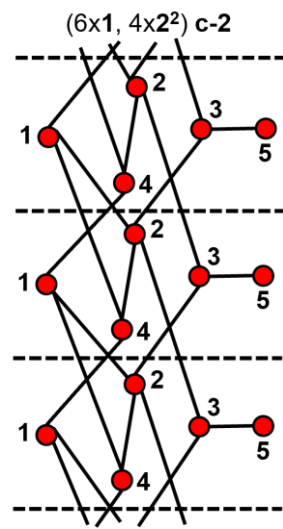
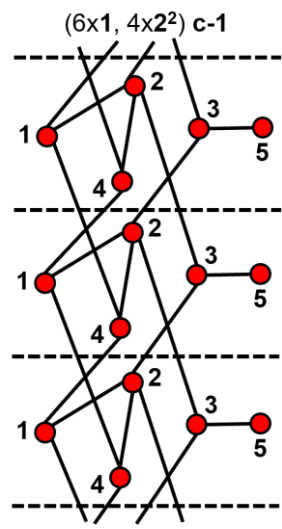
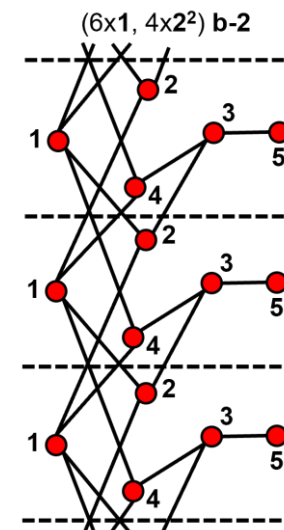
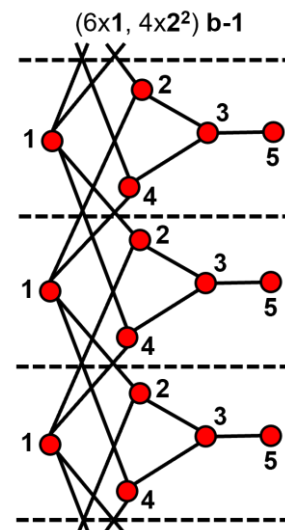
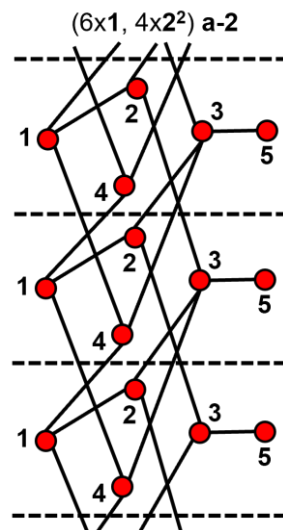
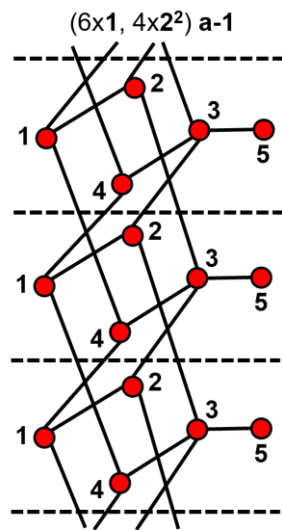

	<p>(4x1, 3x2, 2x2<sup>2</sup>) a</p>	<p>(4x1, 3x2, 2x2<sup>2</sup>) b</p>	<p>(4x1, 1x2, 4x2<sup>1</sup>) a</p>	<p>(4x1, 1x2, 4x2<sup>1</sup>) b</p>
	<p>(4x1, 1x2, 4x2<sup>1</sup>) c</p>	<p>(4x1, 1x2, 2x2<sup>1</sup>, 2x2<sup>2</sup>) a</p>	<p>(4x1, 1x2, 2x2<sup>1</sup>, 2x2<sup>2</sup>) b</p>	<p>(4x1, 1x2, 2x2<sup>1</sup>, 2x2<sup>2</sup>) c</p>
	<p>(4x1, 1x2, 2x2<sup>1</sup>, 2x2<sup>2</sup>) d</p>	<p>(4x1, 1x2, 2x2<sup>1</sup>, 2x2<sup>2</sup>) e</p>	<p>(4x1, 1x2, 4x2<sup>2</sup>) a</p>	<p>(4x1, 1x2, 4x2<sup>2</sup>) b</p>

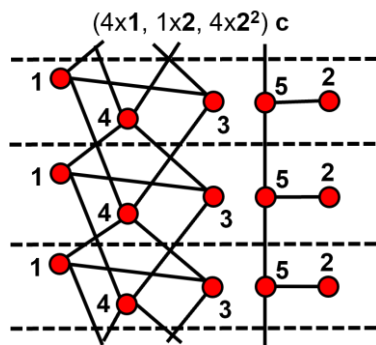

${}^1V_1{}^3V_3{}^4V_2$

NG

${}^1V_1{}^3V_3{}^4V_3$

NG

${}^1V_1{}^3V_3{}^4V_4$

NG

${}^1V_1{}^3V_5{}^4V_1$

NG

${}^1V_1{}^3V_5{}^4V_2$

NG

${}^1V_2{}^3V_2{}^4V_1$

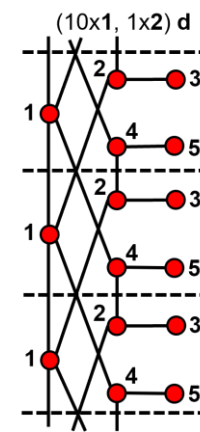
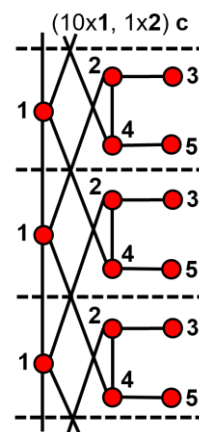
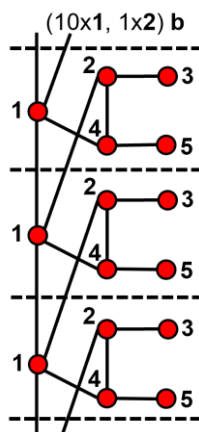
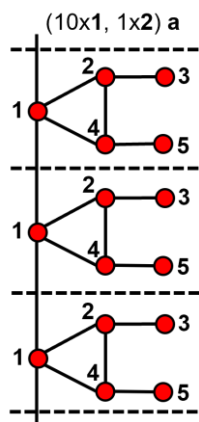

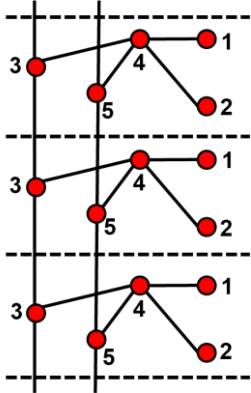
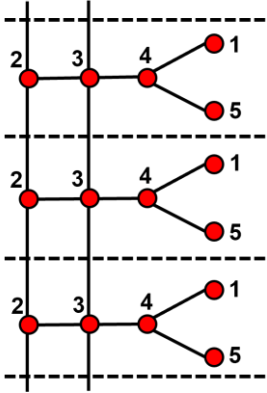
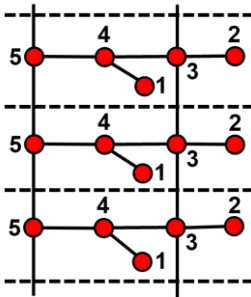
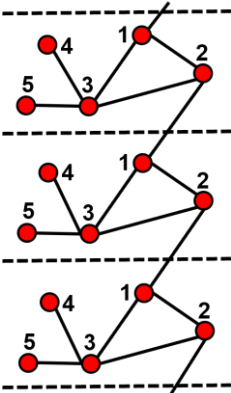
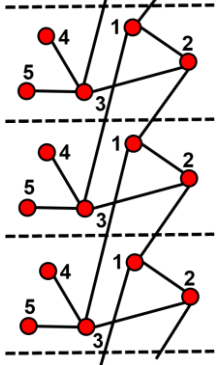
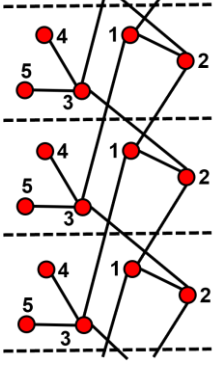
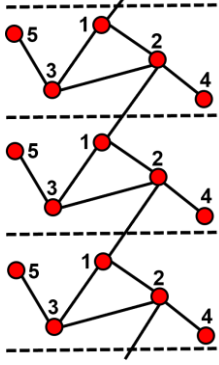
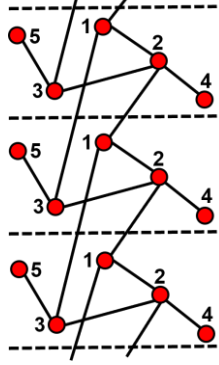
	<p>(8x1, 2x2) a</p> 	<p>(8x1, 2x2) b</p> 	<p>(8x1, 2x2) c</p> 	<p>(8x1, 2x2¹) a-1</p> 
	<p>(8x1, 2x2¹) a-2</p> 	<p>(8x1, 2x2¹) a-3</p> 	<p>(8x1, 2x2¹) b-1</p> 	<p>(8x1, 2x2¹) b-2</p> 

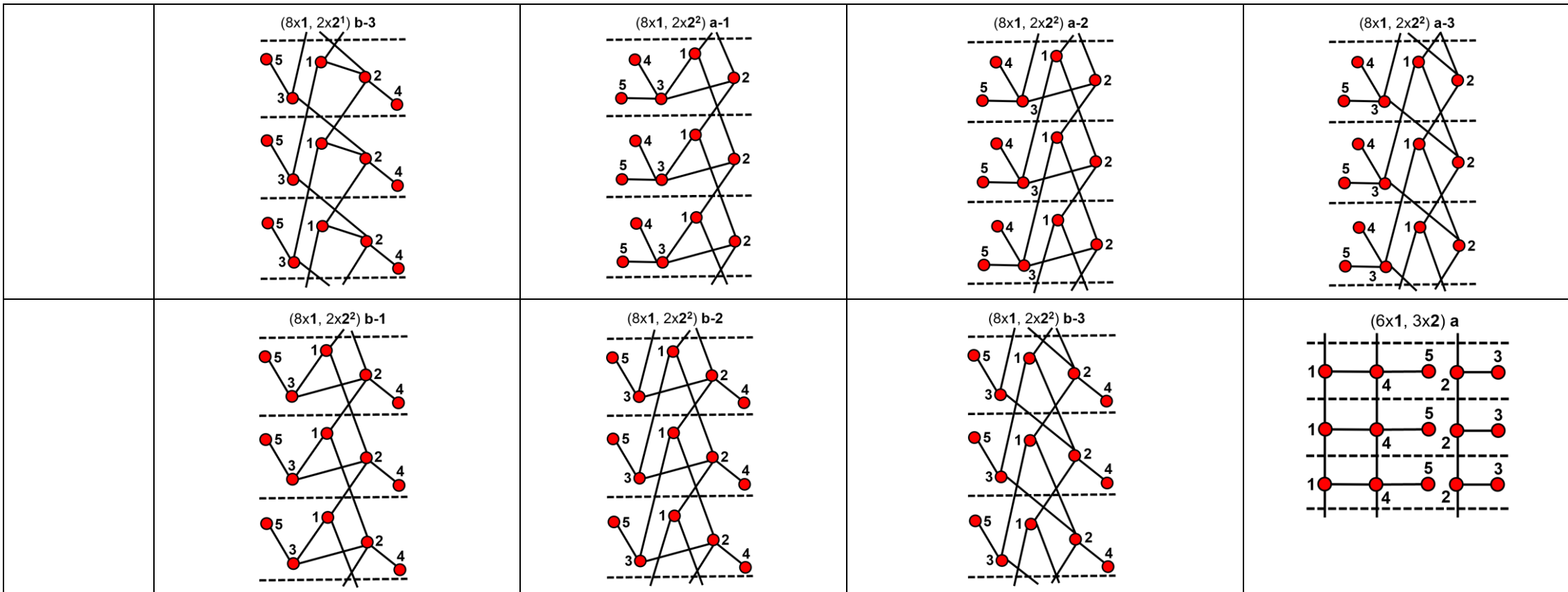

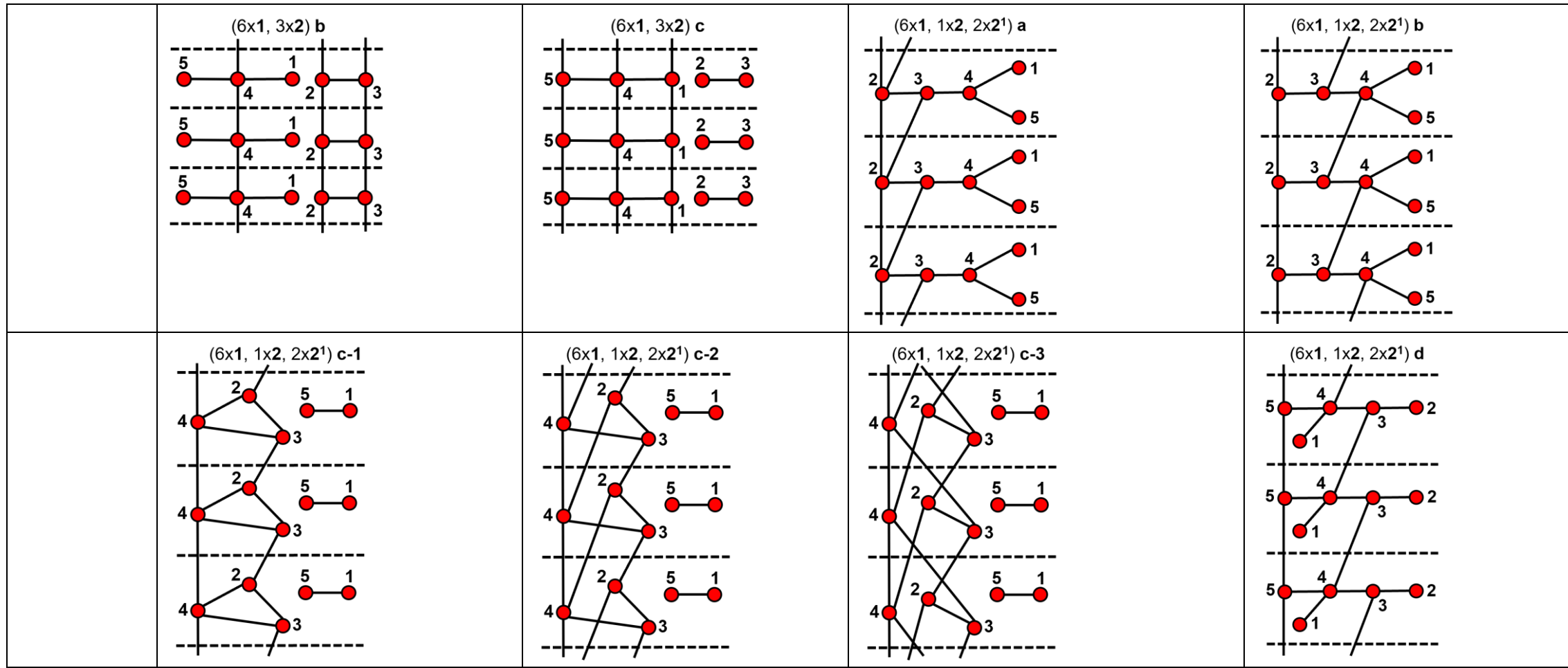



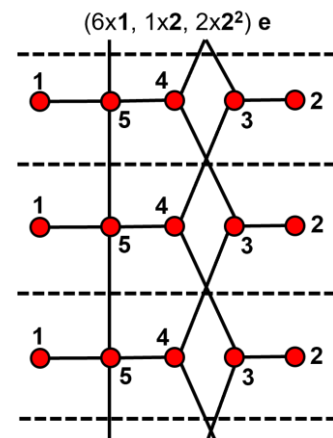
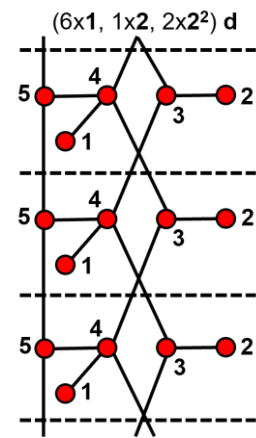
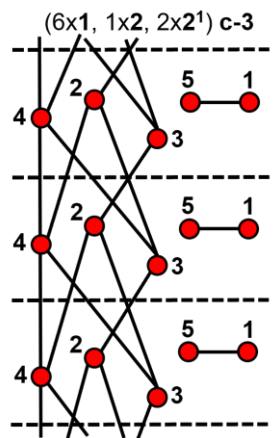
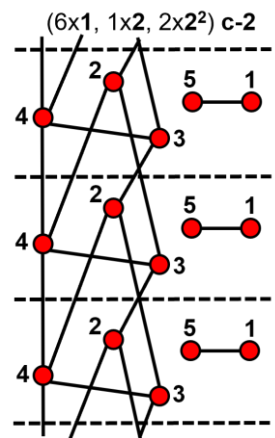
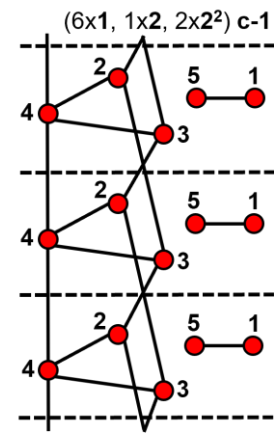
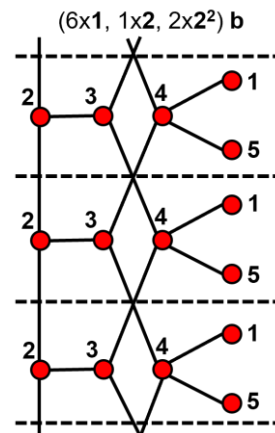
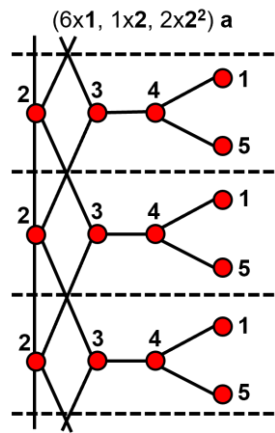
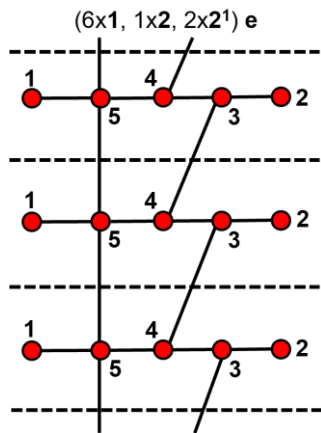

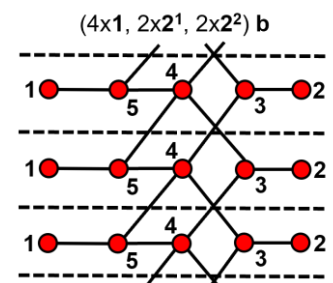
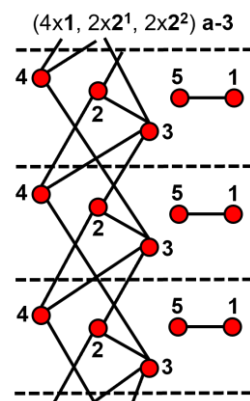
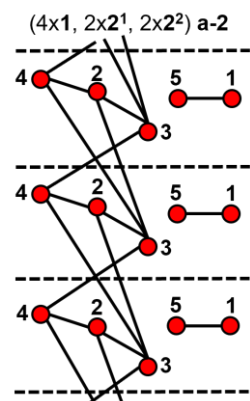
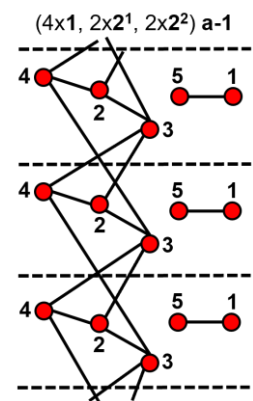
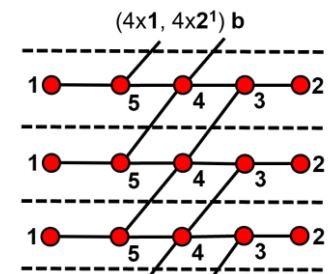
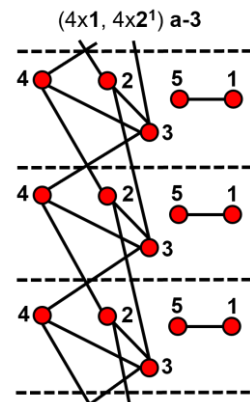
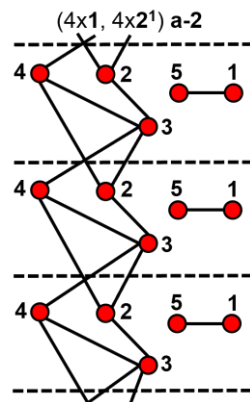
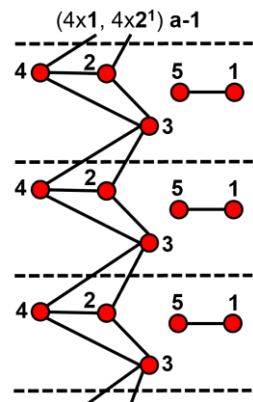
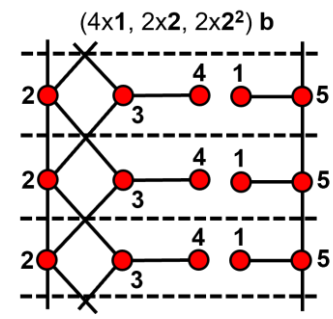
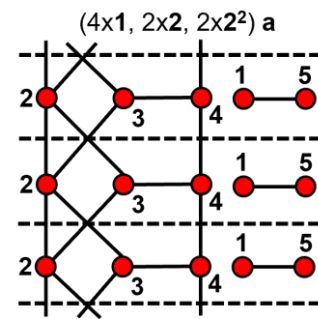
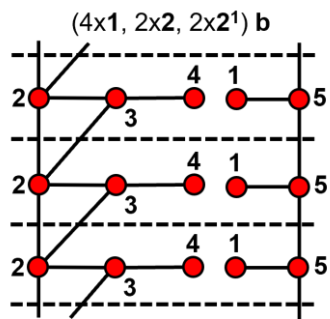
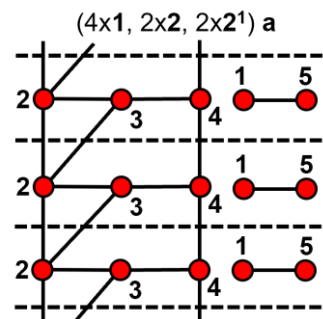

	<p>(4x1, 4x2<sup>2</sup>) a-1</p>	<p>(4x1, 4x2<sup>2</sup>) a-2</p>	<p>(4x1, 4x2<sup>2</sup>) b</p>	
${}^1V_2{}^3V_2{}^4V_2$	NG			
${}^1V_2{}^3V_2{}^4V_3$	NG			
${}^1V_2{}^3V_2{}^4V_4$	NG			
${}^1V_2{}^3V_4{}^4V_1$	NG			
${}^1V_2{}^3V_4{}^4V_2$	NG			
${}^1V_3{}^3V_1{}^4V_1$	<p>(8x1, 1x2) a</p>	<p>(8x1, 1x2) b</p>	<p>(6x1, 2x2) a</p>	<p>(6x1, 2x2) b</p>

	<p>(6x1, 2x2<sup>1</sup>)</p>	<p>(6x1, 2x2<sup>2</sup>)</p>	<p>(4x1, 1x2, 2x2<sup>1</sup>)</p>	<p>(4x1, 1x2, 2x2<sup>2</sup>)</p>
${}^1V_3{}^3V_1{}^4V_2$	NG			
${}^1V_3{}^3V_1{}^4V_3$	NG			
${}^1V_3{}^3V_1{}^4V_4$	NG			
${}^1V_3{}^3V_3{}^4V_1$	NG			
${}^1V_3{}^3V_3{}^4V_2$	NG			
${}^1V_4{}^3V_2{}^4V_1$	NG			
${}^1V_4{}^3V_2{}^4V_2$	NG			
${}^1V_5{}^3V_1{}^4V_1$	NG			
${}^1V_5{}^3V_1{}^4V_2$	NG			
${}^2V_r{}^3V_r{}^4V_r$				

${}^2V_1{}^3V_2{}^4V_1$

(10x1, 1x2) a

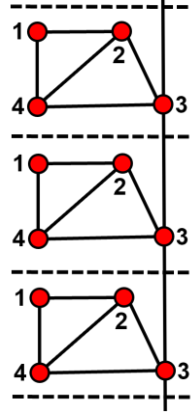

(10x1, 1x2) b

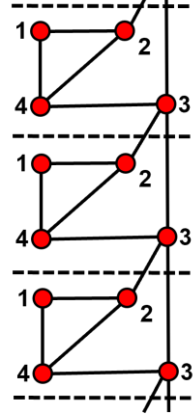

(10x1, 1x2) c

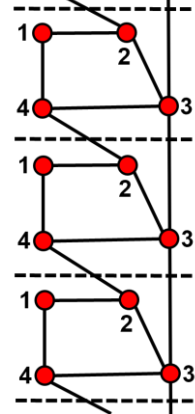

(10x1, 1x2) d

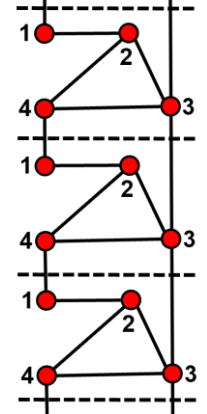

(10x1, 1x2) e

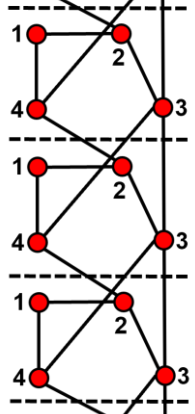

(10x1, 1x2) f

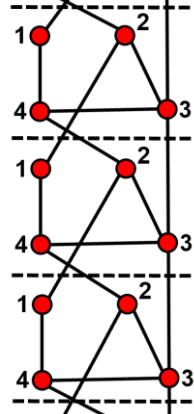

(10x1, 1x2) g

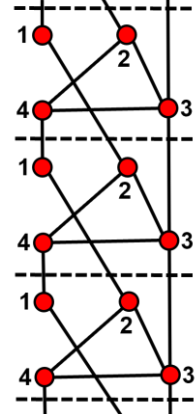

(10x1, 1x2) h

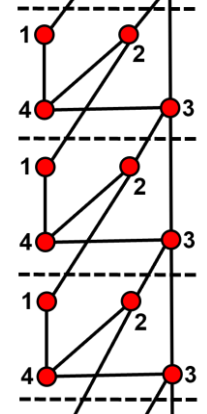

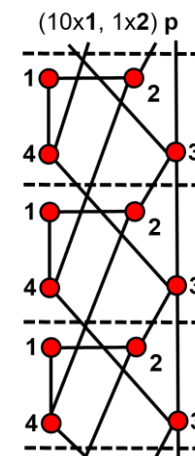
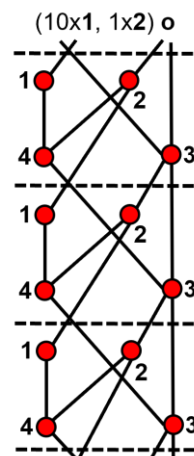
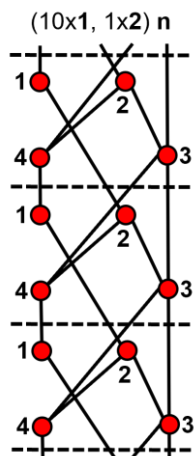
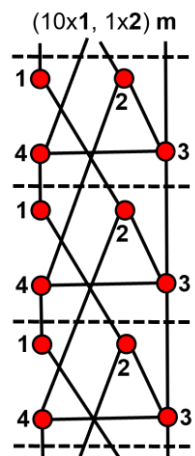
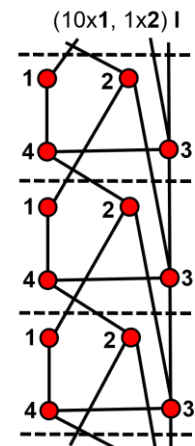
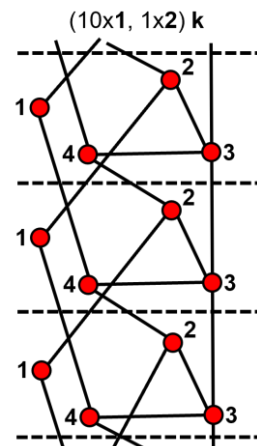
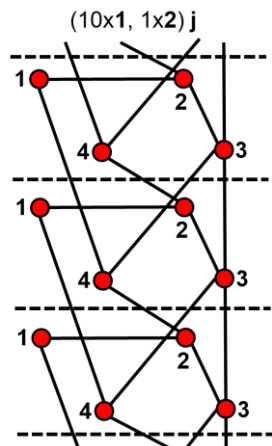
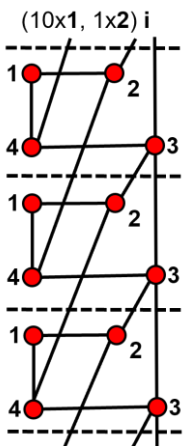

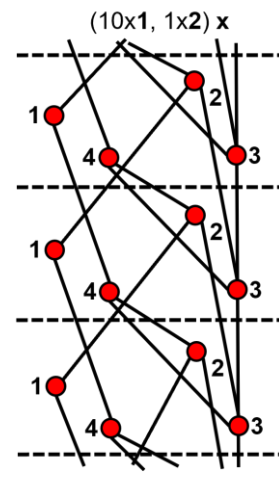
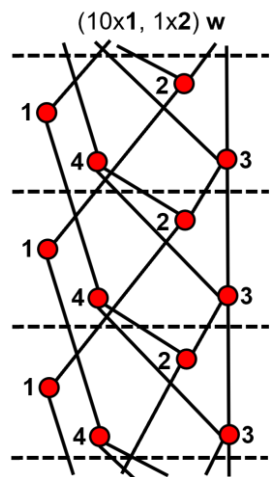
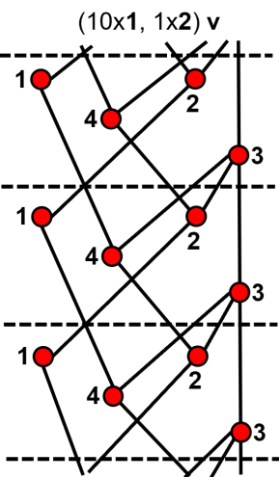
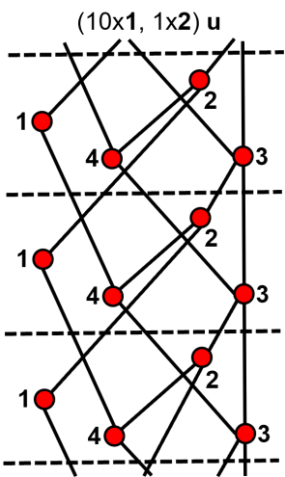
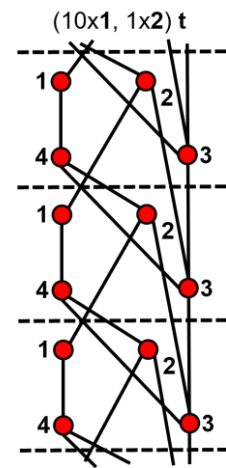
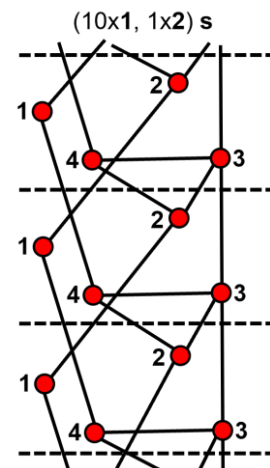
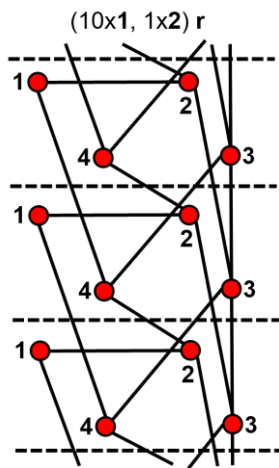
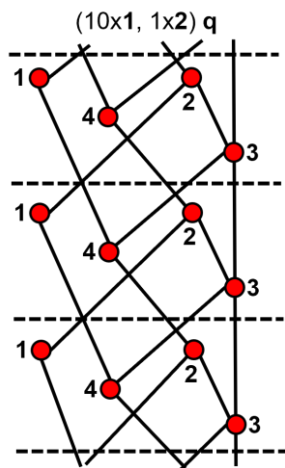

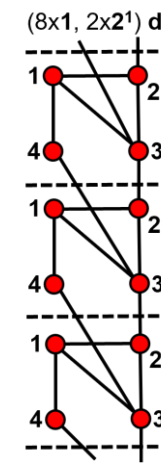
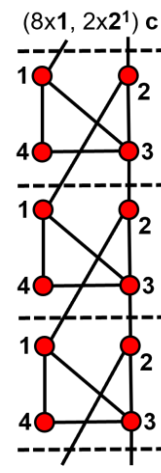
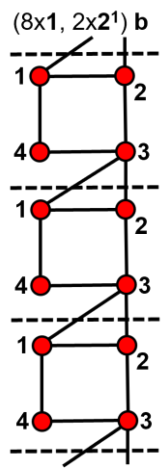
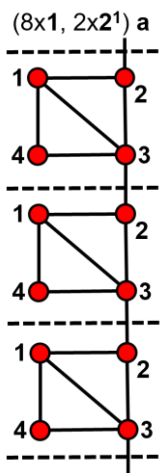
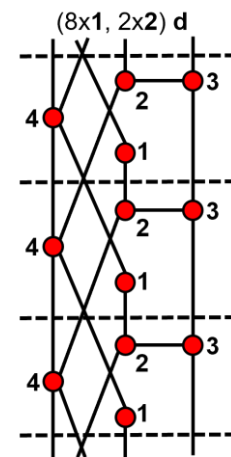
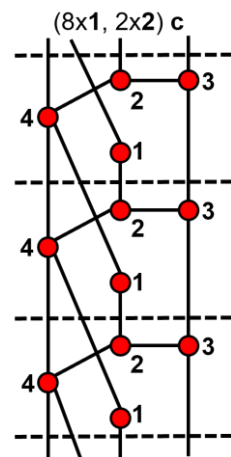
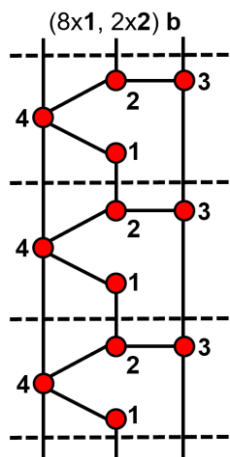
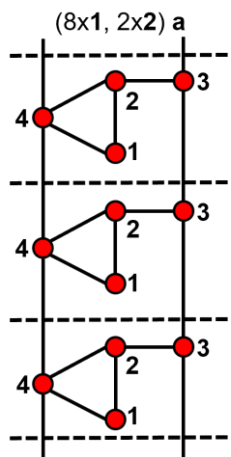



(8x1, 2x2<sup>1</sup>) e

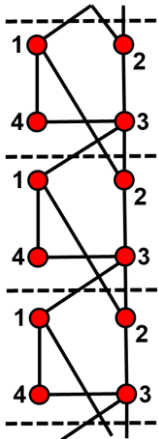

(8x1, 2x2<sup>1</sup>) f

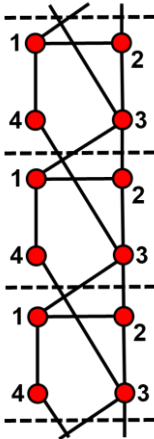

(8x1, 2x2<sup>1</sup>) g

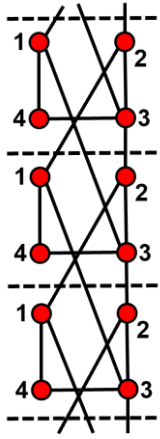

(8x1, 2x2<sup>1</sup>) h

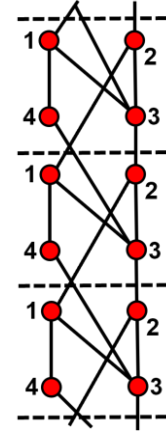

(8x1, 2x2<sup>1</sup>) i

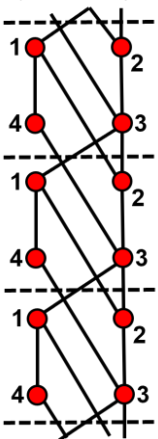

(8x1, 2x2<sup>1</sup>) j

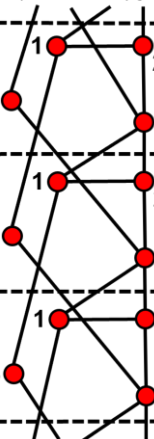

(8x1, 2x2<sup>1</sup>) k

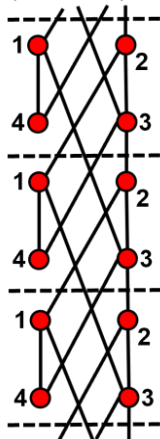

(8x1, 2x2<sup>1</sup>) l

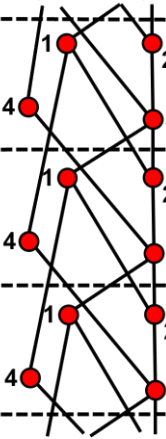

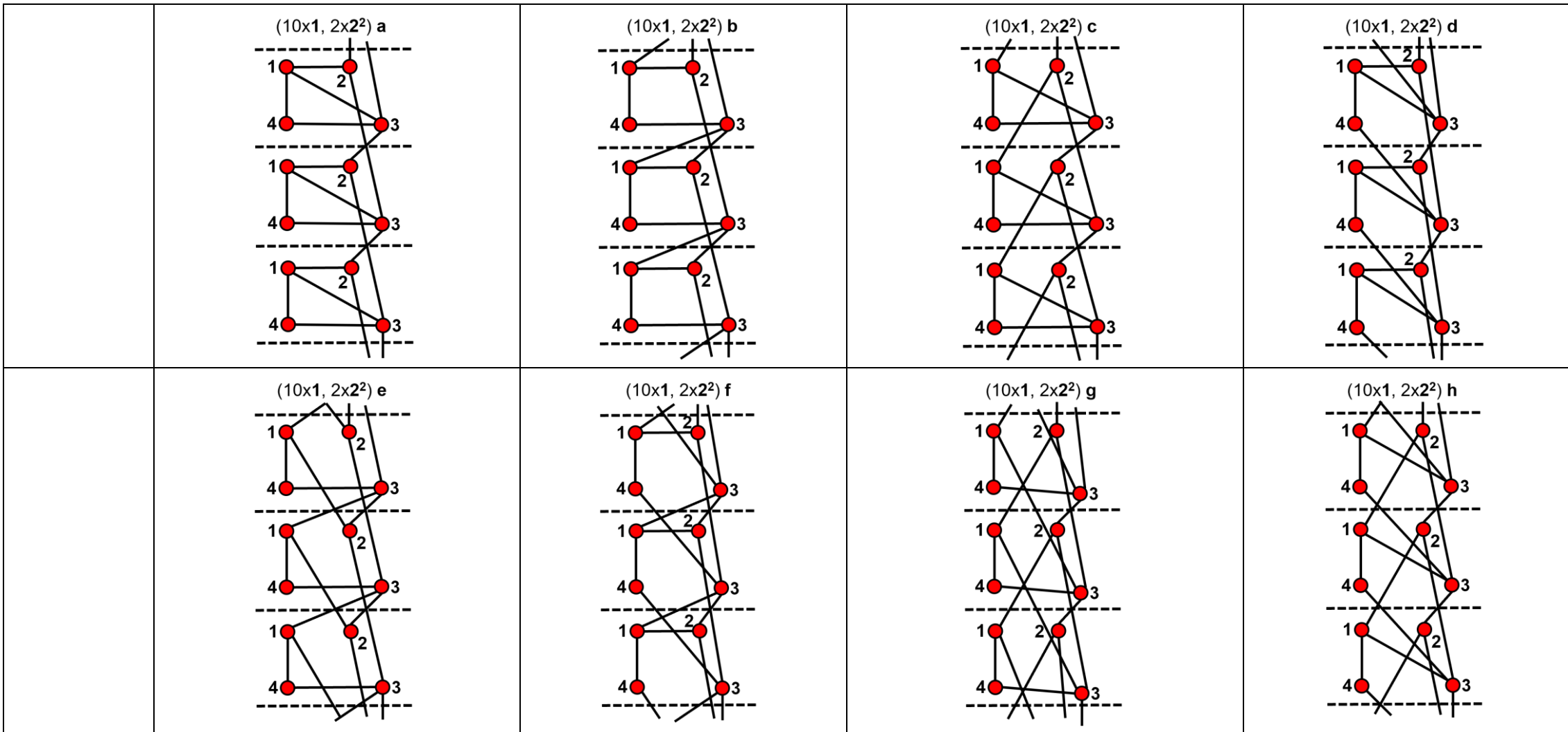

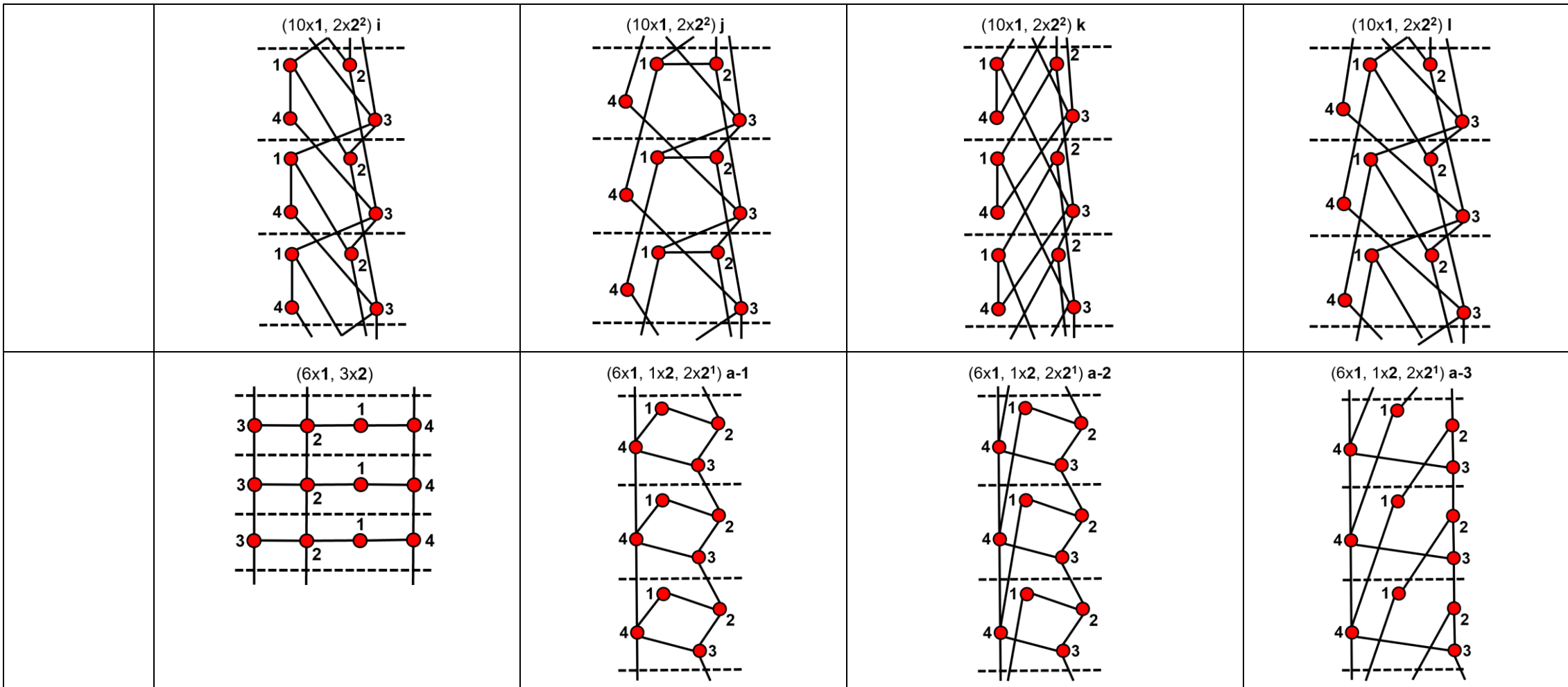

(6x1, 1x2, 2x2<sup>1</sup>) a-4

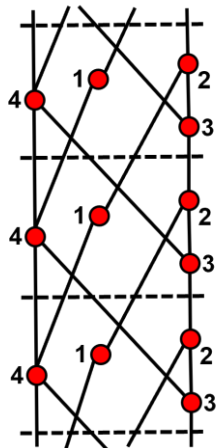

(6x1, 1x2, 2x2<sup>1</sup>) b-1

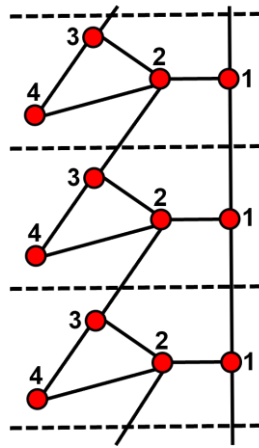

(6x1, 1x2, 2x2<sup>1</sup>) b-2

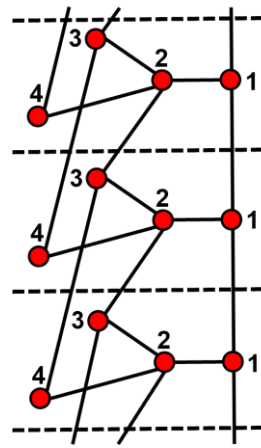

(6x1, 1x2, 2x2<sup>1</sup>) b-3

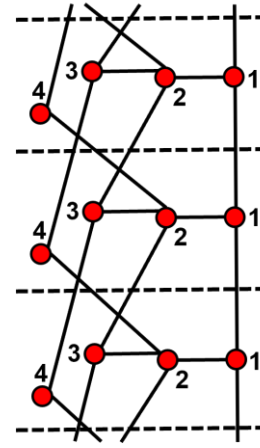

(6x1, 1x2, 2x2<sup>2</sup>) a-1

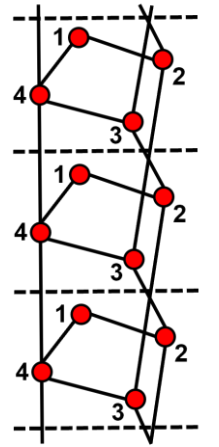

(6x1, 1x2, 2x2<sup>2</sup>) a-2

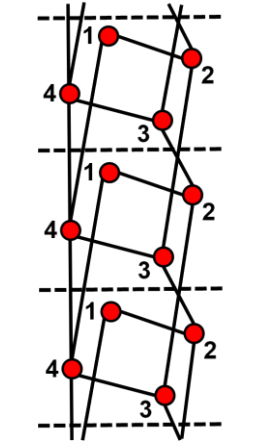

(6x1, 1x2, 2x2<sup>2</sup>) a-3

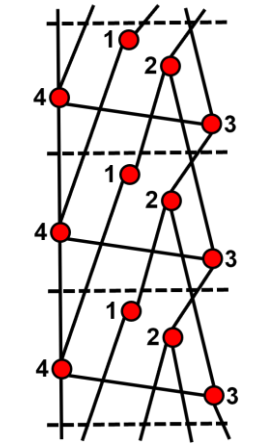

(6x1, 1x2, 2x2<sup>2</sup>) a-4

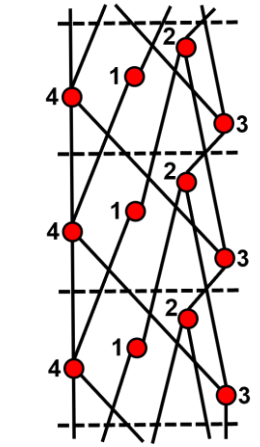

(6x1, 1x2, 2x2<sup>2</sup>) b-1

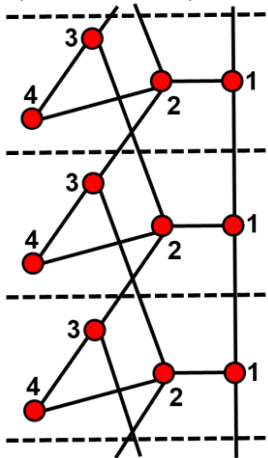

(6x1, 1x2, 2x2<sup>2</sup>) b-2

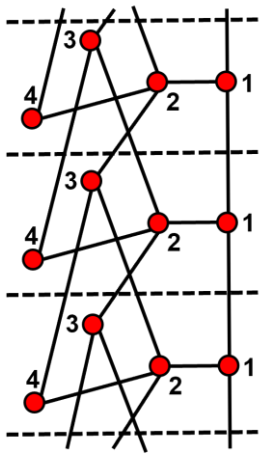

(6x1, 1x2, 2x2<sup>2</sup>) b-3

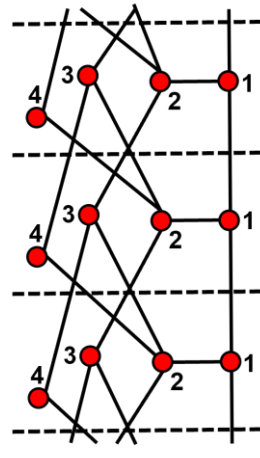

(4x1, 4x2)

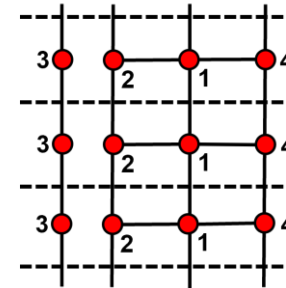

(4x1, 2x2, 2x2<sup>1</sup>) a

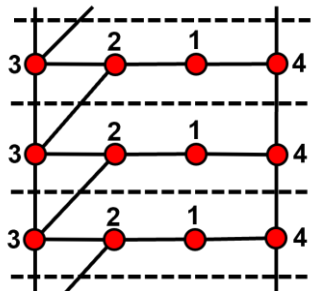

(4x1, 2x2, 2x2<sup>1</sup>) b

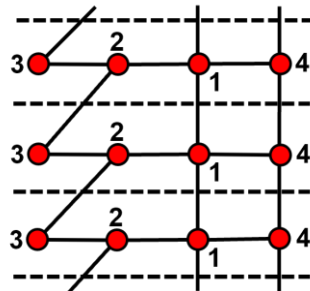

(4x1, 2x2, 2x2<sup>1</sup>) c

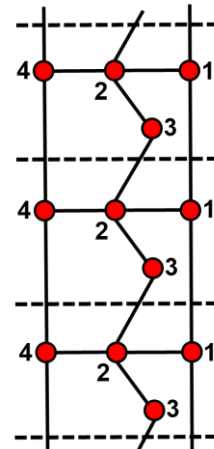

(4x1, 2x2, 2x2<sup>1</sup>) d-1

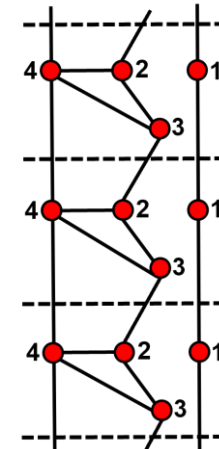

(4x1, 2x2, 2x2<sup>1</sup>) d-2

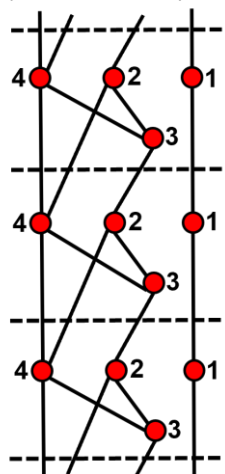

(4x1, 2x2, 2x2<sup>1</sup>) d-3

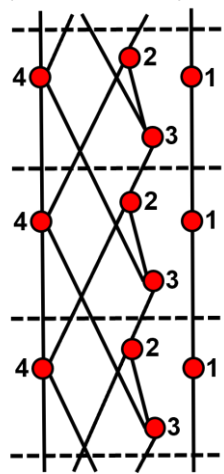

(4x1, 2x2, 2x2<sup>2</sup>) a

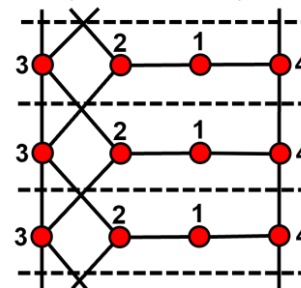

(4x1, 2x2, 2x2<sup>2</sup>) b

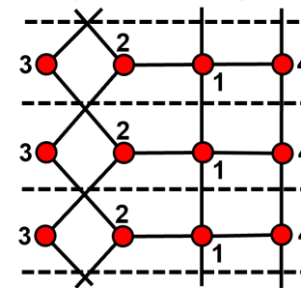

(4x1, 2x2, 2x2<sup>2</sup>) c

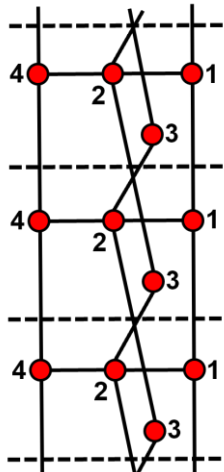

(4x1, 2x2, 2x2<sup>2</sup>) d-1

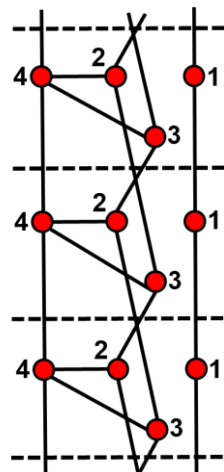

(4x1, 2x2, 2x2<sup>2</sup>) d-2

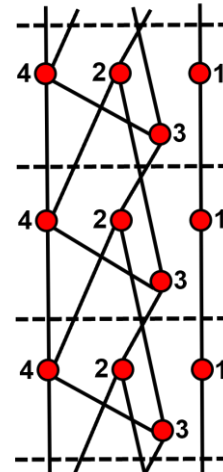

(4x1, 2x2, 2x2<sup>2</sup>) d-3

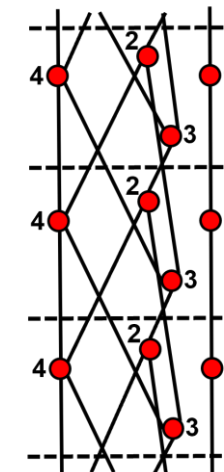

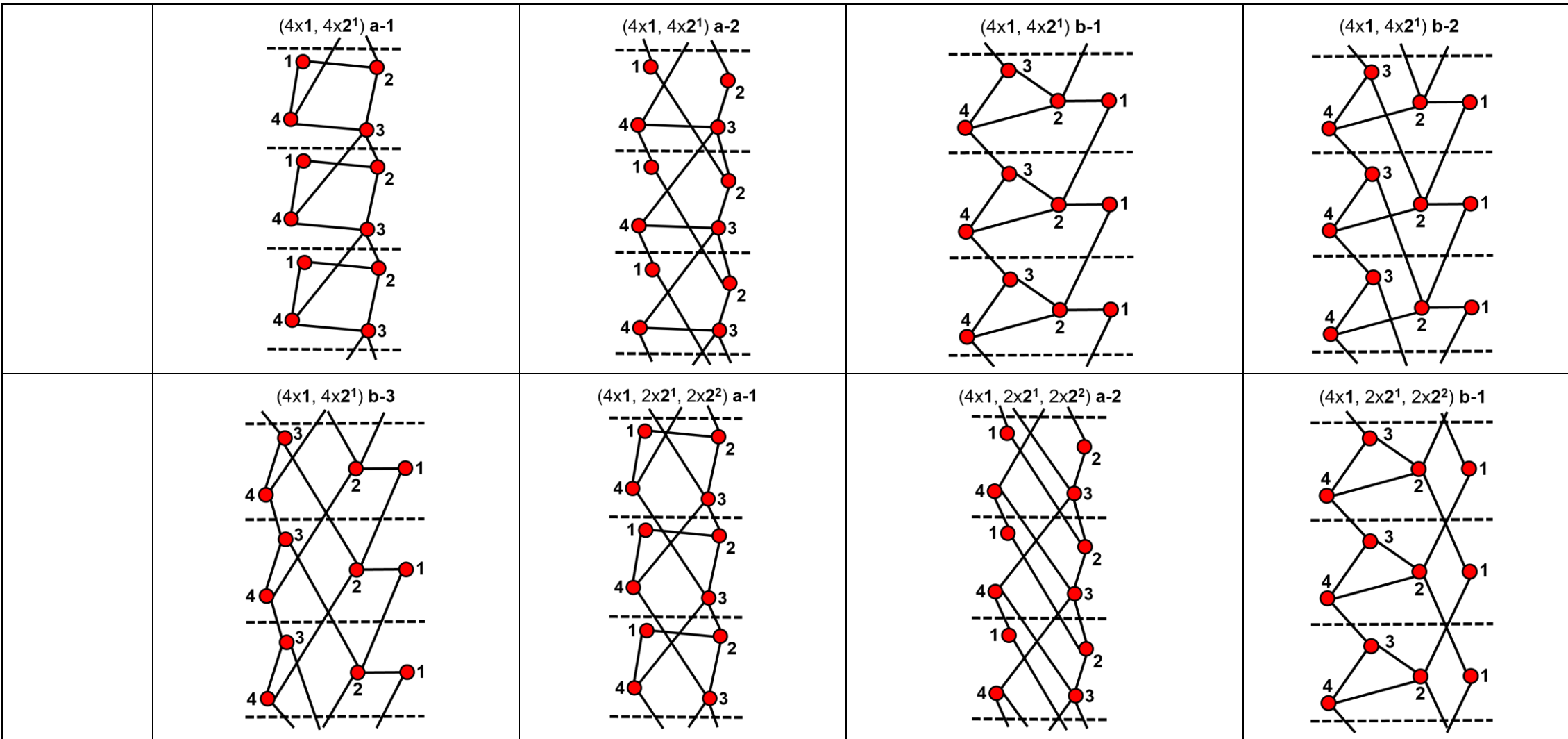

(4x1, 2x2<sup>1</sup>, 2x2<sup>2</sup>) b-2

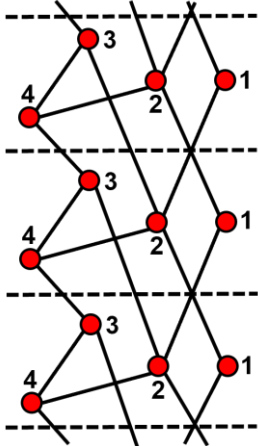

(4x1, 2x2<sup>1</sup>, 2x2<sup>2</sup>) b-3

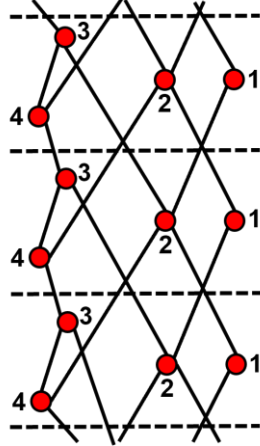

(4x1, 2x2<sup>1</sup>, 2x2<sup>2</sup>) c-1

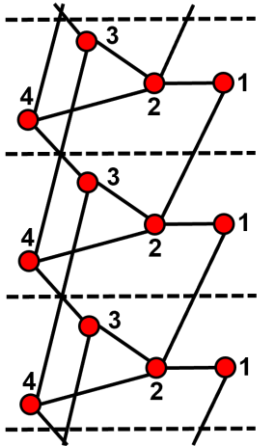

(4x1, 2x2<sup>1</sup>, 2x2<sup>2</sup>) c-2

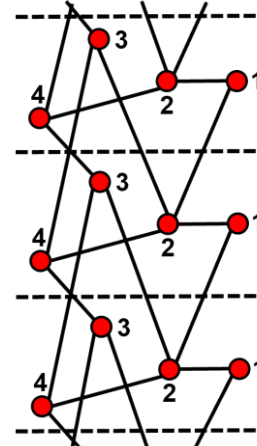

(4x1, 2x2<sup>1</sup>, 2x2<sup>2</sup>) c-3

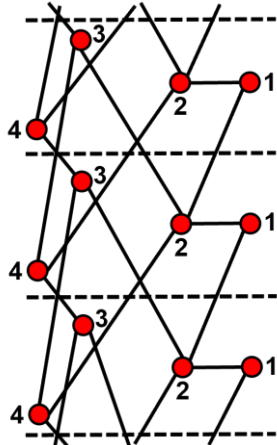

(4x1, 4x2<sup>2</sup>) a-1

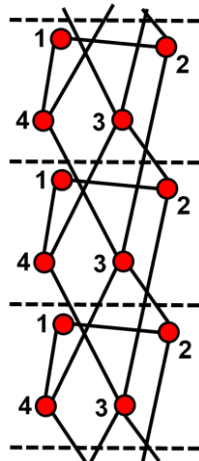

(4x1, 4x2<sup>2</sup>) a-2

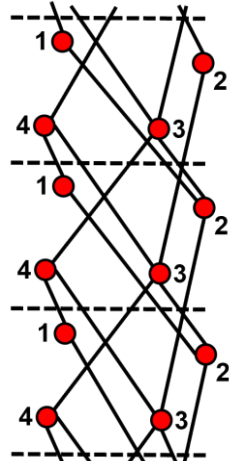

(4x1, 4x2<sup>2</sup>) b-1

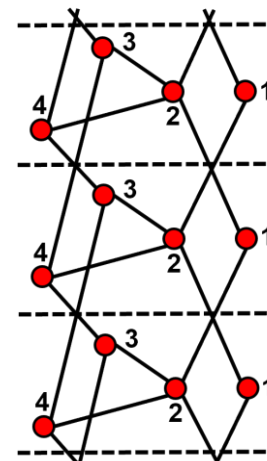



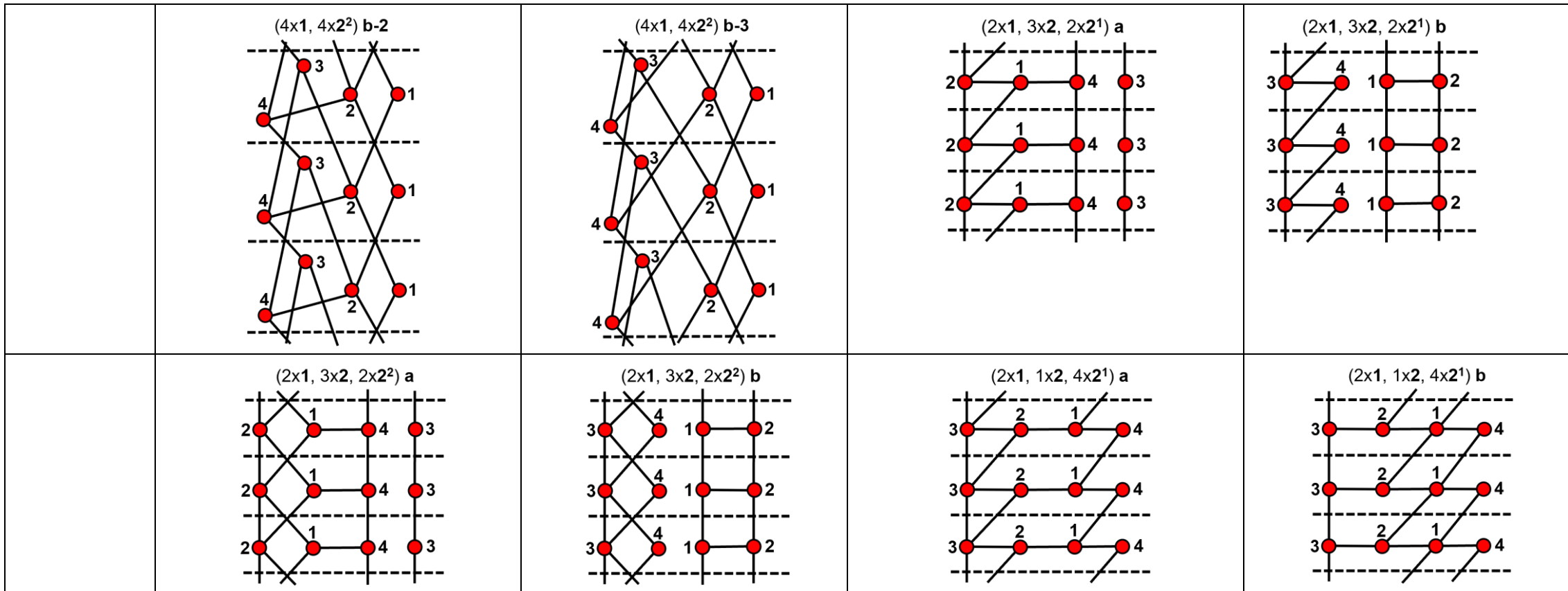

	<p>(2x1, 1x2, 4x2<sup>1</sup>) c-1</p>	<p>(2x1, 1x2, 4x2<sup>1</sup>) c-2</p>	<p>(2x1, 1x2, 2x2<sup>1</sup>, 2x2<sup>2</sup>) a</p>	<p>(2x1, 1x2, 2x2<sup>1</sup>, 2x2<sup>2</sup>) b</p>
	<p>(2x1, 1x2, 2x2<sup>1</sup>, 2x2<sup>2</sup>) c</p>	<p>(2x1, 1x2, 2x2<sup>1</sup>, 2x2<sup>2</sup>) d</p>	<p>(2x1, 1x2, 2x2<sup>1</sup>, 2x2<sup>2</sup>) e-1</p>	<p>(2x1, 1x2, 2x2<sup>1</sup>, 2x2<sup>2</sup>) e-2</p>

	(2x1, 1x2, 4x2 <sup>2</sup> ) a	(2x1, 1x2, 4x2 <sup>2</sup> ) b	(2x1, 1x2, 4x2 <sup>2</sup> ) c-1	(2x1, 1x2, 4x2 <sup>2</sup> ) c-2
${}^2V_1{}^3V_2{}^4V_2$	NG			
${}^2V_1{}^3V_2{}^4V_3$	NG			
${}^2V_1{}^3V_2{}^4V_4$	NG			
${}^2V_1{}^3V_2{}^4V_5$	NG			
${}^2V_1{}^3V_4{}^4V_1$	NG			
${}^2V_1{}^3V_4{}^4V_2$	NG			
${}^2V_1{}^3V_4{}^4V_3$	NG			
${}^2V_1{}^3V_6{}^4V_1$	NG			
${}^2V_2{}^3V_2{}^4V_1$	NG			
${}^2V_2{}^3V_2{}^4V_2$	NG			
${}^2V_2{}^3V_2{}^4V_3$	NG			
${}^2V_2{}^3V_2{}^4V_4$	NG			
${}^2V_2{}^3V_4{}^4V_1$	NG			
${}^2V_2{}^3V_4{}^4V_2$	NG			

${}^2V_3{}^3V_2{}^4V_1$	NG
${}^2V_3{}^3V_2{}^4V_2$	NG
${}^2V_3{}^3V_2{}^4V_3$	NG
${}^2V_3{}^3V_4{}^4V_1$	NG
${}^2V_4{}^3V_2{}^4V_1$	NG
${}^2V_4{}^3V_2{}^4V_2$	NG
${}^2V_5{}^3V_2{}^4V_1$	NG
<b>Rank 4</b>	
${}^1V_r{}^2V_r{}^3V_r{}^4V_r$	
${}^1V_1{}^2V_1{}^3V_1{}^4V_1$	<div style="display: flex; justify-content: space-around;"> <div style="text-align: center;"> <p>(8x1, 1x2) a</p> </div> <div style="text-align: center;"> <p>(8x1, 1x2) b</p> </div> <div style="text-align: center;"> <p>(8x1, 1x2) c</p> </div> <div style="text-align: center;"> <p>(8x1, 1x2) d</p> </div> </div>

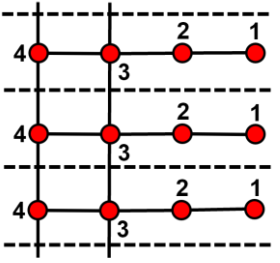
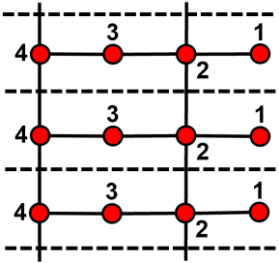
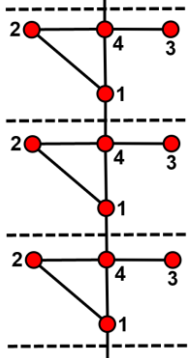
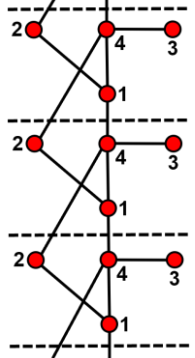
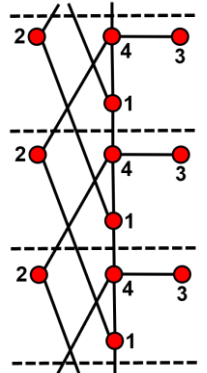
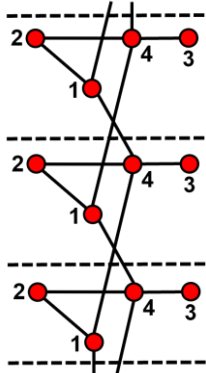
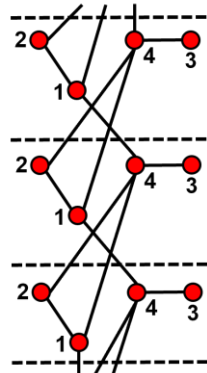
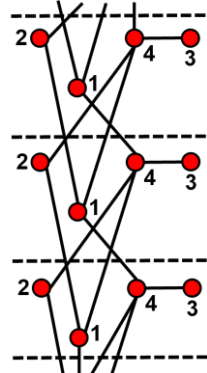
	<p>(6x1, 2x2) a</p> 	<p>(6x1, 2x2) b</p> 	<p>(6x1, 2x2<sup>1</sup>) a</p> 	<p>(6x1, 2x2<sup>1</sup>) b</p> 
	<p>(6x1, 2x2<sup>1</sup>) c</p> 	<p>(6x1, 2x2<sup>2</sup>) a</p> 	<p>(6x1, 2x2<sup>2</sup>) b</p> 	<p>(6x1, 2x2<sup>2</sup>) c</p> 

	<p>(4x1, 3x2)</p>	<p>(4x1, 1x2, 2x2<sup>1</sup>) a</p>	<p>(4x1, 1x2, 2x2<sup>1</sup>) b</p>	<p>(4x1, 1x2, 2x2<sup>1</sup>) c</p>
	<p>(4x1, 1x2, 2x2<sup>2</sup>) a</p>	<p>(4x1, 1x2, 2x2<sup>2</sup>) b</p>	<p>(4x1, 1x2, 2x2<sup>2</sup>) c</p>	<p>(2x1, 2x2, 2x2<sup>1</sup>) a</p>
	<p>(2x1, 2x2, 2x2<sup>1</sup>) b</p>	<p>(2x1, 2x2, 2x2<sup>2</sup>) a</p>	<p>(2x1, 2x2, 2x2<sup>2</sup>) b</p>	<p>(2x1, 4x2<sup>1</sup>)</p>

	<p>(2x1, 2x2<sup>1</sup>, 2x2<sup>2</sup>) a</p>	<p>(2x1, 2x2<sup>1</sup>, 2x2<sup>2</sup>) b</p>	<p>(2x1, 4x2<sup>2</sup>)</p>	
${}^1V_1{}^2V_1{}^3V_1{}^4V_2$	<p>(12x1, 1x2) a</p>	<p>(12x1, 1x2) b</p>	<p>(12x1, 1x2) c</p>	<p>(12x1, 1x2) d</p>





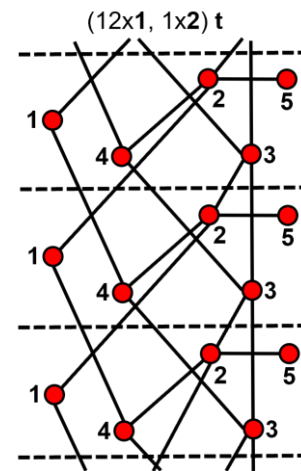
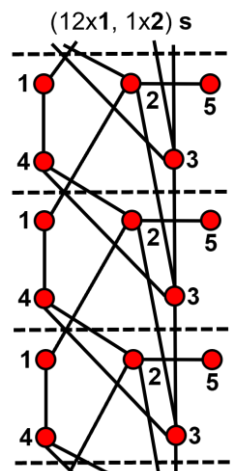
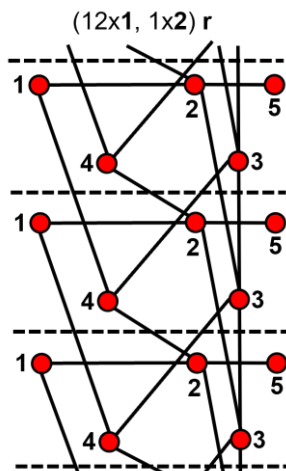
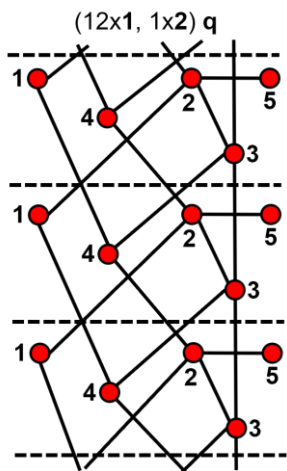
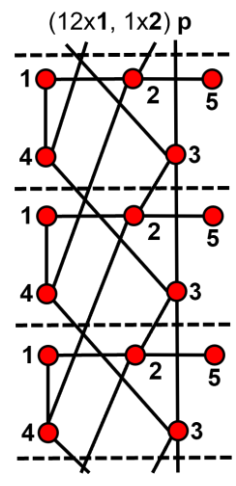
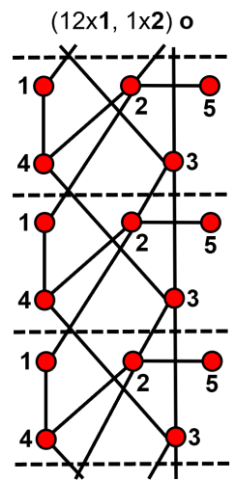
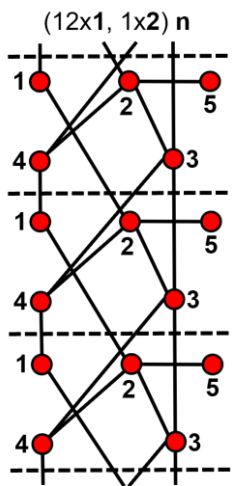
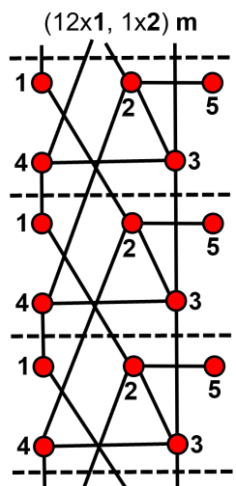

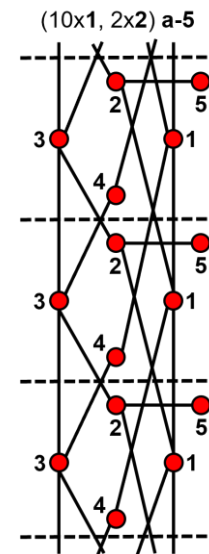
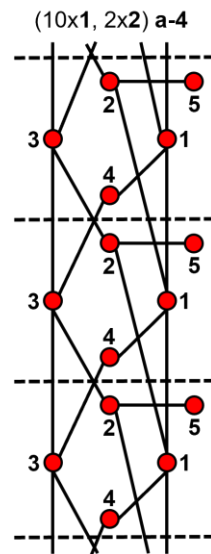
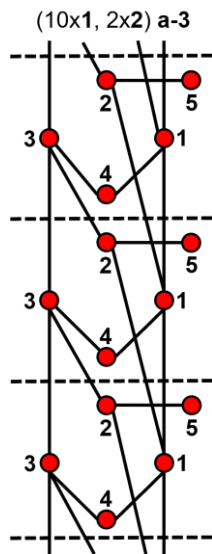
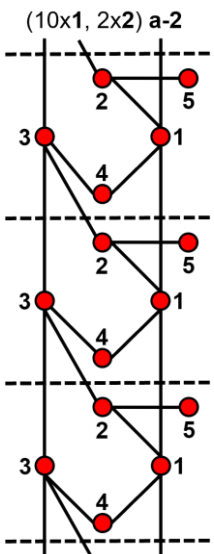
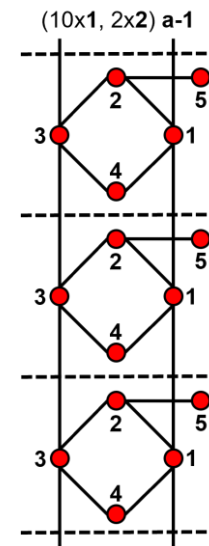
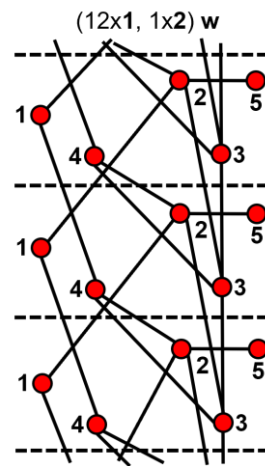
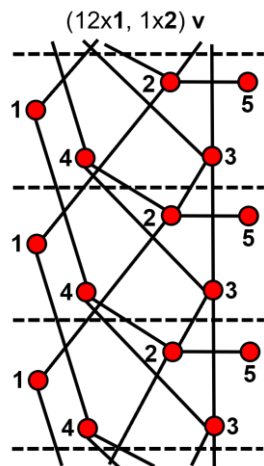
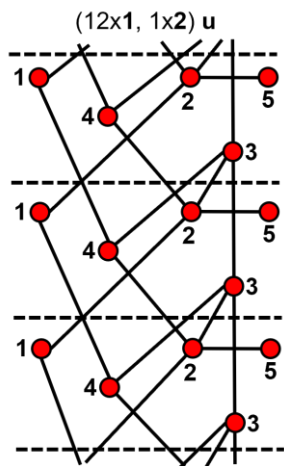

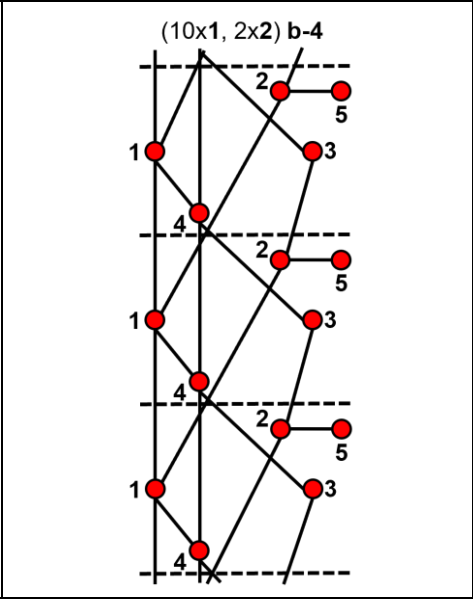
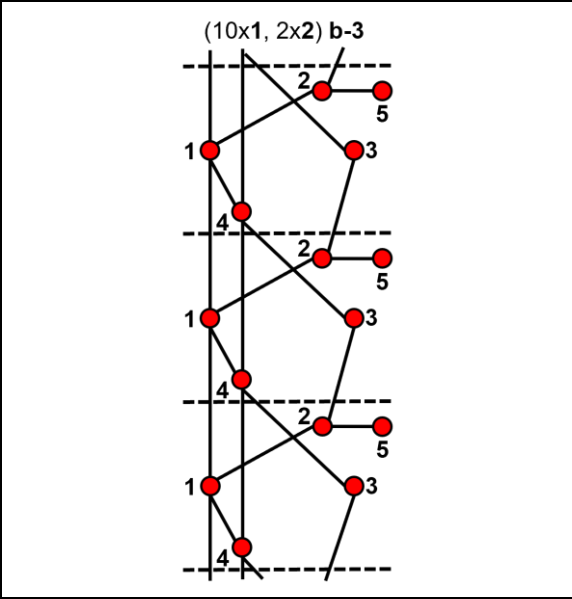
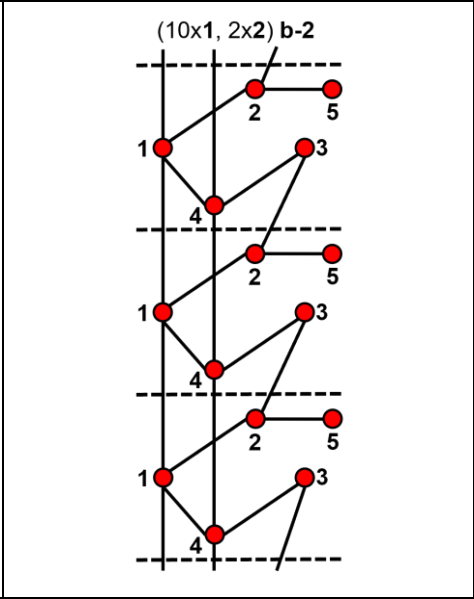
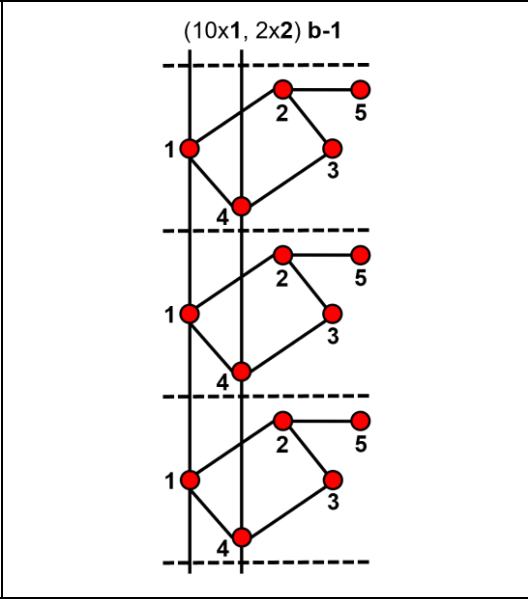
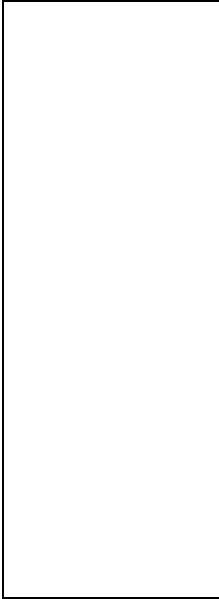

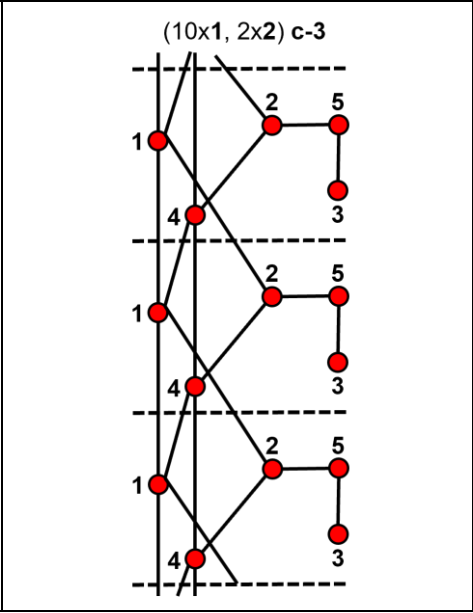
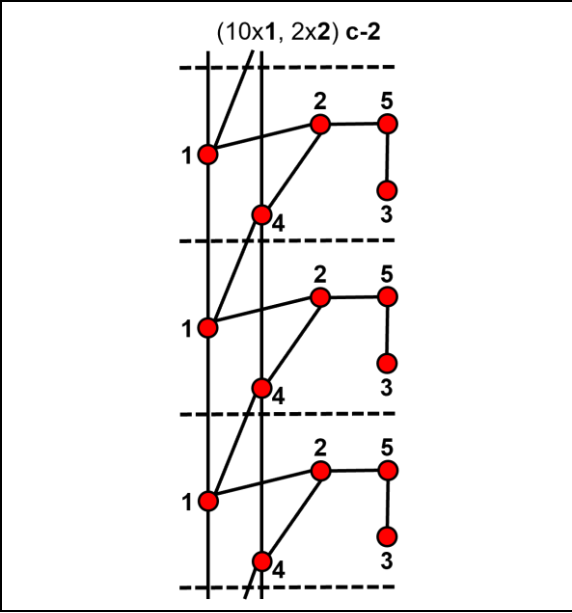
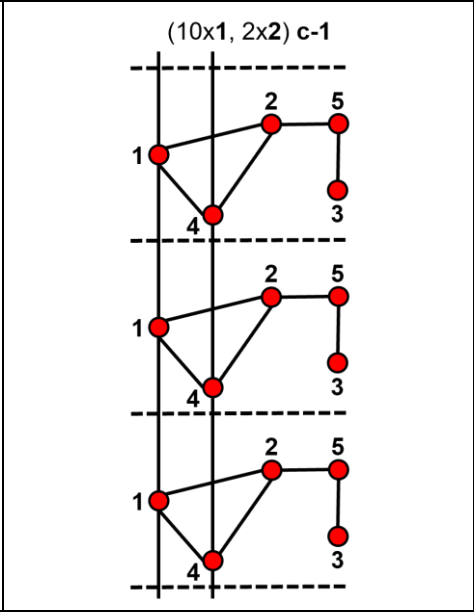
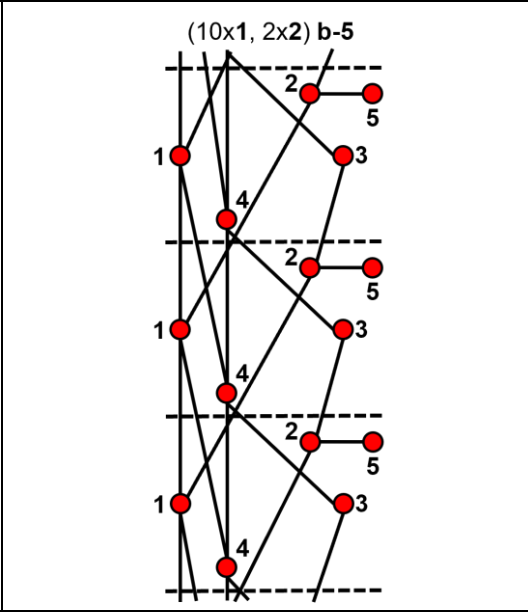
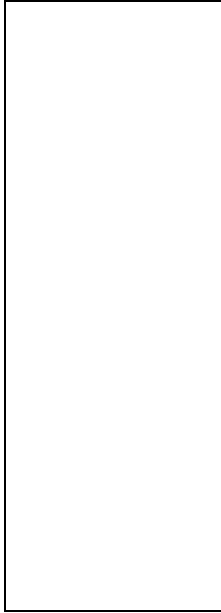

(10x1, 2x2) c-4

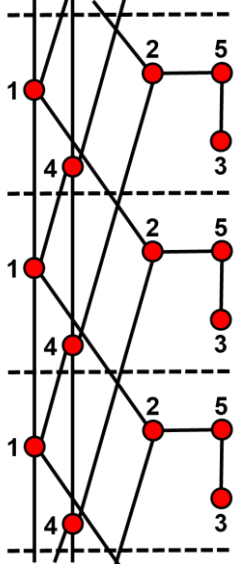

(10x1, 2x2) d-1

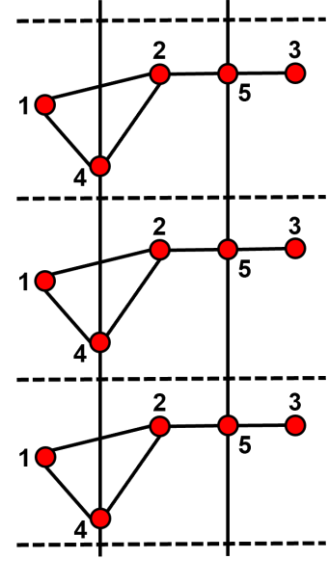

(10x1, 2x2) d-2

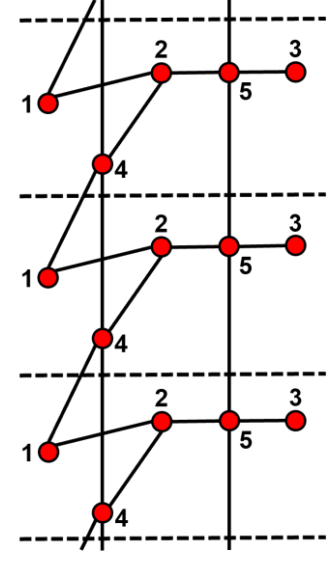

(10x1, 2x2) d-3

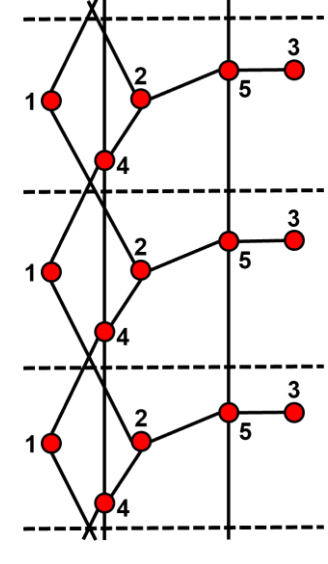

(10x1, 2x2) d-4

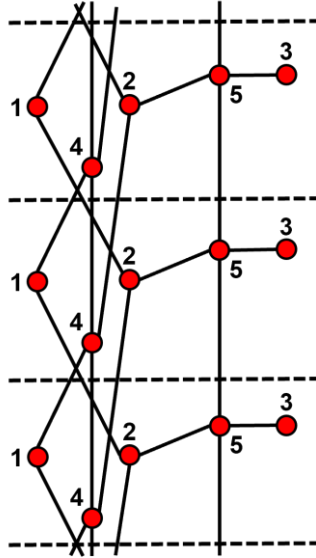

(10x1, 2x2) e-1

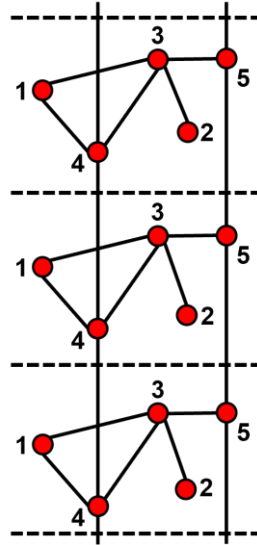

(10x1, 2x2) e-2

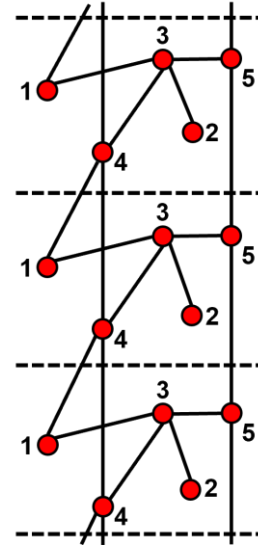

(10x1, 2x2) e-3

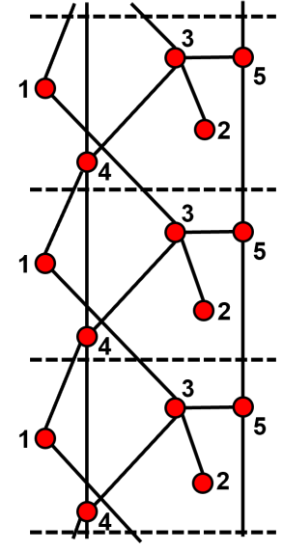

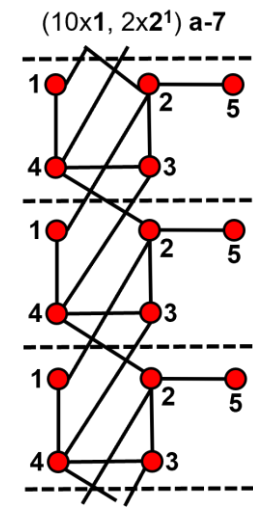
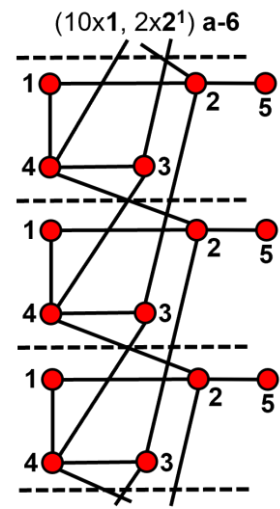
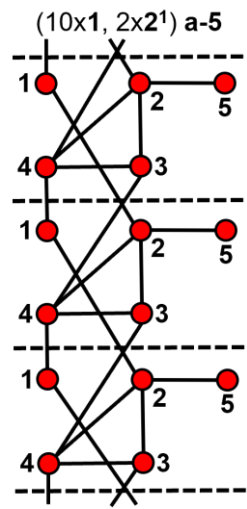
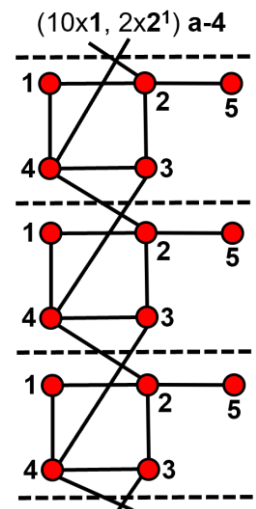
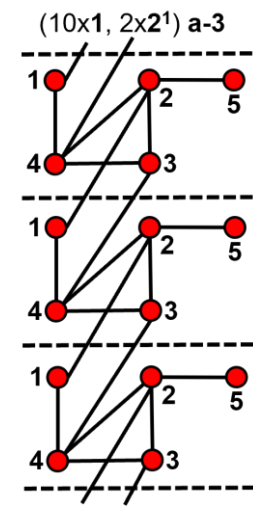
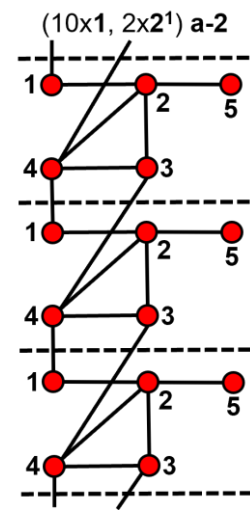
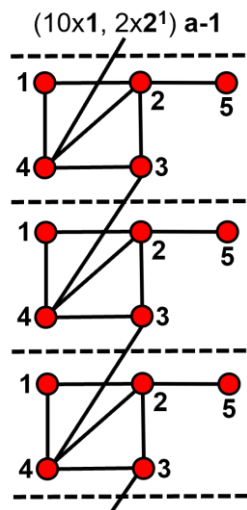
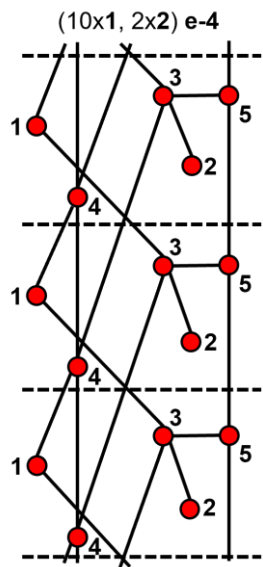

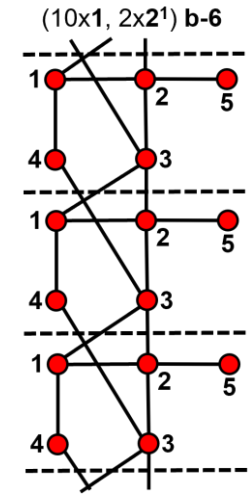
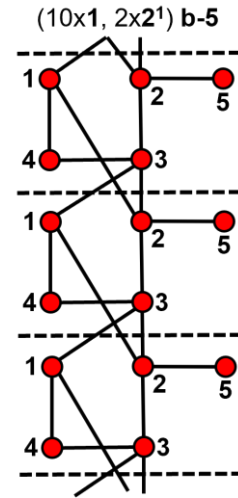
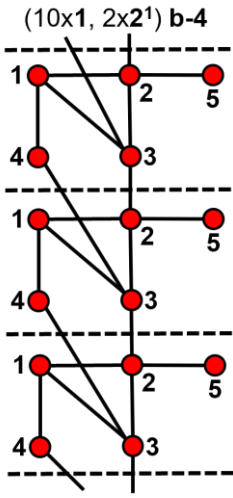
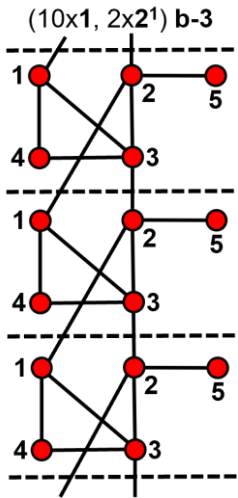
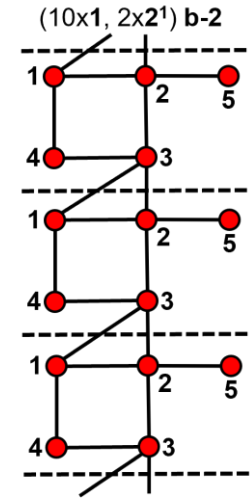
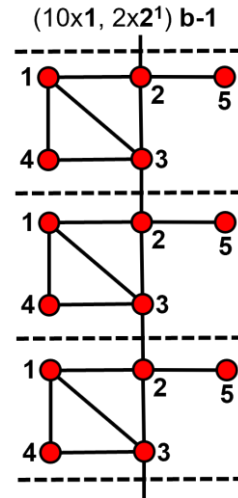
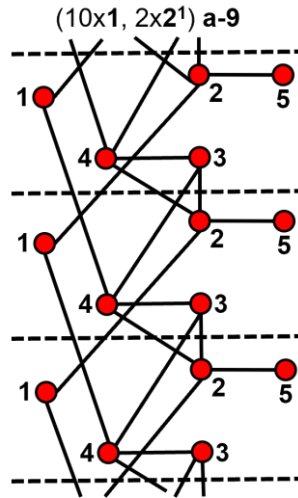
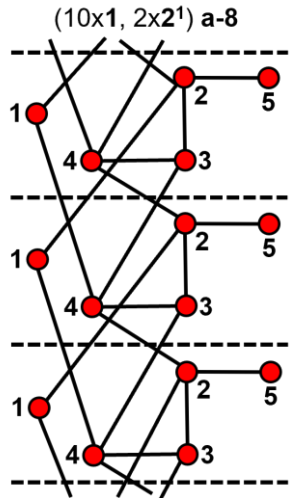



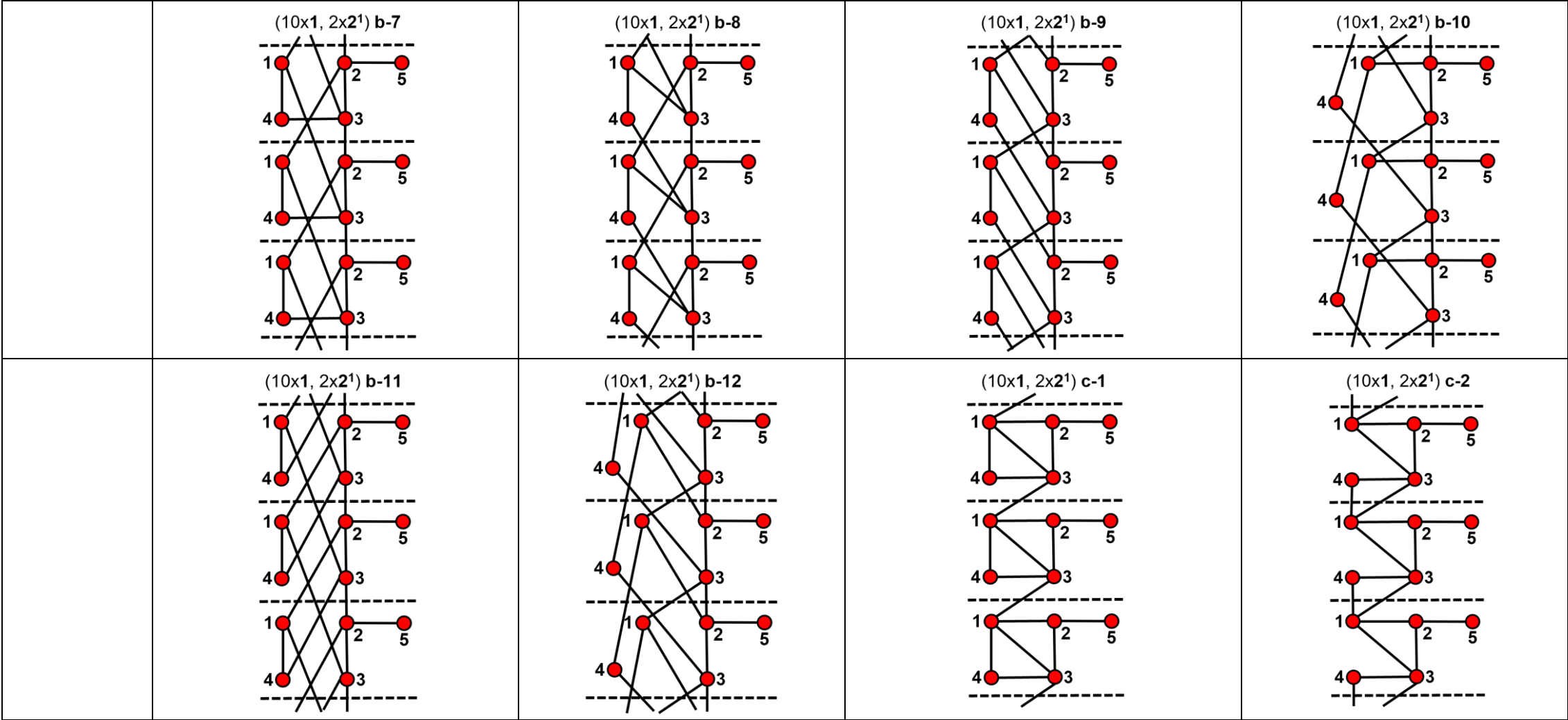

(10x1, 2x2<sup>1</sup>) c-3

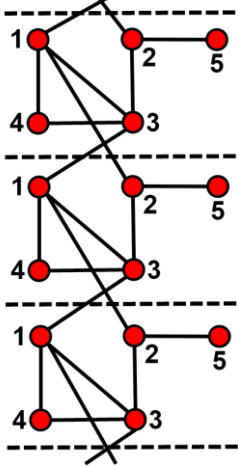

(10x1, 2x2<sup>1</sup>) c-4

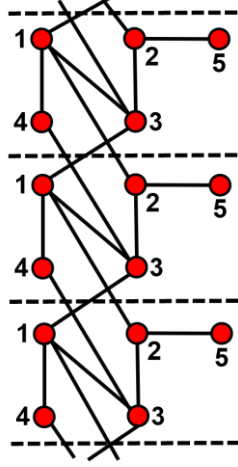

(10x1, 2x2<sup>1</sup>) c-5

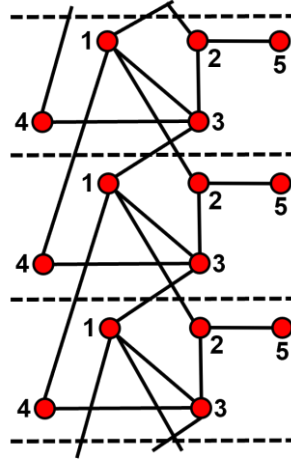

(10x1, 2x2<sup>1</sup>) c-6

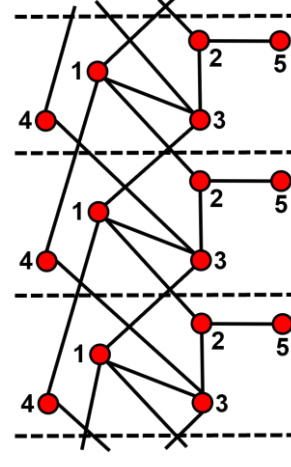

(10x1, 2x2<sup>1</sup>) c-7

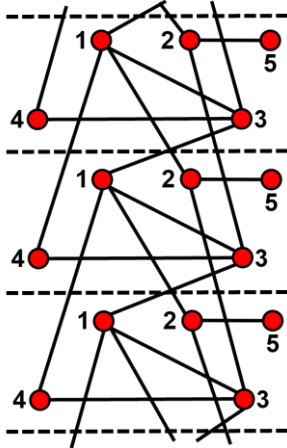

(10x1, 2x2<sup>1</sup>) c-8

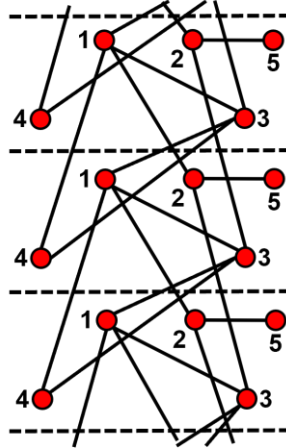

(10x1, 2x2<sup>2</sup>) a-1

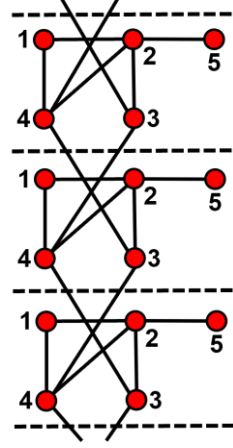

(10x1, 2x2<sup>2</sup>) a-2

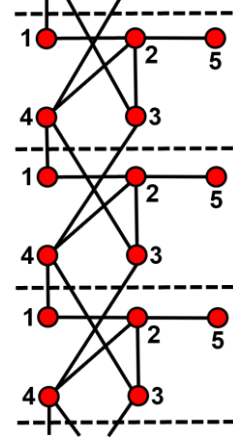

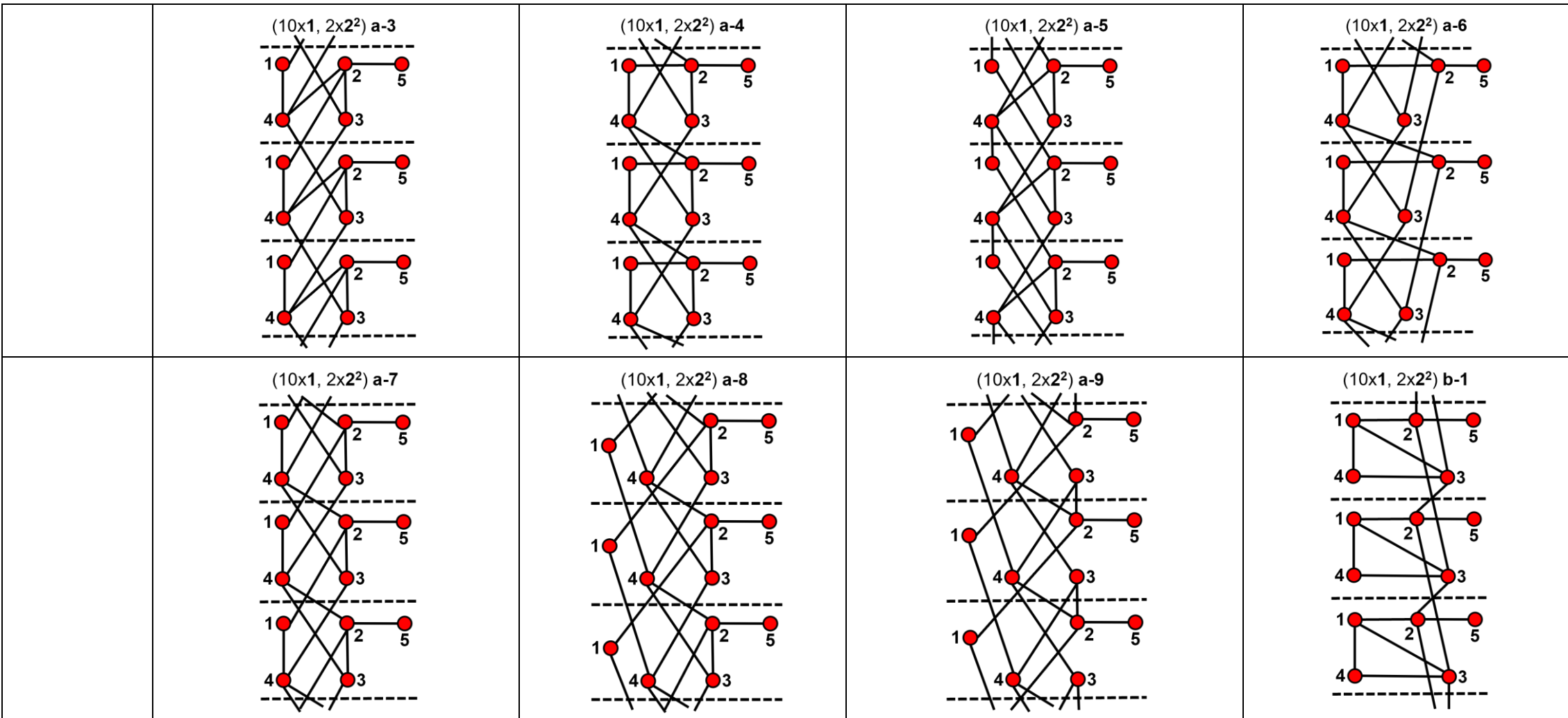

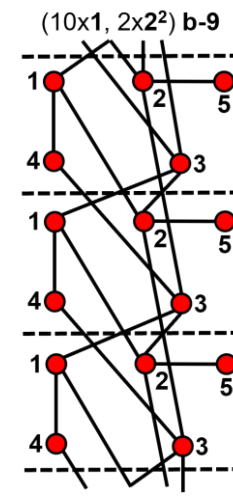
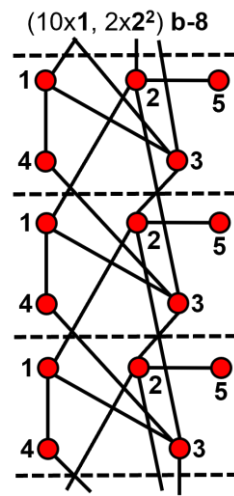
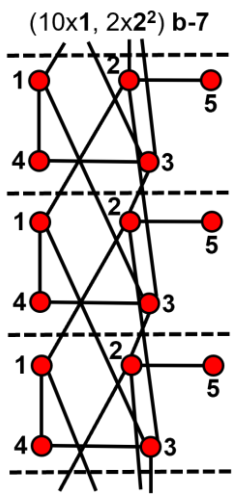
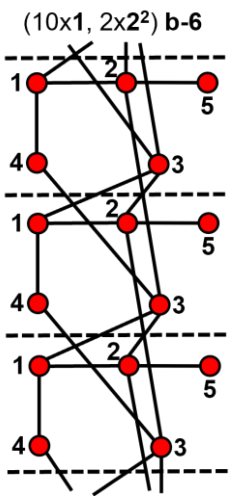
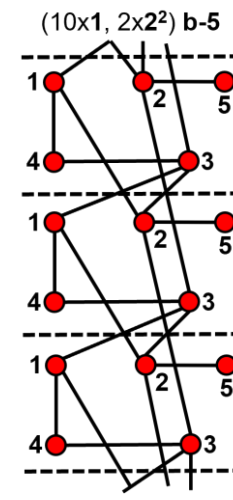
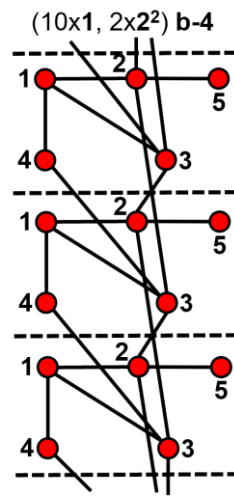
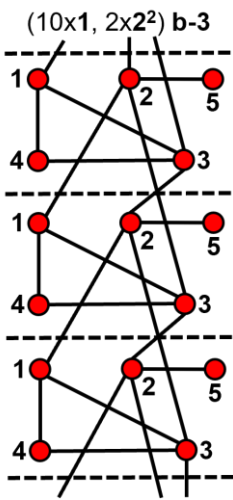
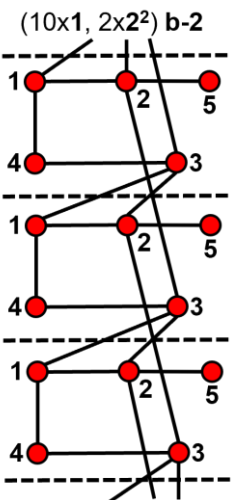

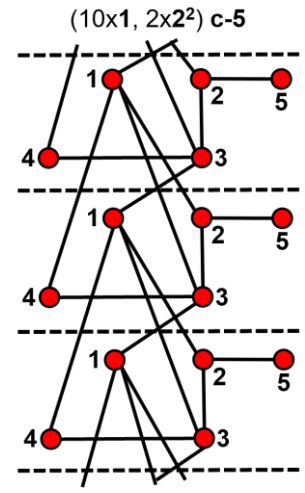
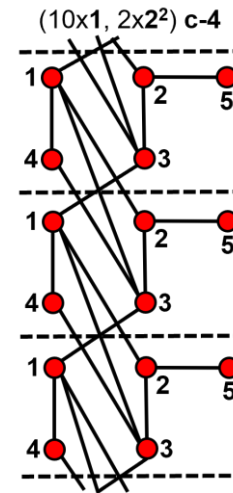
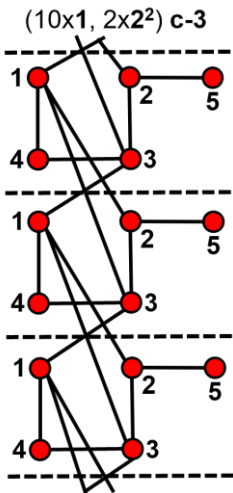
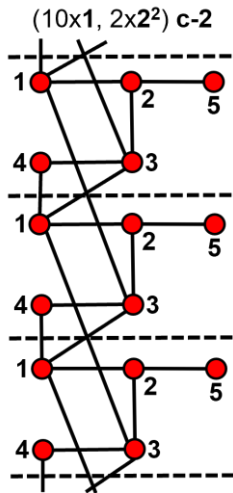
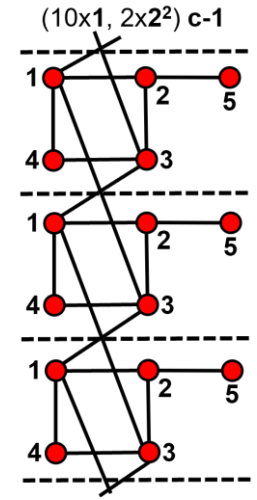
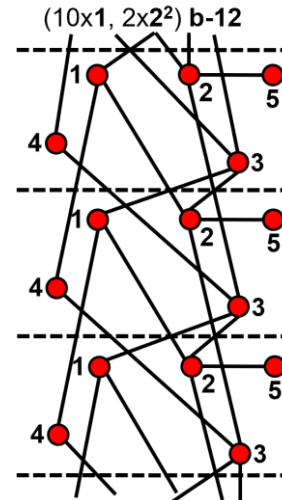
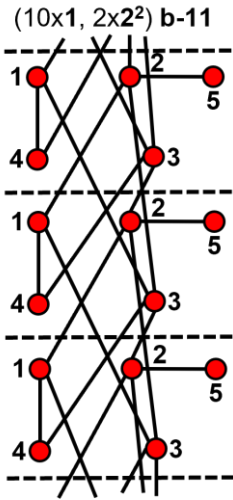
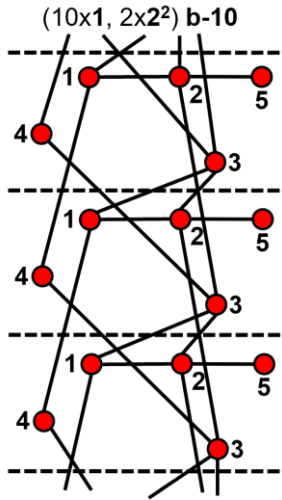

(10x1, 2x2<sup>2</sup>) c-6

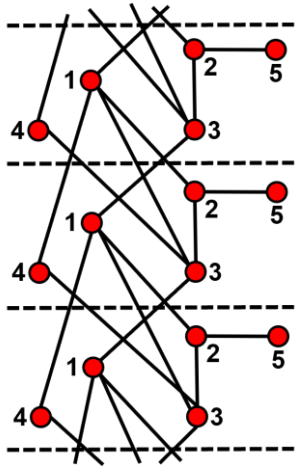

(10x1, 2x2<sup>2</sup>) c-7

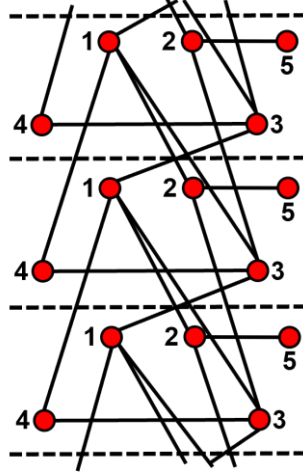

(10x1, 2x2<sup>2</sup>) c-8

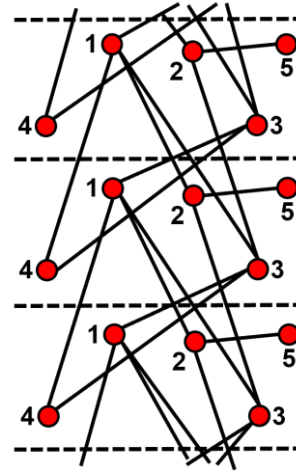

(8x1, 3x2) a

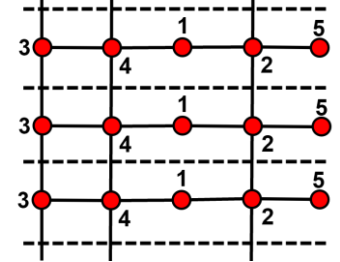

(8x1, 3x2) b

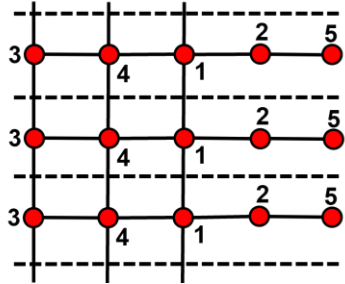

(8x1, 3x2) c

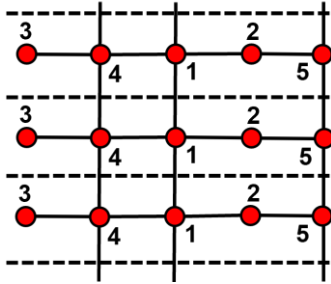

(8x1, 3x2) d-1

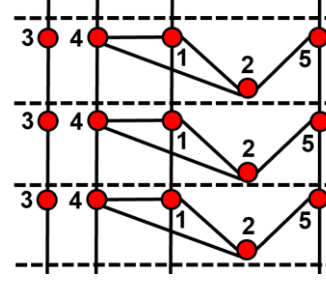

(8x1, 3x2) d-2

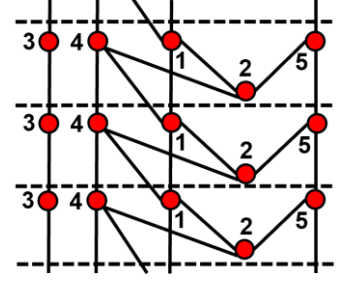

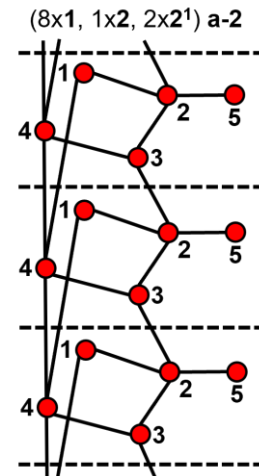
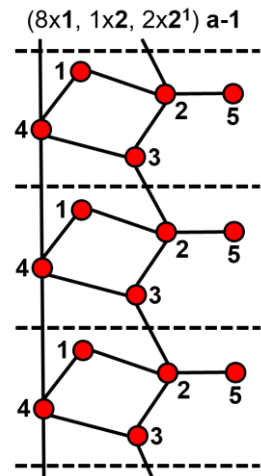
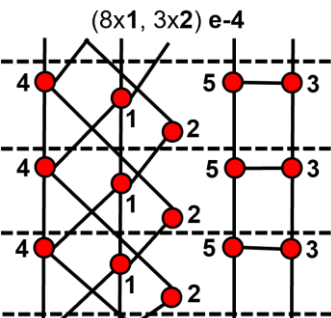
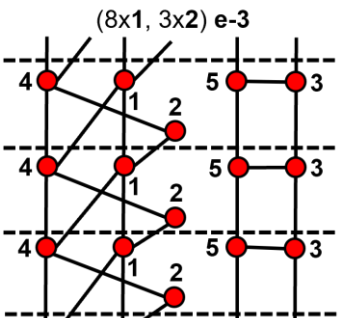
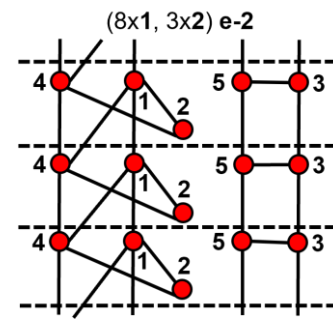
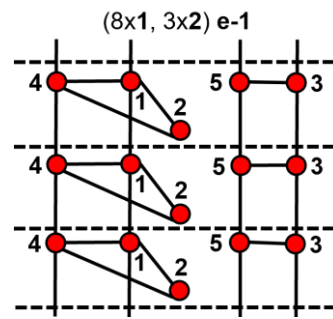
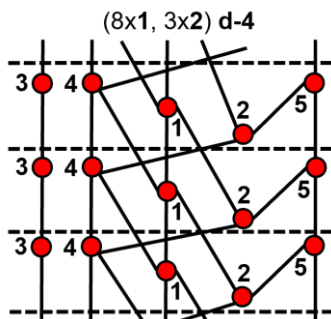
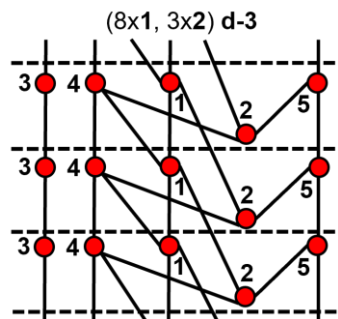

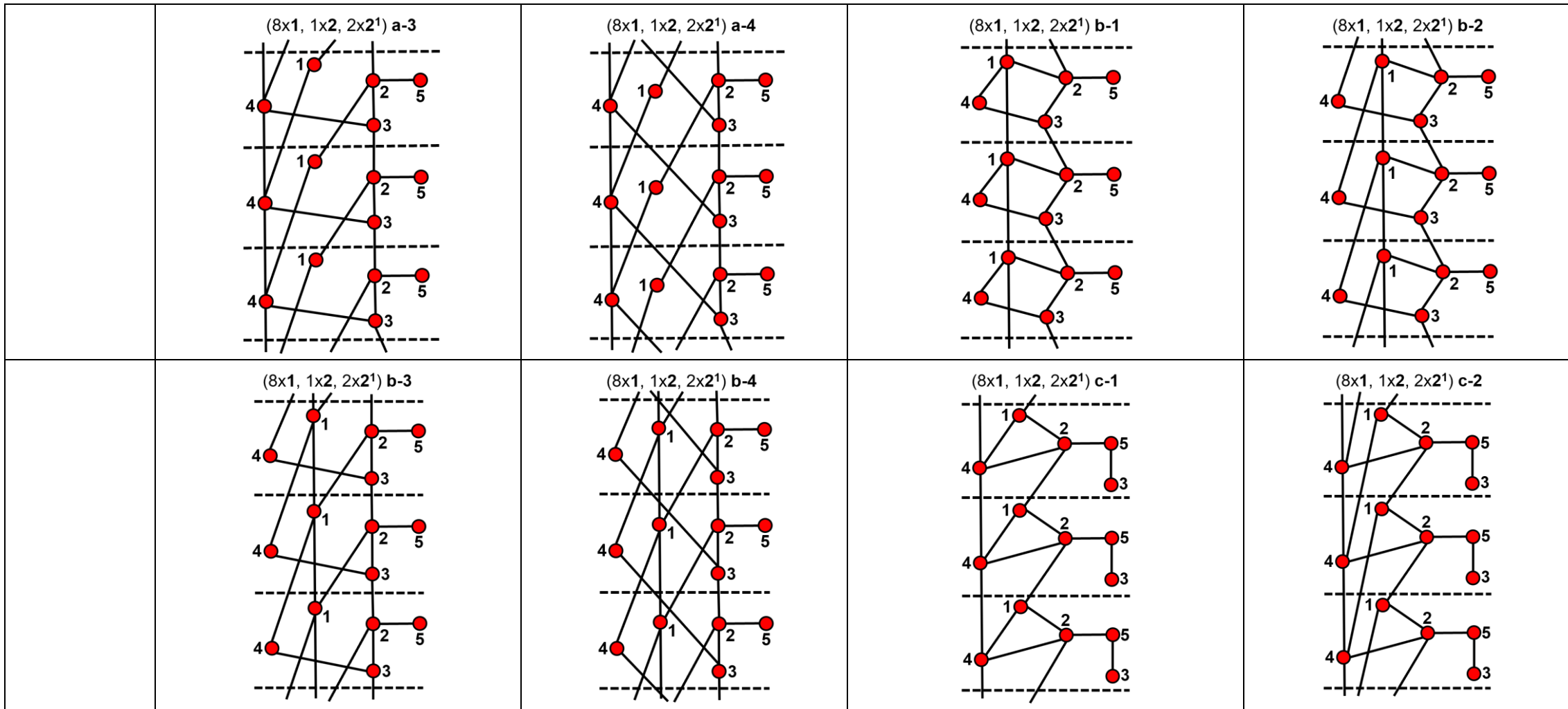



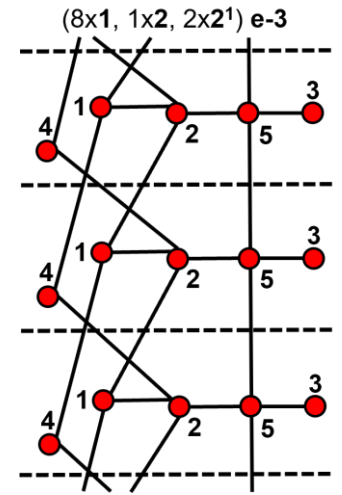
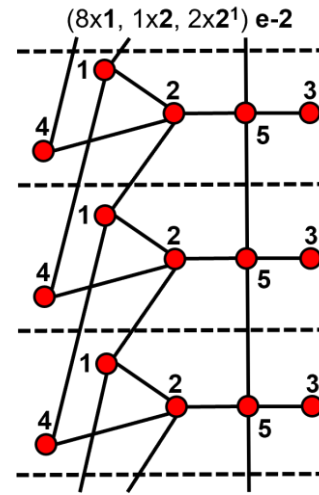
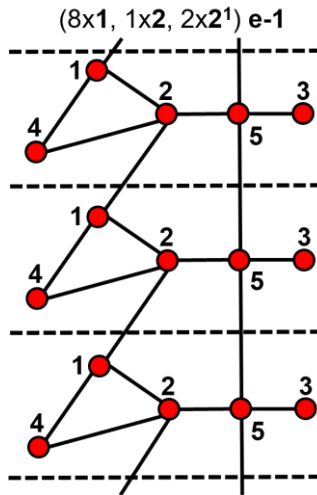
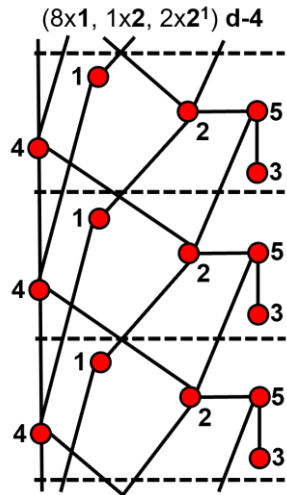
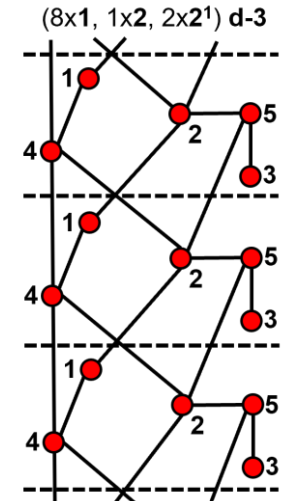
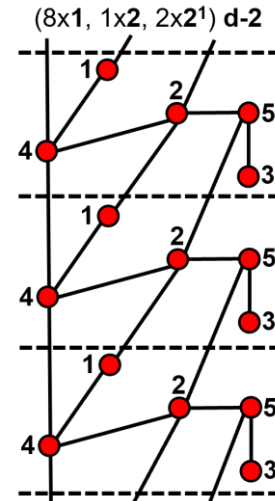
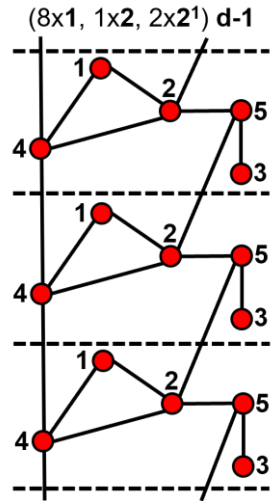
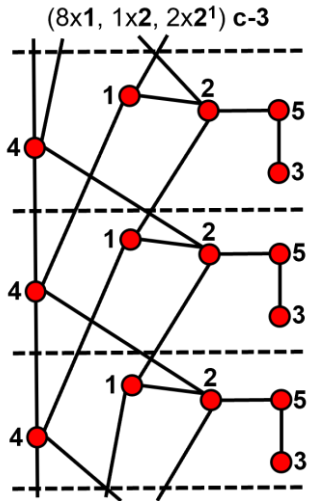

(8x1, 1x2, 2x2<sup>1</sup>) f-1

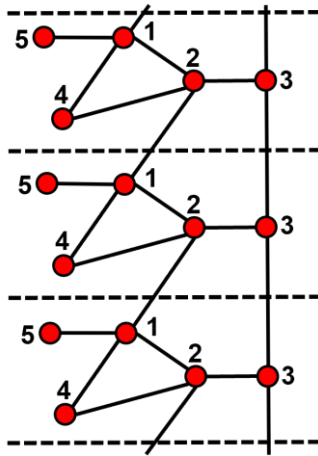

(8x1, 1x2, 2x2<sup>1</sup>) f-2

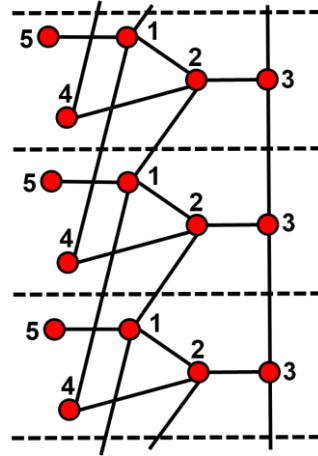

(8x1, 1x2, 2x2<sup>1</sup>) f-3

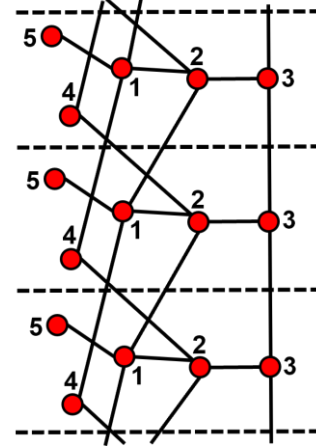

(8x1, 1x2, 2x2<sup>1</sup>) g-1

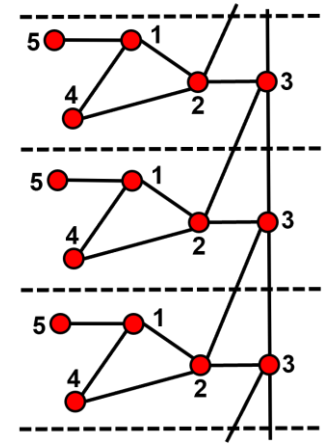

(8x1, 1x2, 2x2<sup>1</sup>) g-2

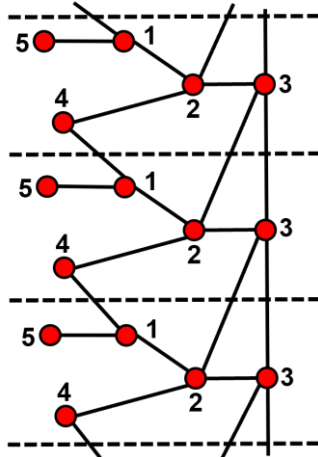

(8x1, 1x2, 2x2<sup>1</sup>) g-3

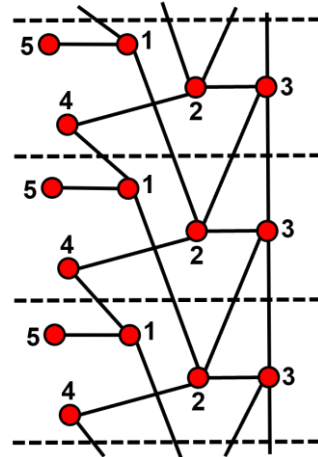

(8x1, 1x2, 2x2<sup>1</sup>) g-4

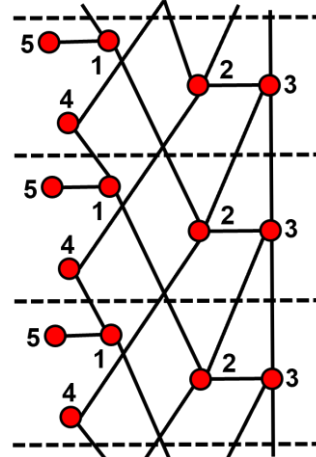

(8x1, 1x2, 2x2<sup>1</sup>) h-1

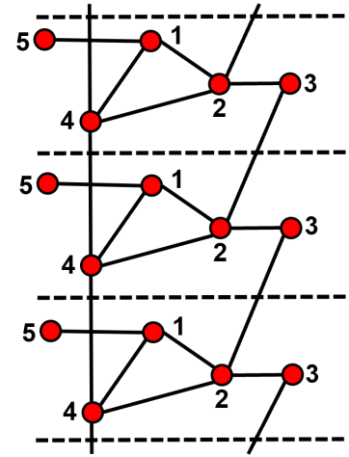

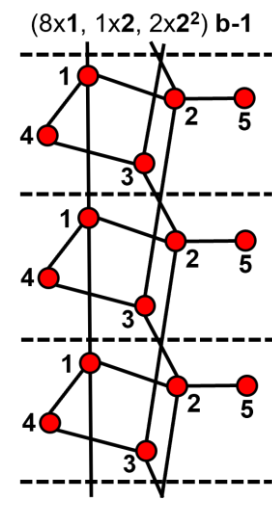
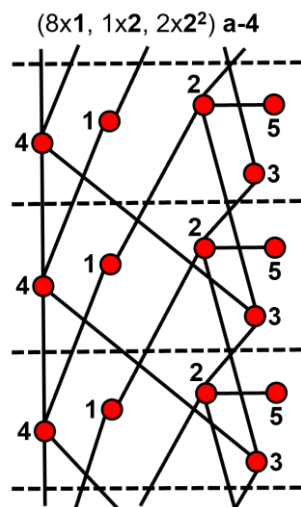
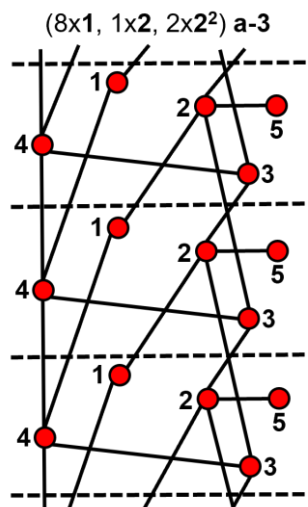
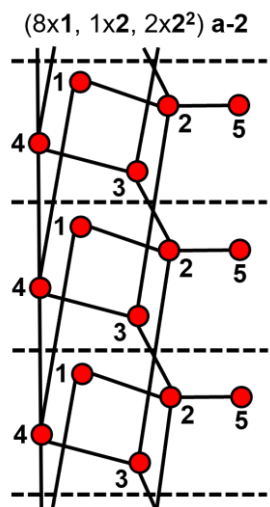
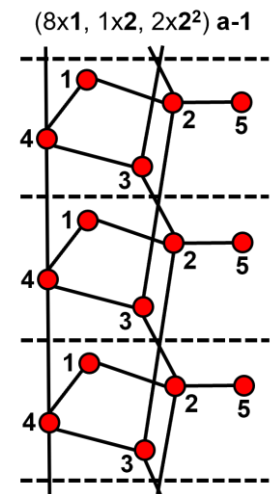
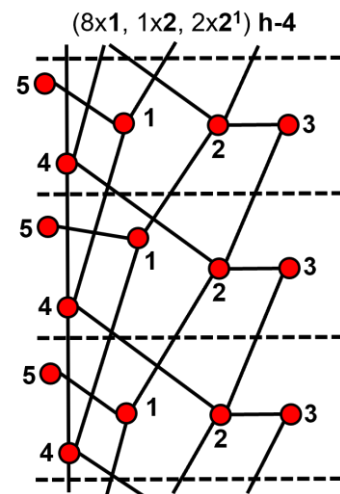
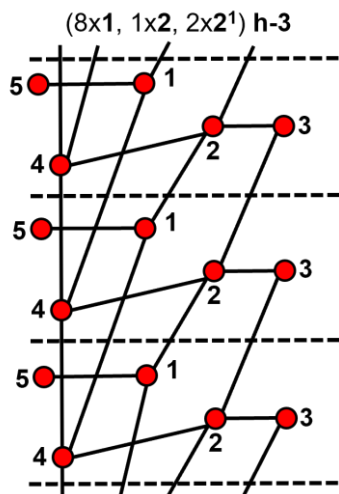
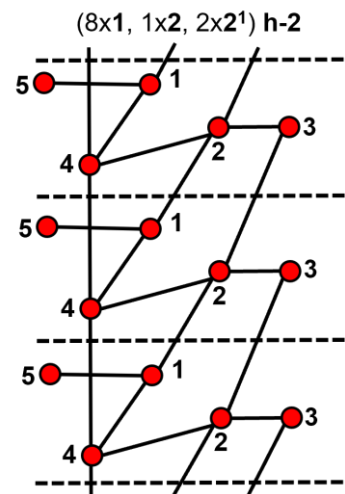

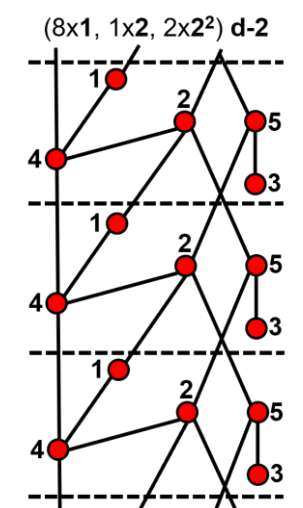
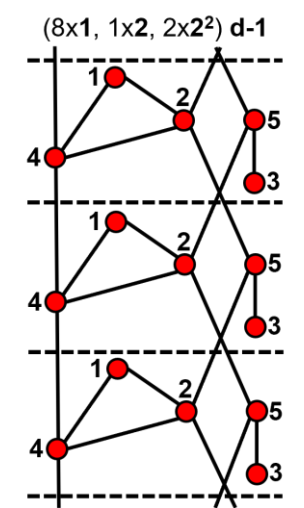
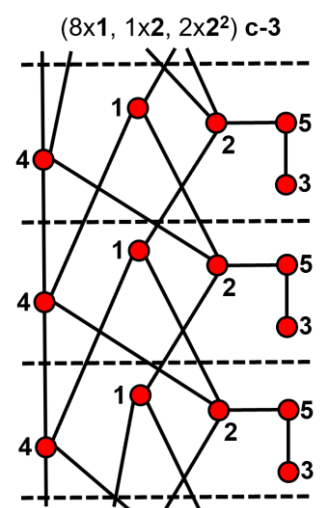
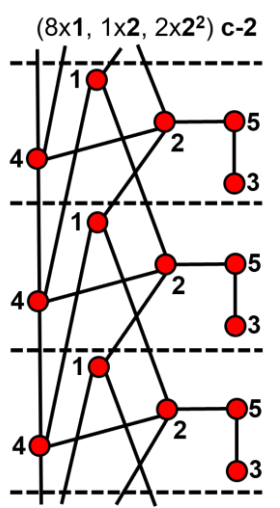
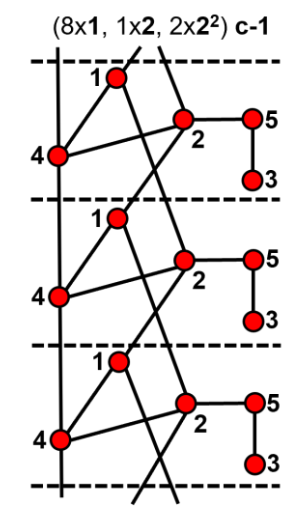
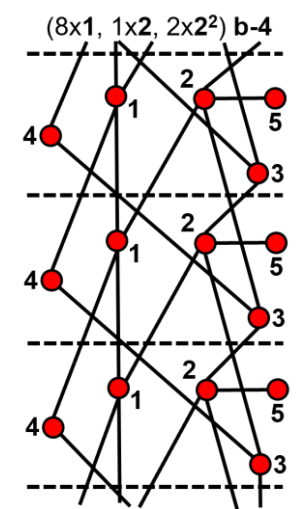
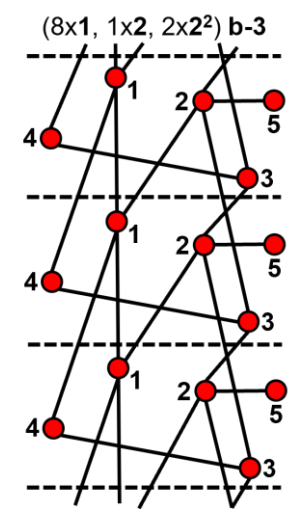
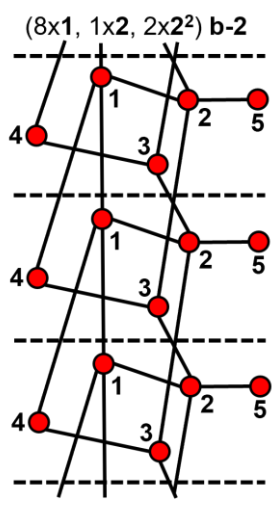

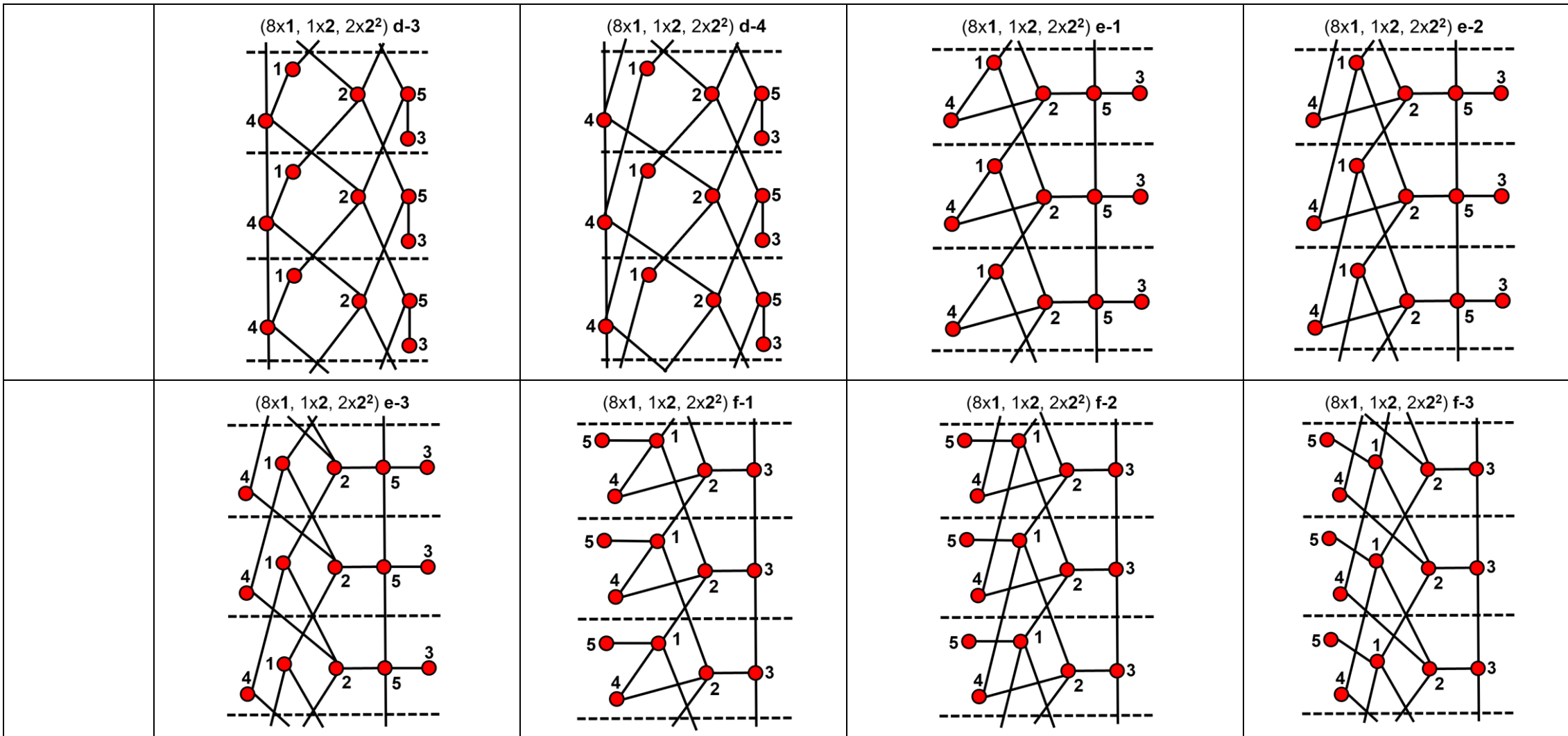

$(8 \times 1, 1 \times 2, 2 \times 2^2) \mathbf{g-1}$

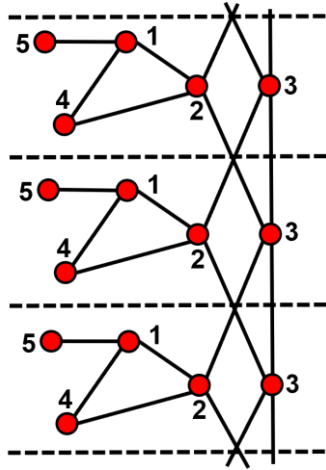

$(8 \times 1, 1 \times 2, 2 \times 2^2) \mathbf{g-2}$

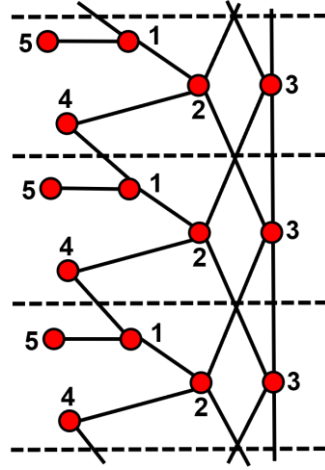

$(8 \times 1, 1 \times 2, 2 \times 2^2) \mathbf{g-3}$

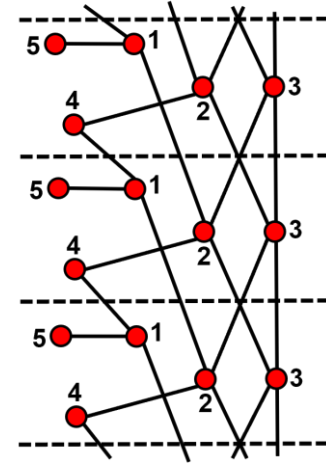

$(8 \times 1, 1 \times 2, 2 \times 2^2) \mathbf{g-4}$

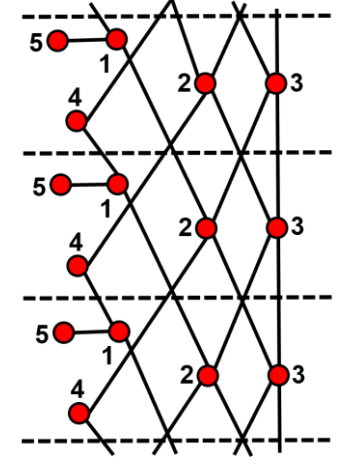

$(8 \times 1, 1 \times 2, 2 \times 2^2) \mathbf{h-1}$

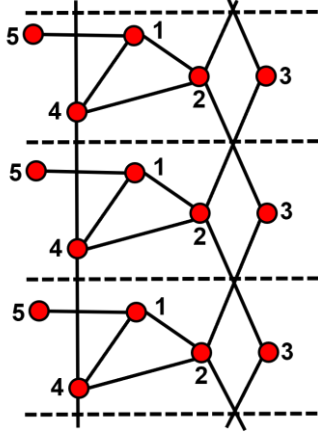

$(8 \times 1, 1 \times 2, 2 \times 2^2) \mathbf{h-2}$

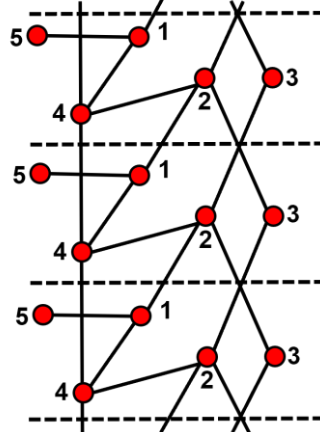

$(8 \times 1, 1 \times 2, 2 \times 2^2) \mathbf{h-3}$

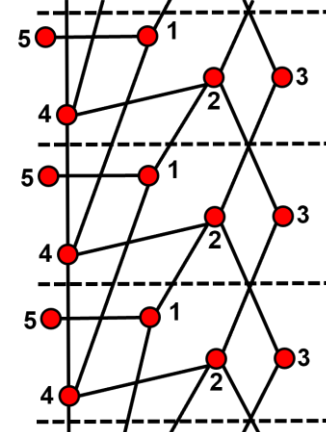

$(8 \times 1, 1 \times 2, 2 \times 2^2) \mathbf{h-4}$

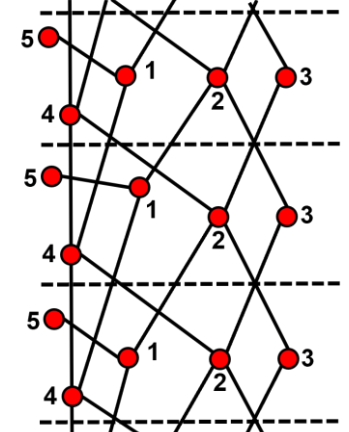

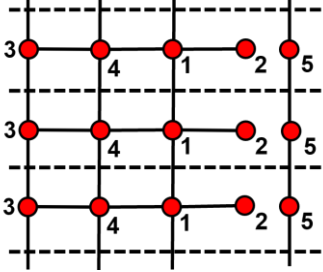
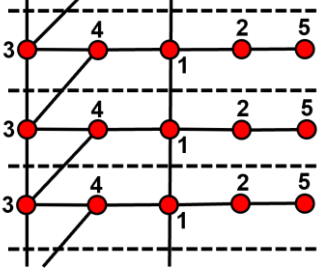
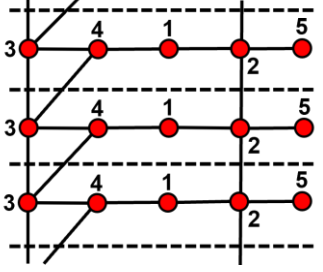
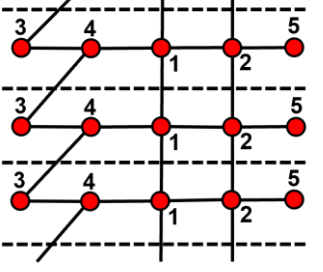
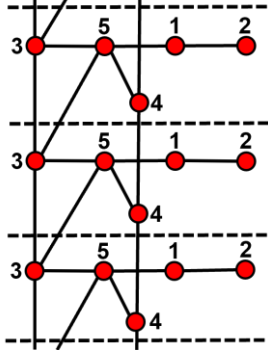
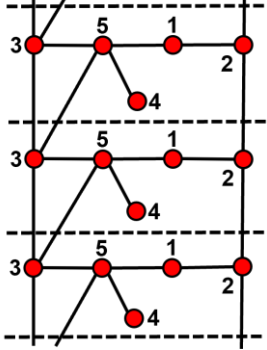
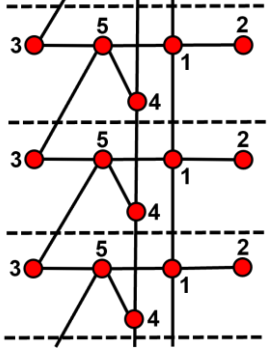
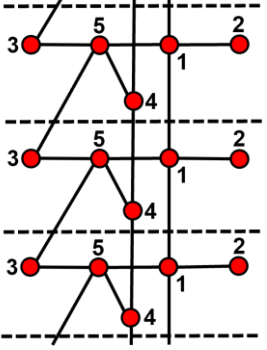
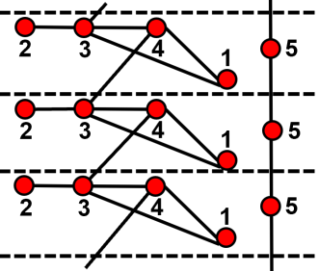
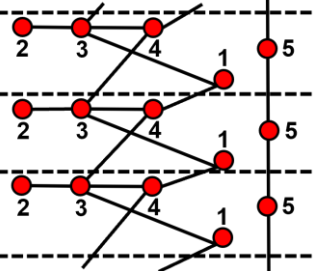
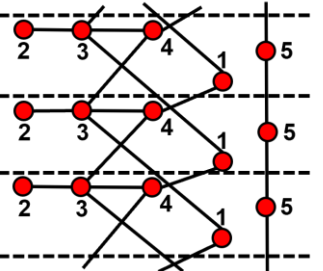
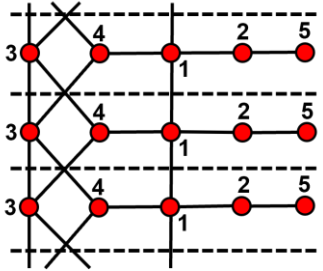
	<p>(6x1, 4x2)</p> 	<p>(6x1, 2x2, 2x2<sup>1</sup>) a</p> 	<p>(6x1, 2x2, 2x2<sup>1</sup>) b</p> 	<p>(6x1, 2x2, 2x2<sup>1</sup>) c</p> 
	<p>(6x1, 2x2, 2x2<sup>1</sup>) d</p> 	<p>(6x1, 2x2, 2x2<sup>1</sup>) e</p> 	<p>(6x1, 2x2, 2x2<sup>1</sup>) f</p> 	<p>(6x1, 2x2, 2x2<sup>1</sup>) g</p> 
	<p>(6x1, 2x2, 2x2<sup>1</sup>) h-1</p> 	<p>(6x1, 2x2, 2x2<sup>1</sup>) h-2</p> 	<p>(6x1, 2x2, 2x2<sup>1</sup>) h-3</p> 	<p>(6x1, 2x2, 2x2<sup>2</sup>) a</p> 

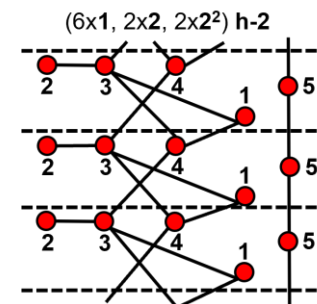
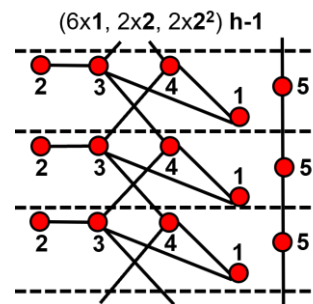
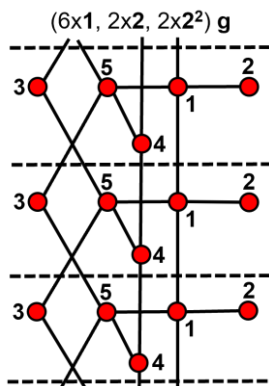
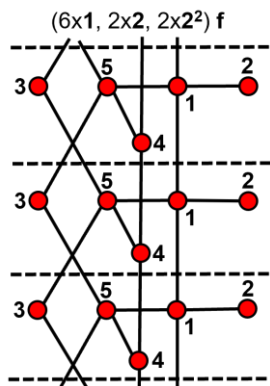
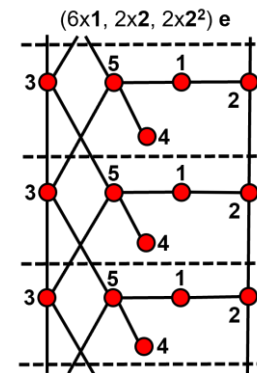
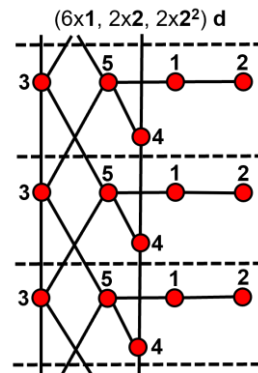
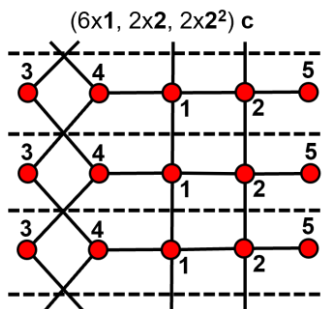
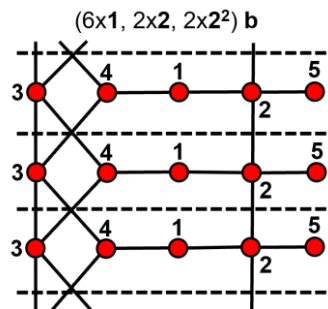

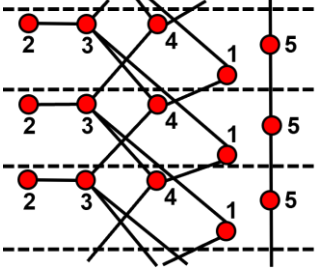
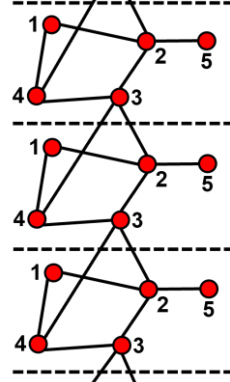
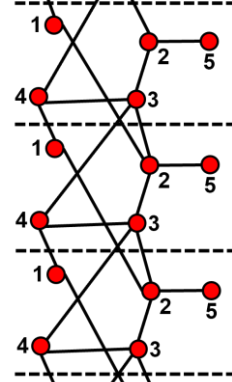
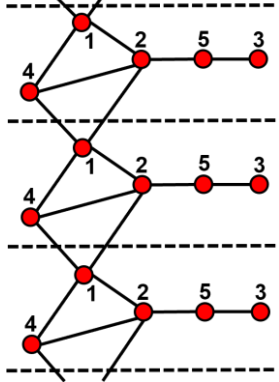
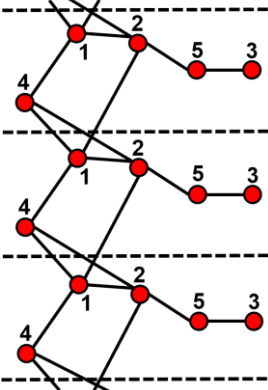
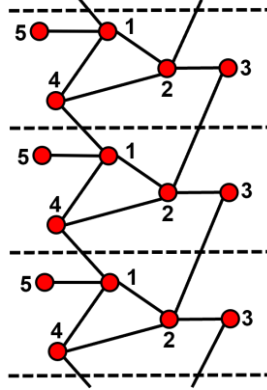
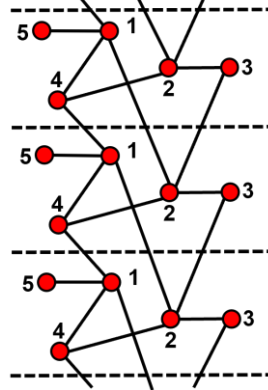
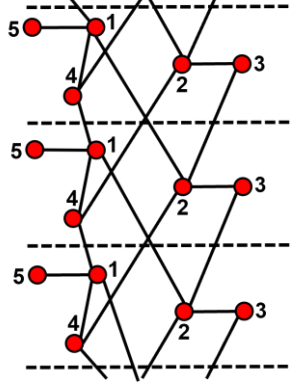

	<p>(6x1, 2x2, 2x2<sup>2</sup>) h-3</p> 	<p>(6x1, 4x2<sup>1</sup>) a-1</p> 	<p>(6x1, 4x2<sup>1</sup>) a-2</p> 	<p>(6x1, 4x2<sup>1</sup>) b-1</p> 
	<p>(6x1, 4x2<sup>1</sup>) b-2</p> 	<p>(6x1, 4x2<sup>1</sup>) c-1</p> 	<p>(6x1, 4x2<sup>1</sup>) c-2</p> 	<p>(6x1, 4x2<sup>1</sup>) c-3</p> 

(6x1, 2x2<sup>1</sup>, 2x2<sup>2</sup>) a-1

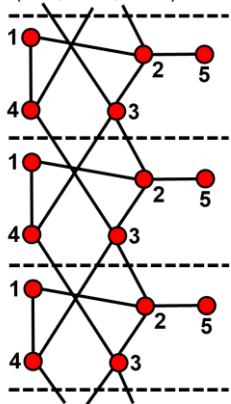

(6x1, 2x2<sup>1</sup>, 2x2<sup>2</sup>) a-2

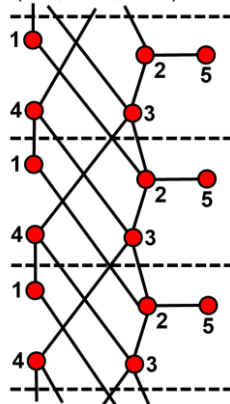

(6x1, 2x2<sup>1</sup>, 2x2<sup>2</sup>) b-1

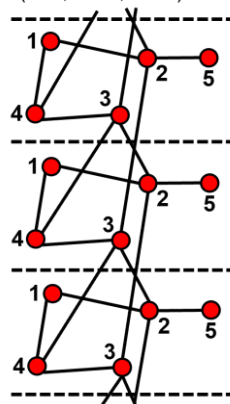

(6x1, 2x2<sup>1</sup>, 2x2<sup>2</sup>) b-2

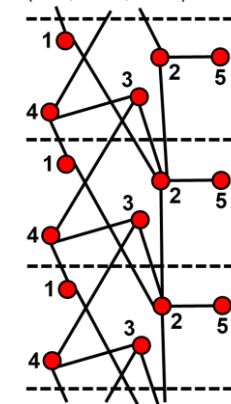

(6x1, 2x2<sup>1</sup>, 2x2<sup>2</sup>) c-1

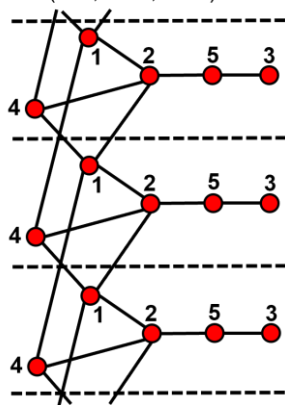

(6x1, 2x2<sup>1</sup>, 2x2<sup>2</sup>) c-2

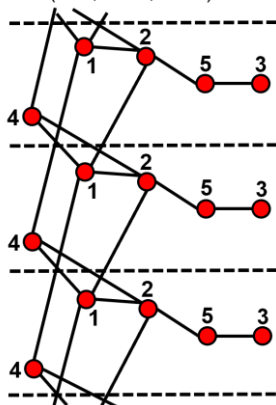

(6x1, 2x2<sup>1</sup>, 2x2<sup>2</sup>) d-1

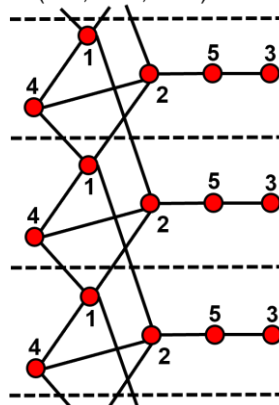

(6x1, 2x2<sup>1</sup>, 2x2<sup>2</sup>) d-2

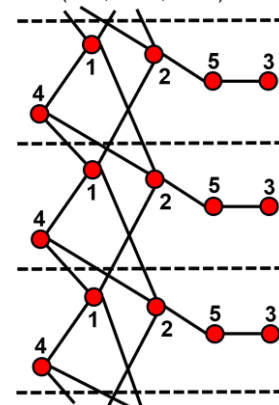

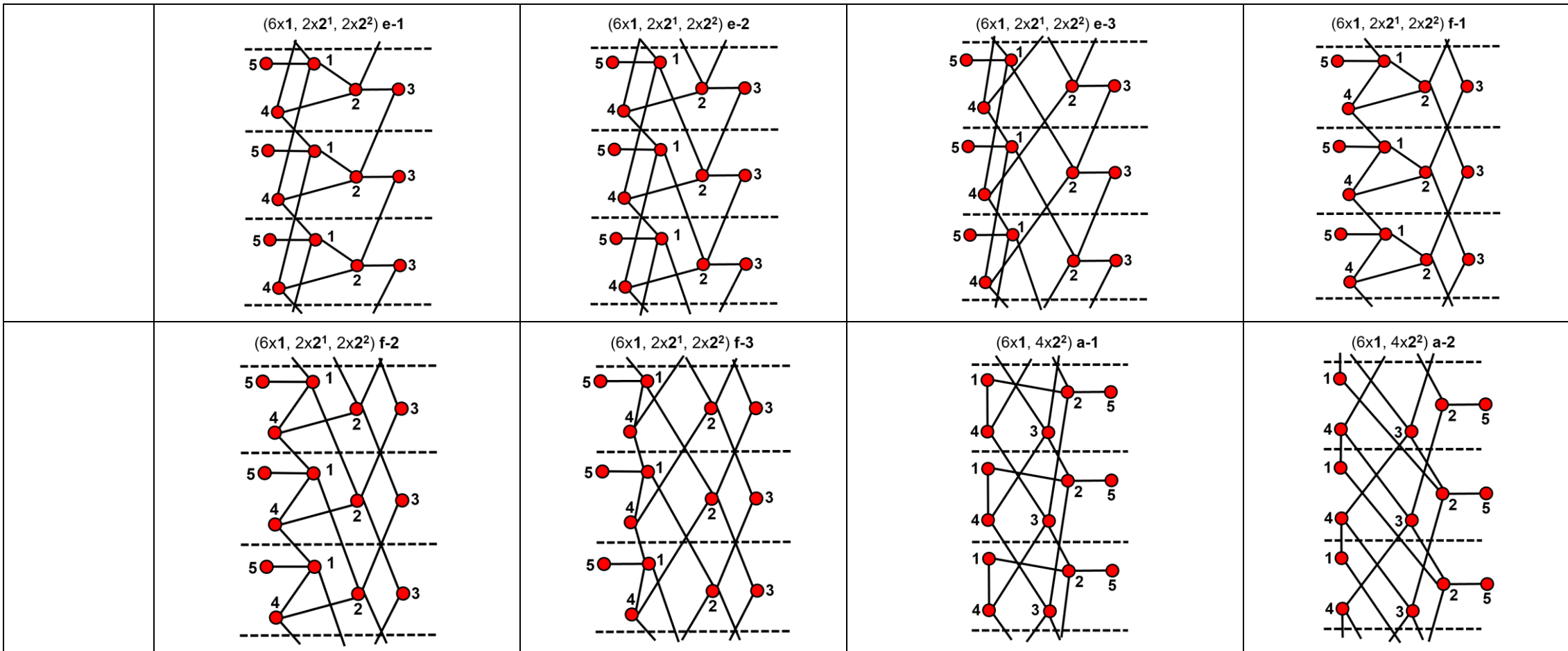

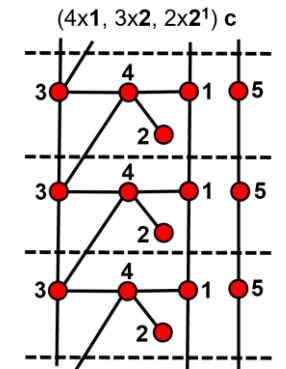
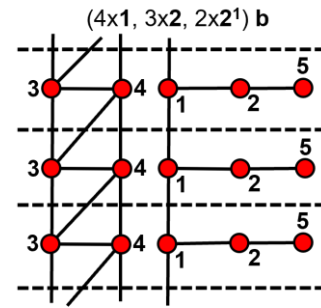
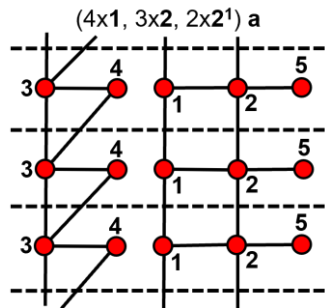
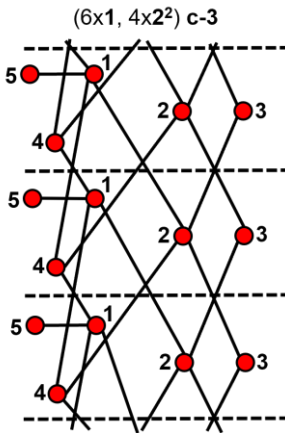
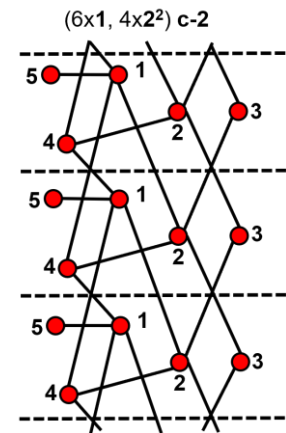
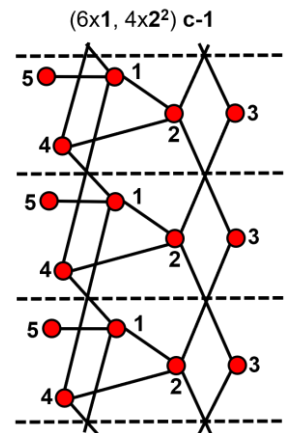
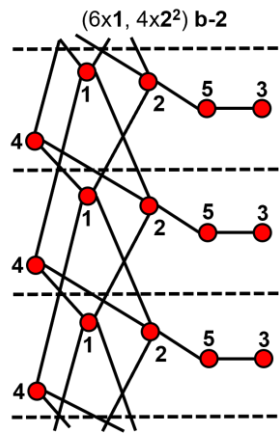
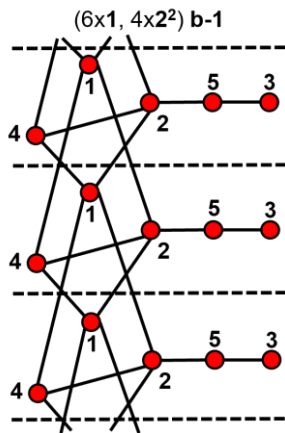

	<p>(4x1, 3x2, 2x2<sup>1</sup>) d</p>	<p>(4x1, 3x2, 2x2<sup>2</sup>) a</p>	<p>(4x1, 3x2, 2x2<sup>2</sup>) b</p>	<p>(4x1, 3x2, 2x2<sup>2</sup>) c</p>
	<p>(4x1, 3x2, 2x2<sup>2</sup>) d</p>	<p>(4x1, 1x2, 4x2<sup>1</sup>) a</p>	<p>(4x1, 1x2, 4x2<sup>1</sup>) b</p>	<p>(4x1, 1x2, 4x2<sup>1</sup>) c</p>

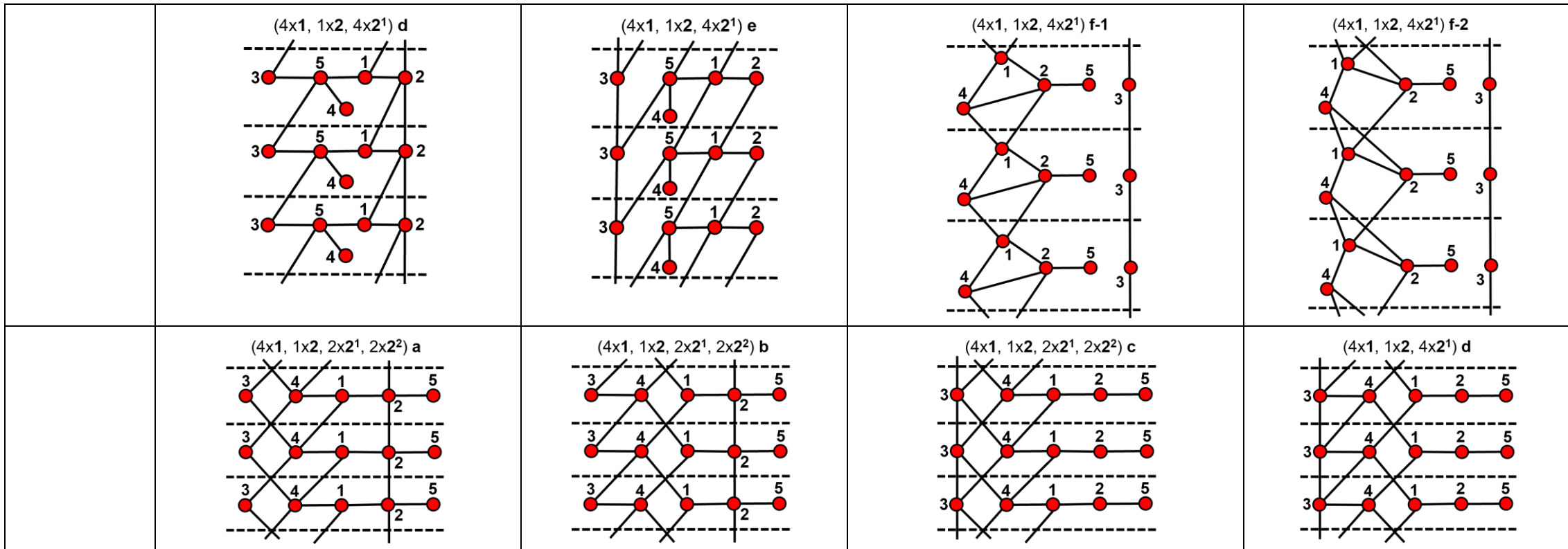

	<p>(4x1, 1x2, 2x2<sup>1</sup>, 2x2<sup>2</sup>) e</p>	<p>(4x1, 1x2, 2x2<sup>1</sup>, 2x2<sup>2</sup>) f</p>	<p>(4x1, 1x2, 2x2<sup>1</sup>, 2x2<sup>2</sup>) g</p>	<p>(4x1, 1x2, 2x2<sup>1</sup>, 2x2<sup>2</sup>) h</p>
	<p>(4x1, 1x2, 2x2<sup>1</sup>, 2x2<sup>2</sup>) i</p>	<p>(4x1, 1x2, 2x2<sup>1</sup>, 2x2<sup>2</sup>) j</p>	<p>(4x1, 1x2, 2x2<sup>1</sup>, 2x2<sup>2</sup>) k-1</p>	<p>(4x1, 1x2, 2x2<sup>1</sup>, 2x2<sup>2</sup>) k-2</p>

(4x1, 1x2, 2x2<sup>1</sup>, 2x2<sup>2</sup>) I-1

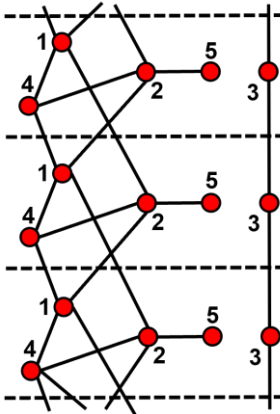

(4x1, 1x2, 2x2<sup>1</sup>, 2x2<sup>2</sup>) I-2

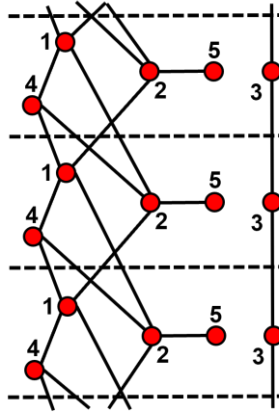

(4x1, 1x2, 4x2<sup>2</sup>) a

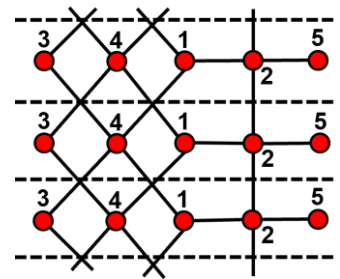

(4x1, 1x2, 4x2<sup>2</sup>) b

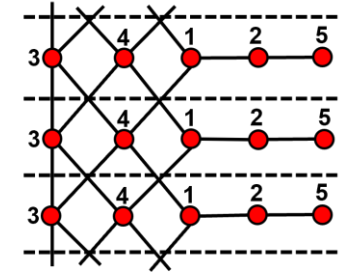

(4x1, 1x2, 4x2<sup>2</sup>) c

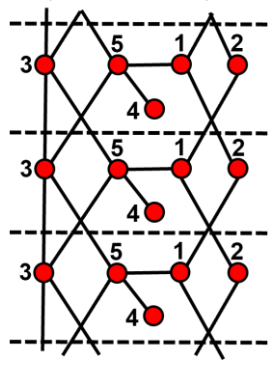

(4x1, 1x2, 4x2<sup>2</sup>) d

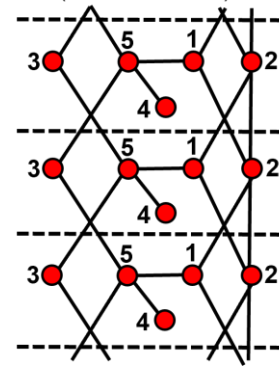

(4x1, 1x2, 4x2<sup>2</sup>) e

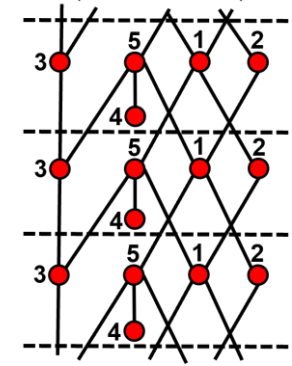

(4x1, 1x2, 4x2<sup>2</sup>) f-1

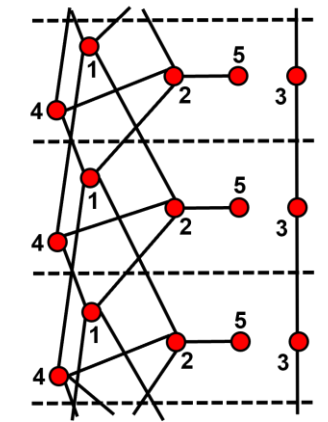



	<p>(4x1, 1x2, 4x2<sup>2</sup>) f-2</p>	<p>(2x1, 4x2, 2x2<sup>1</sup>)</p>	<p>(2x1, 4x2, 2x2<sup>2</sup>)</p>	<p>(2x1, 2x2, 4x2<sup>1</sup>) a</p>
	<p>(2x1, 2x2, 4x2<sup>1</sup>) b</p>	<p>(2x1, 2x2, 4x2<sup>1</sup>) c</p>	<p>(2x1, 2x2, 4x2<sup>1</sup>) d</p>	<p>(2x1, 2x2, 2x2<sup>1</sup>, 2x2<sup>2</sup>) a</p>
	<p>(2x1, 2x2, 2x2<sup>1</sup>, 2x2<sup>2</sup>) b</p>	<p>(2x1, 2x2, 2x2<sup>1</sup>, 2x2<sup>2</sup>) c</p>	<p>(2x1, 2x2, 2x2<sup>1</sup>, 2x2<sup>2</sup>) d</p>	<p>(2x1, 2x2, 2x2<sup>1</sup>, 2x2<sup>2</sup>) e</p>

	<p>(2x1, 2x2, 2x2<sup>1</sup>, 2x2<sup>2</sup>) f</p>	<p>(2x1, 2x2, 2x2<sup>1</sup>, 2x2<sup>2</sup>) g</p>	<p>(2x1, 2x2, 2x2<sup>1</sup>, 2x2<sup>2</sup>) h</p>	<p>(2x1, 2x2, 4x2<sup>2</sup>) a</p>
	<p>(2x1, 2x2, 4x2<sup>2</sup>) b</p>	<p>(2x1, 2x2, 4x2<sup>2</sup>) c</p>	<p>(2x1, 2x2, 4x2<sup>2</sup>) d</p>	<p>(2x1, 6x2<sup>1</sup>)</p>
	<p>(2x1, 4x2<sup>1</sup>, 2x2<sup>2</sup>) a</p>	<p>(2x1, 4x2<sup>1</sup>, 2x2<sup>2</sup>) b</p>	<p>(2x1, 4x2<sup>1</sup>, 2x2<sup>2</sup>) c</p>	<p>(2x1, 2x2<sup>1</sup>, 4x2<sup>2</sup>) a</p>

	(2x1, 2x2 <sup>1</sup> , 4x2 <sup>2</sup> ) b	(2x1, 2x2 <sup>1</sup> , 4x2 <sup>2</sup> ) c	(2x1, 6x2 <sup>2</sup> )	
${}^1V_1{}^2V_1{}^3V_1{}^4V_3$	NG			
${}^1V_1{}^2V_1{}^3V_1{}^4V_4$	NG			
${}^1V_1{}^2V_1{}^3V_1{}^4V_5$	NG			
${}^1V_1{}^2V_1{}^3V_3{}^4V_1$	NG			
${}^1V_1{}^2V_1{}^3V_3{}^4V_2$	NG			
${}^1V_1{}^2V_1{}^3V_3{}^4V_3$	NG			
${}^1V_1{}^2V_1{}^3V_5{}^4V_1$	NG			

${}^1V_1{}^2V_2{}^3V_1{}^4V_1$

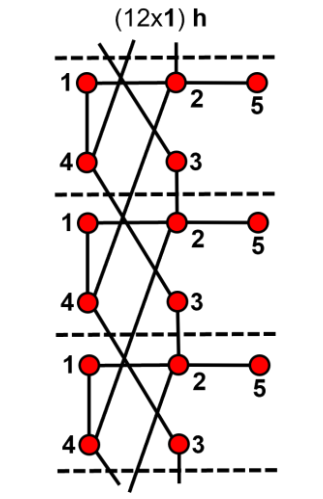
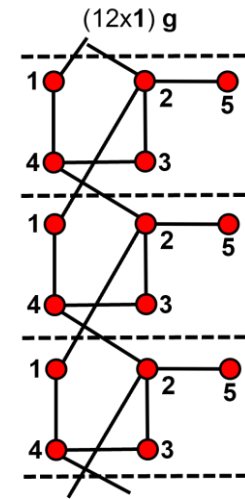
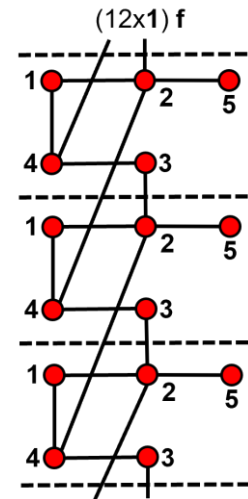
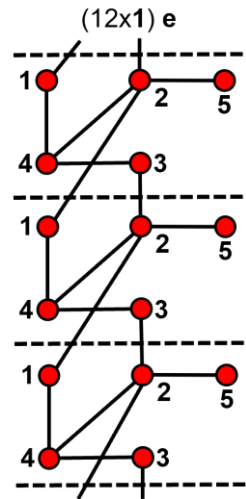
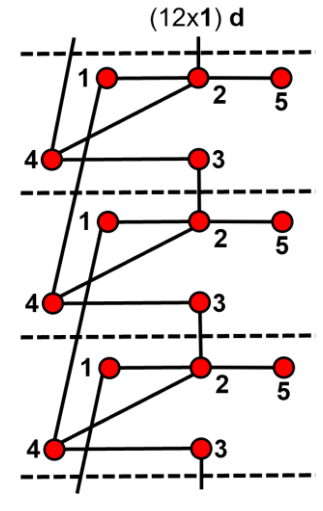
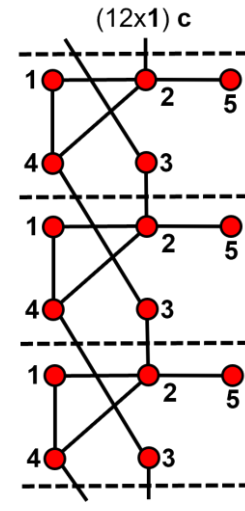
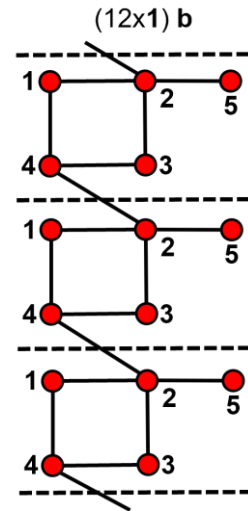
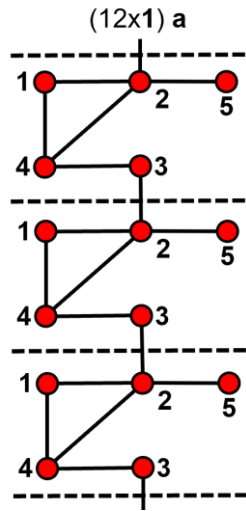

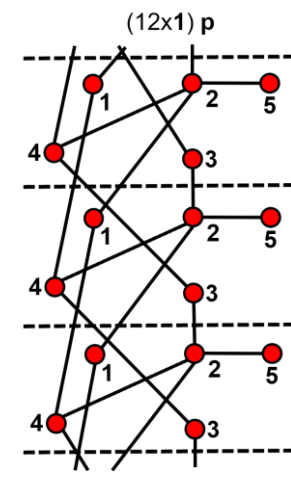
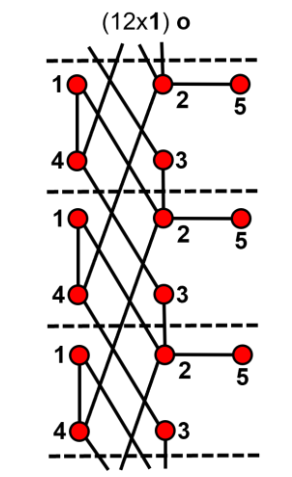
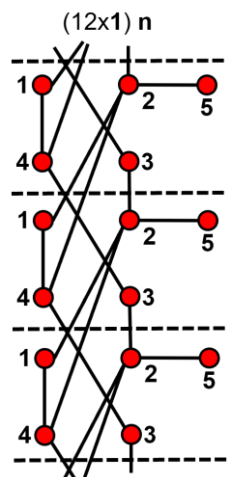
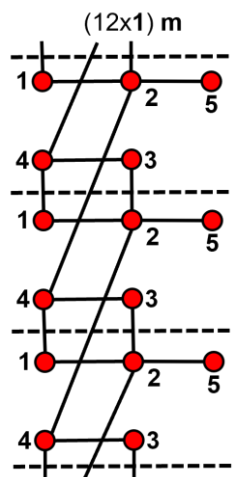
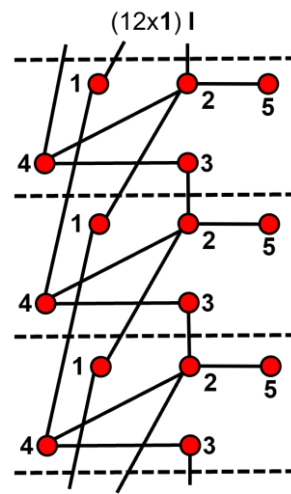
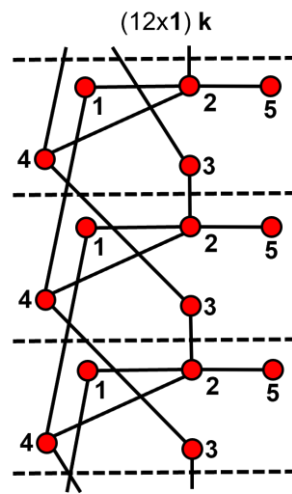
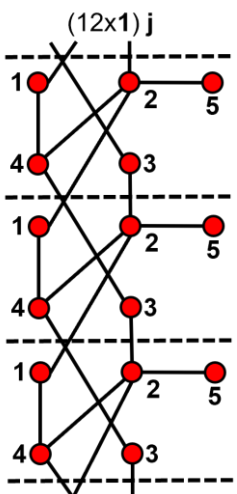
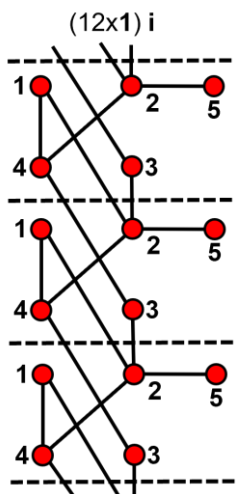

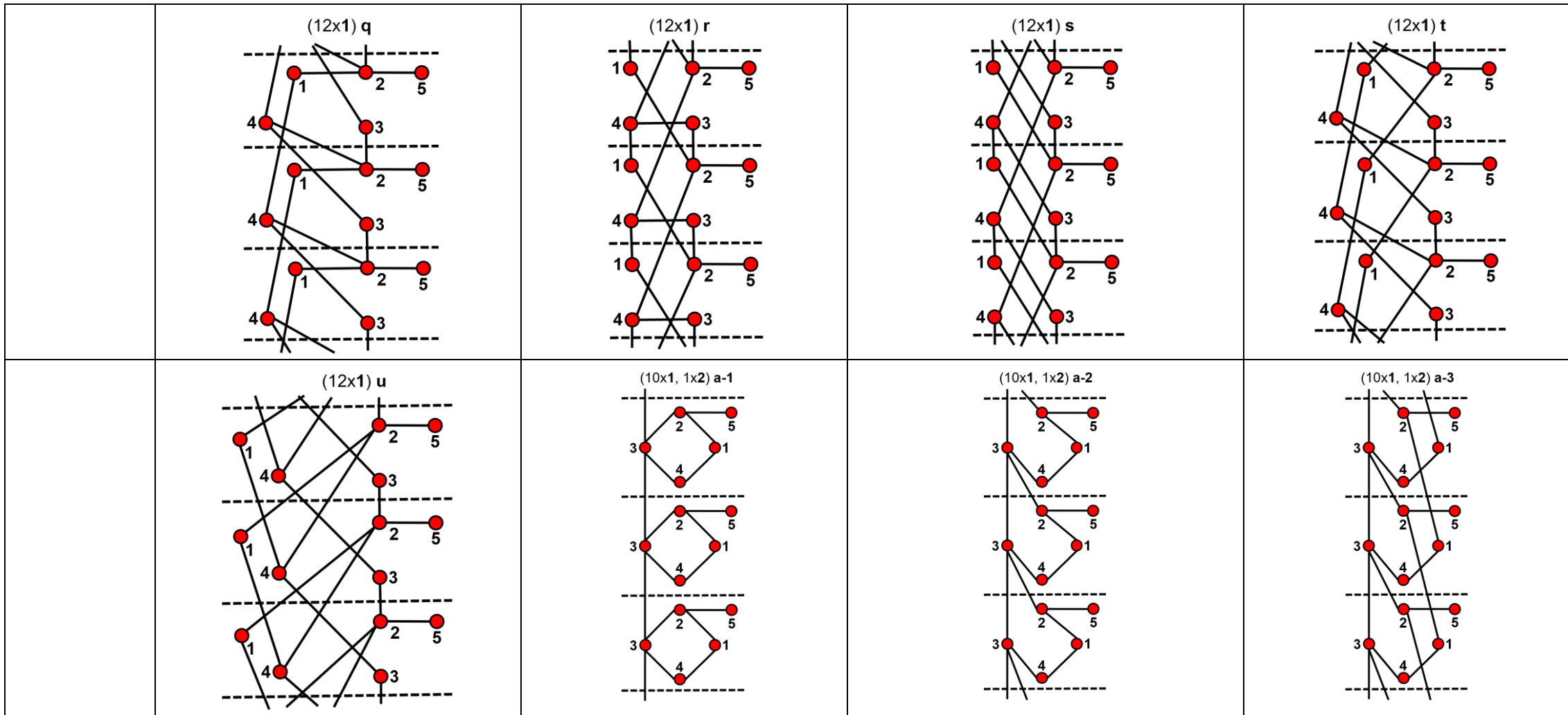

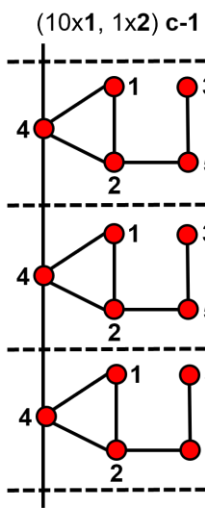
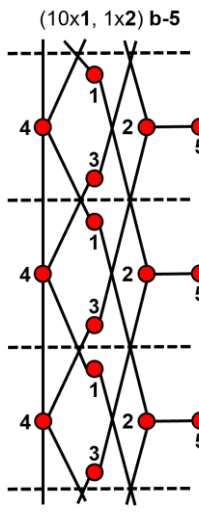
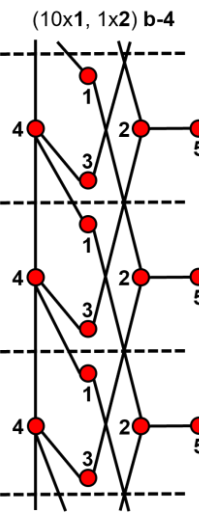
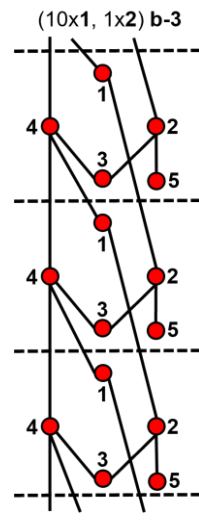
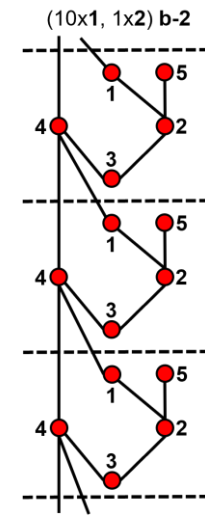
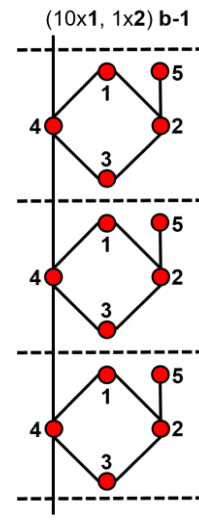
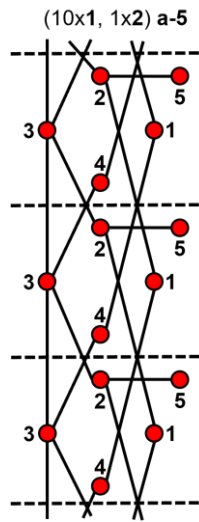
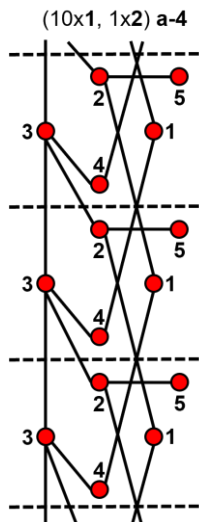

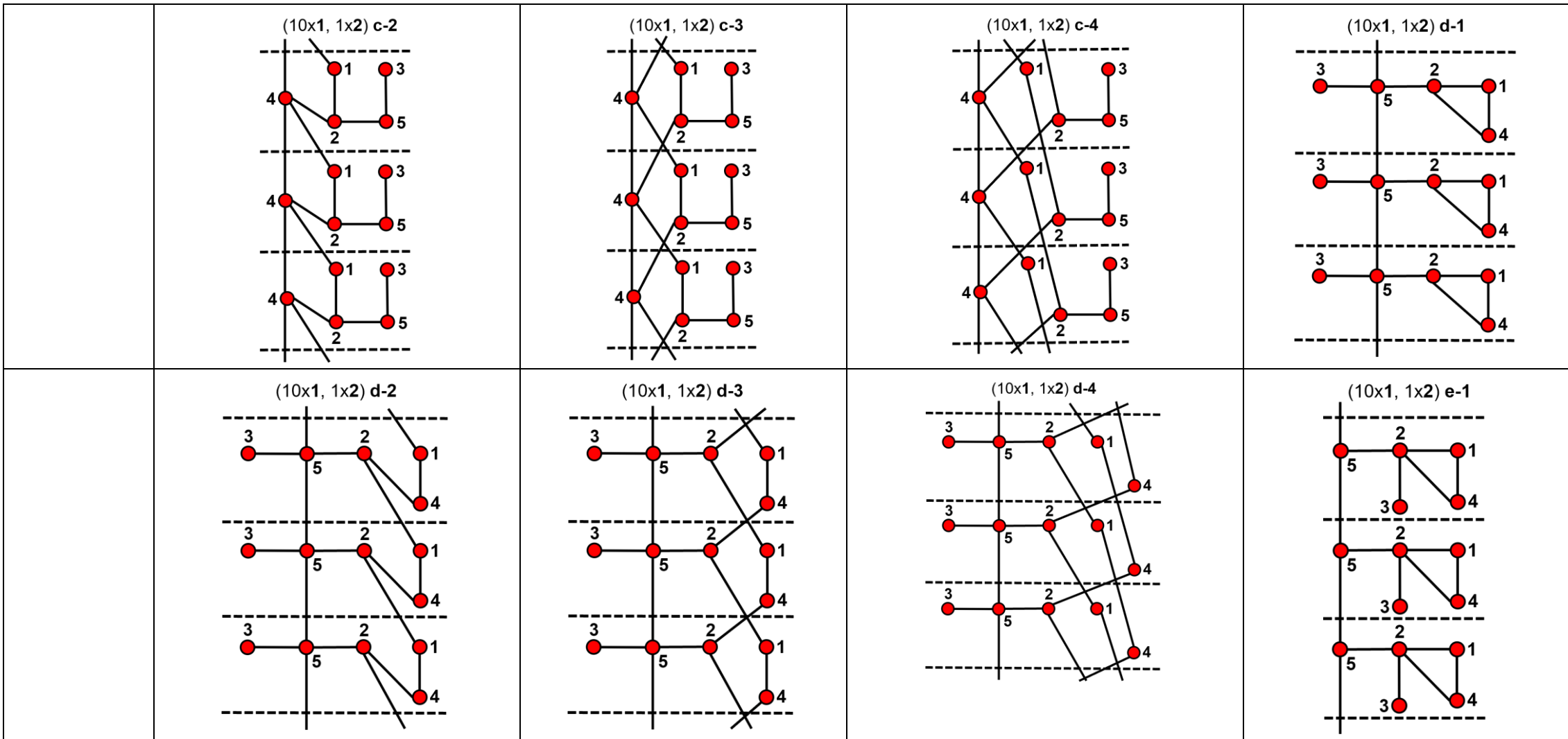



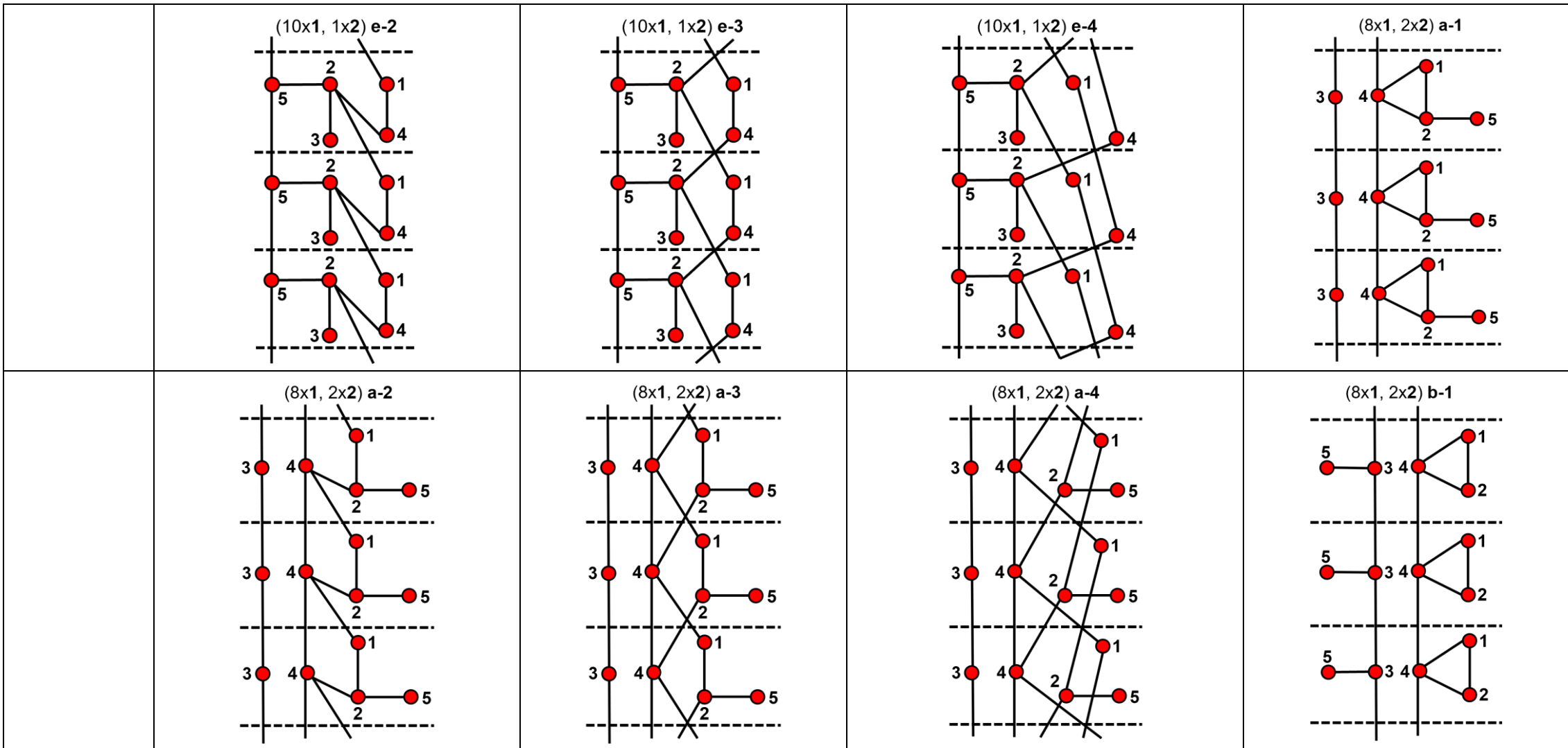

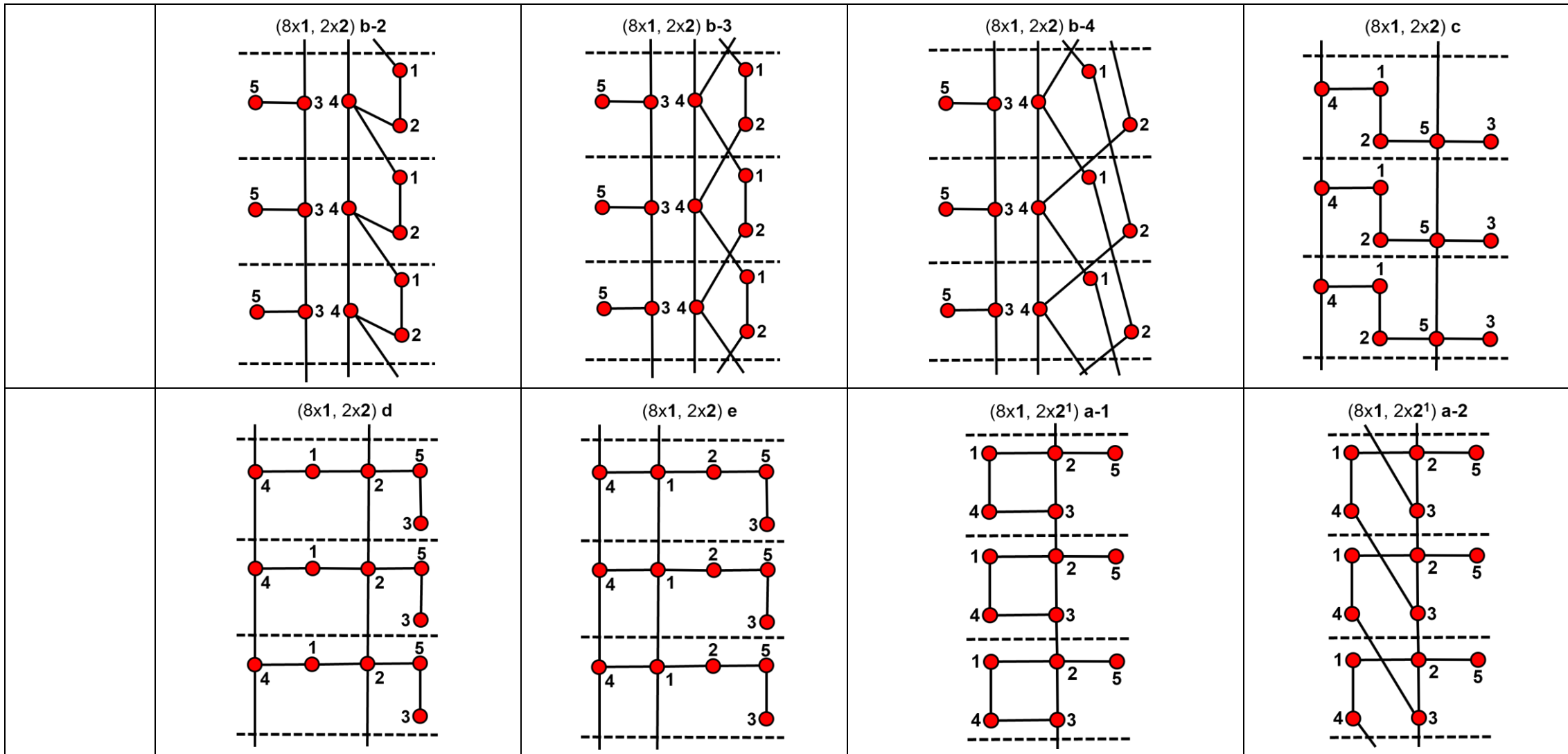

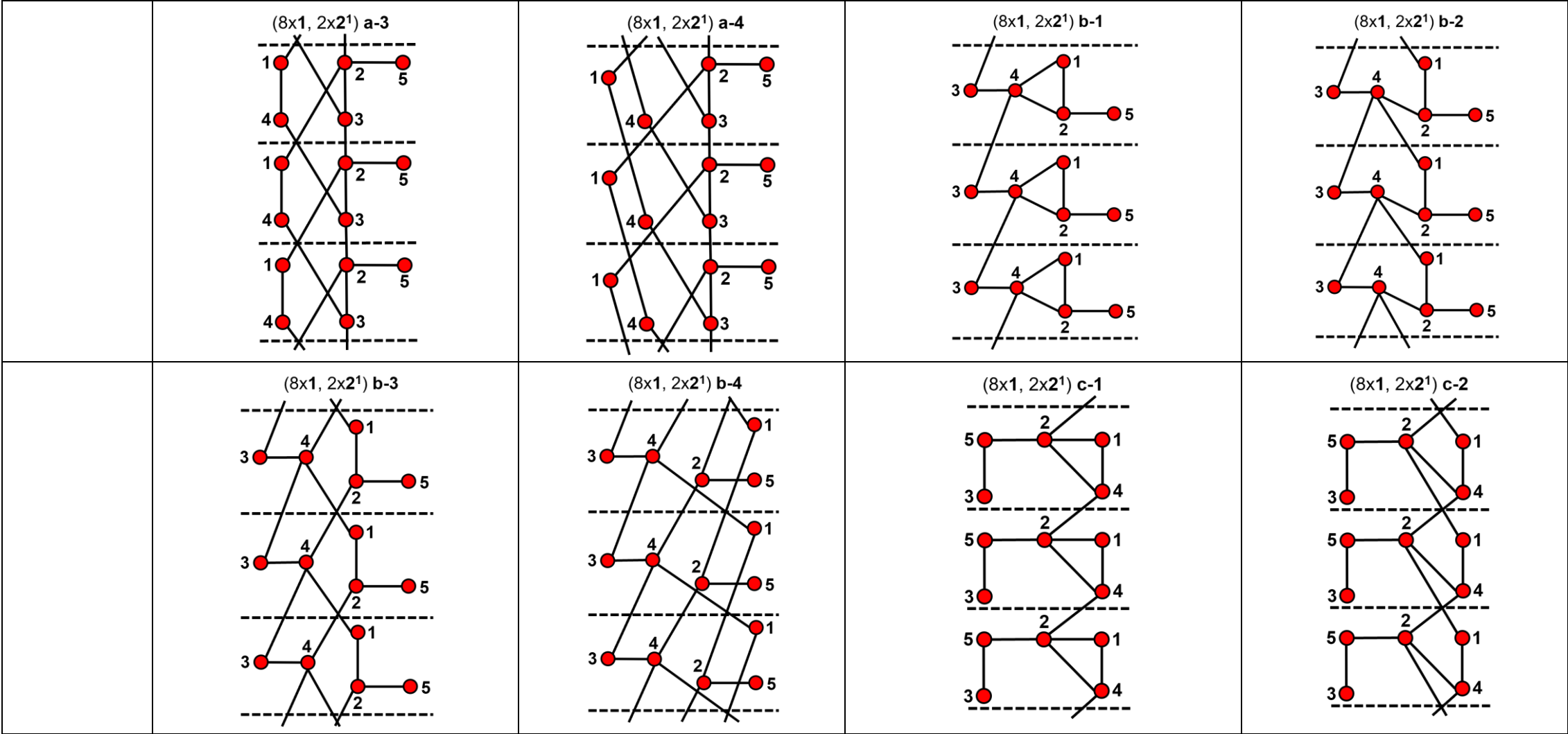

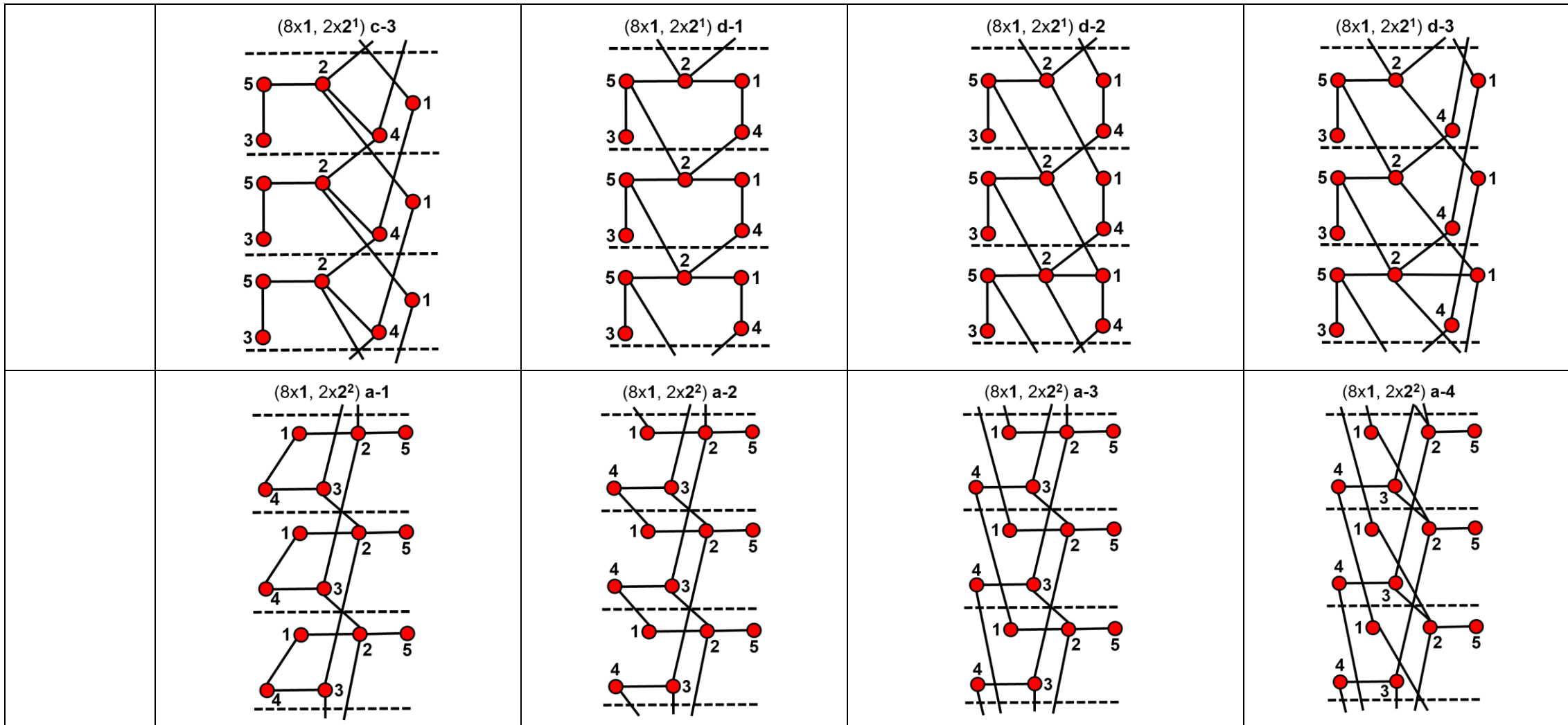

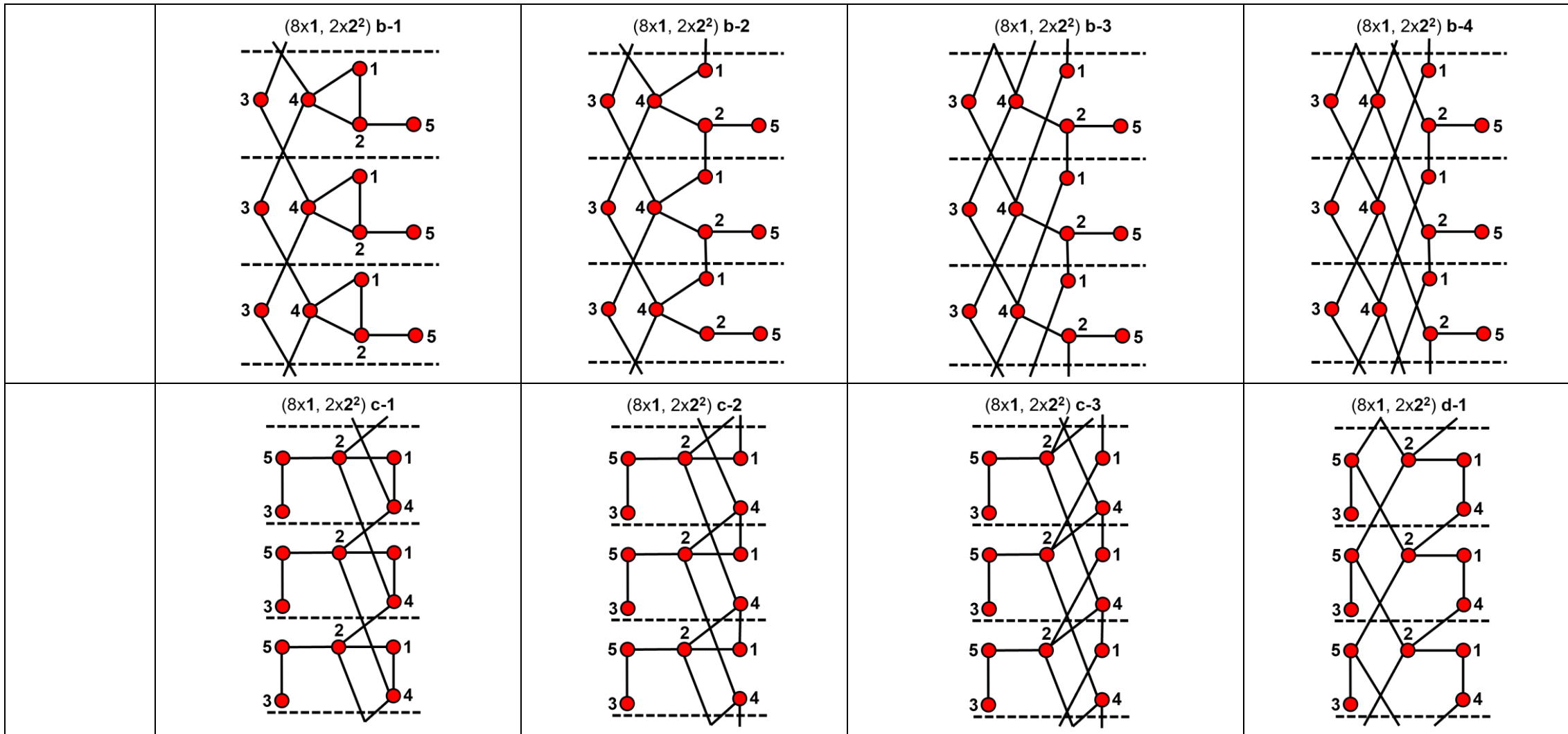

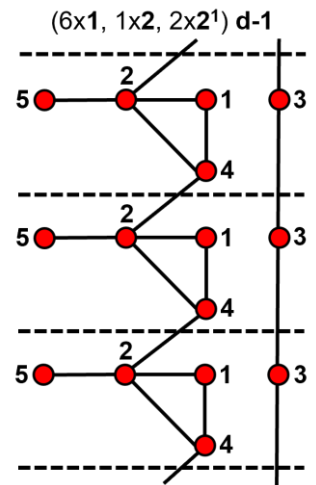
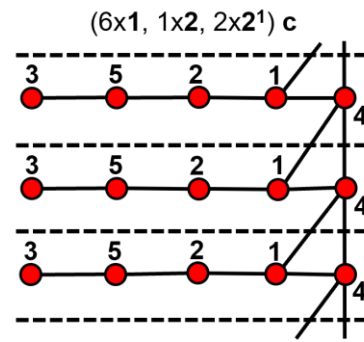
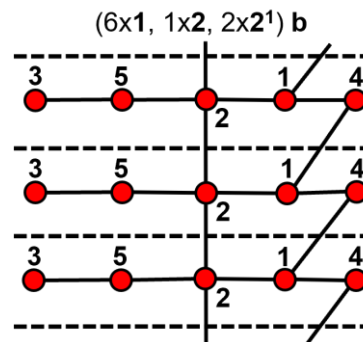
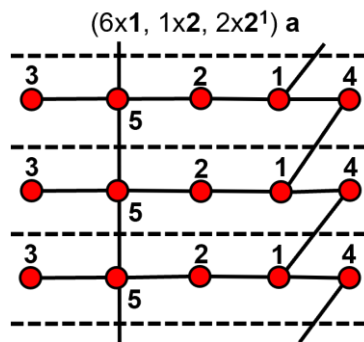
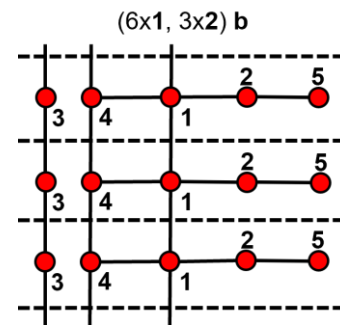
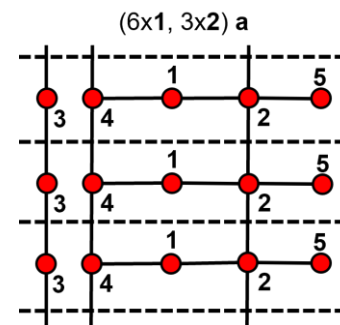
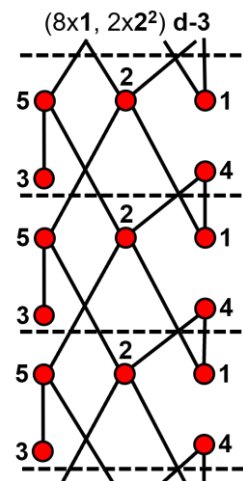
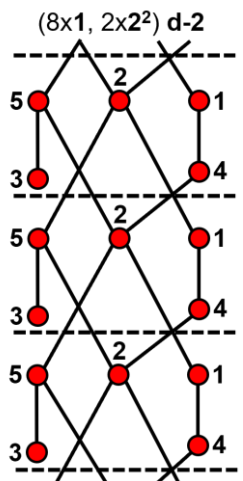

(6x1, 1x2, 2x2<sup>1</sup>) d-2

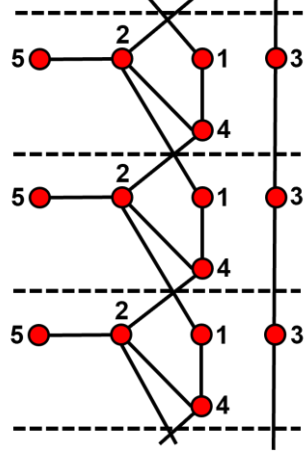

(6x1, 1x2, 2x2<sup>1</sup>) d-3

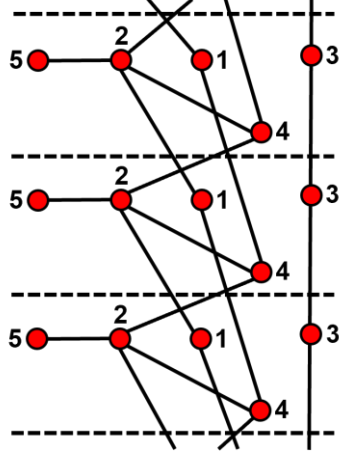

(6x1, 1x2, 2x2<sup>1</sup>) e

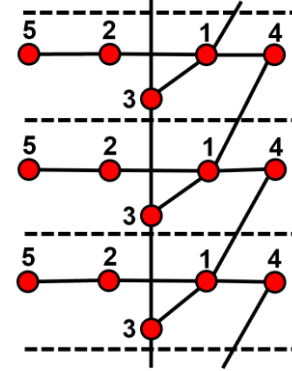

(6x1, 1x2, 2x2<sup>1</sup>) f

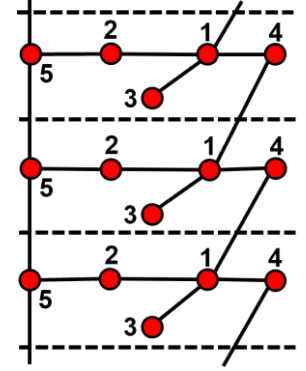

(6x1, 1x2, 2x2<sup>2</sup>) a

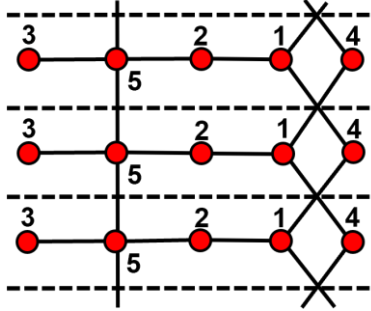

(6x1, 1x2, 2x2<sup>2</sup>) b

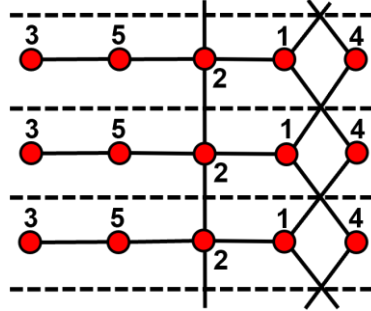

(6x1, 1x2, 2x2<sup>2</sup>) c

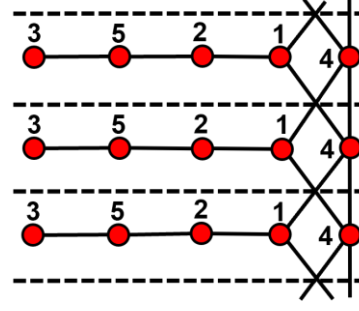

(6x1, 1x2, 2x2<sup>2</sup>) d-1

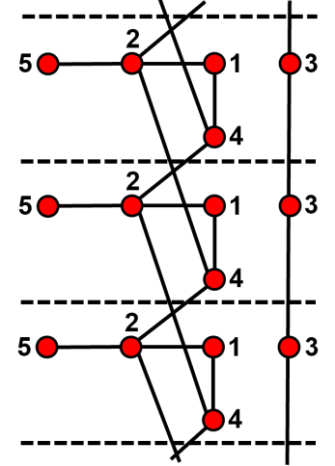

(6x1, 1x2, 2x2<sup>2</sup>) d-2

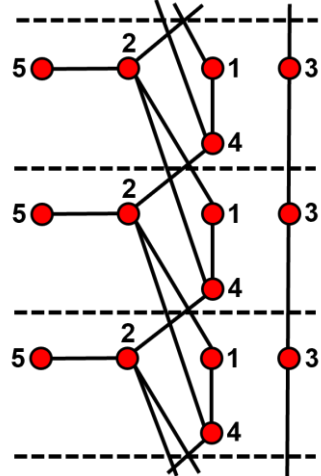

(6x1, 1x2, 2x2<sup>2</sup>) d-3

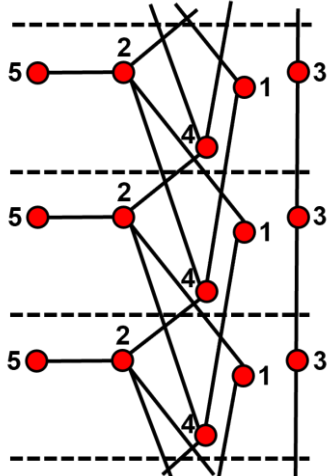

(6x1, 1x2, 2x2<sup>2</sup>) e

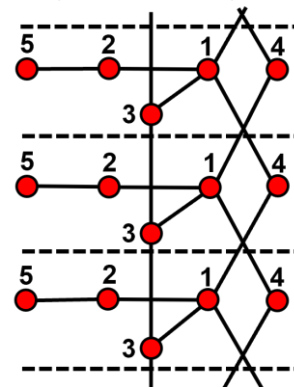

(6x1, 1x2, 2x2<sup>2</sup>) f

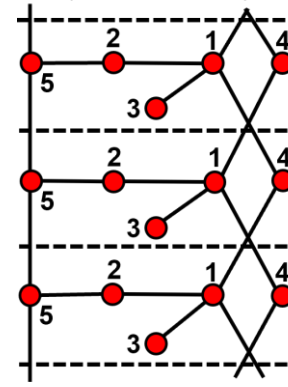

(4x1, 4x2)

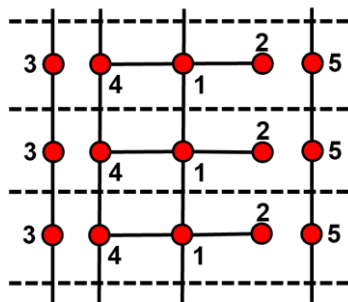

(4x1, 2x2, 2x2<sup>1</sup>) b

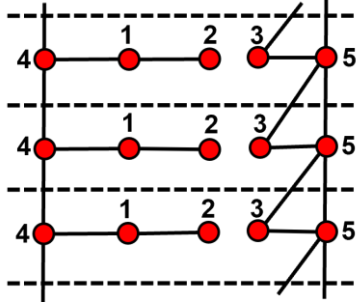

(4x1, 2x2, 2x2<sup>1</sup>) c

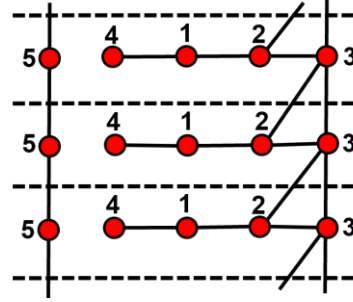

(4x1, 2x2, 2x2<sup>1</sup>) d

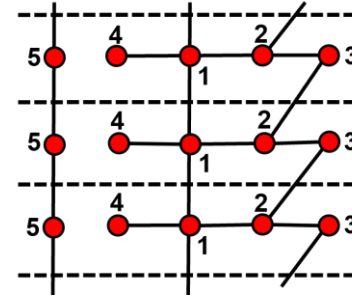



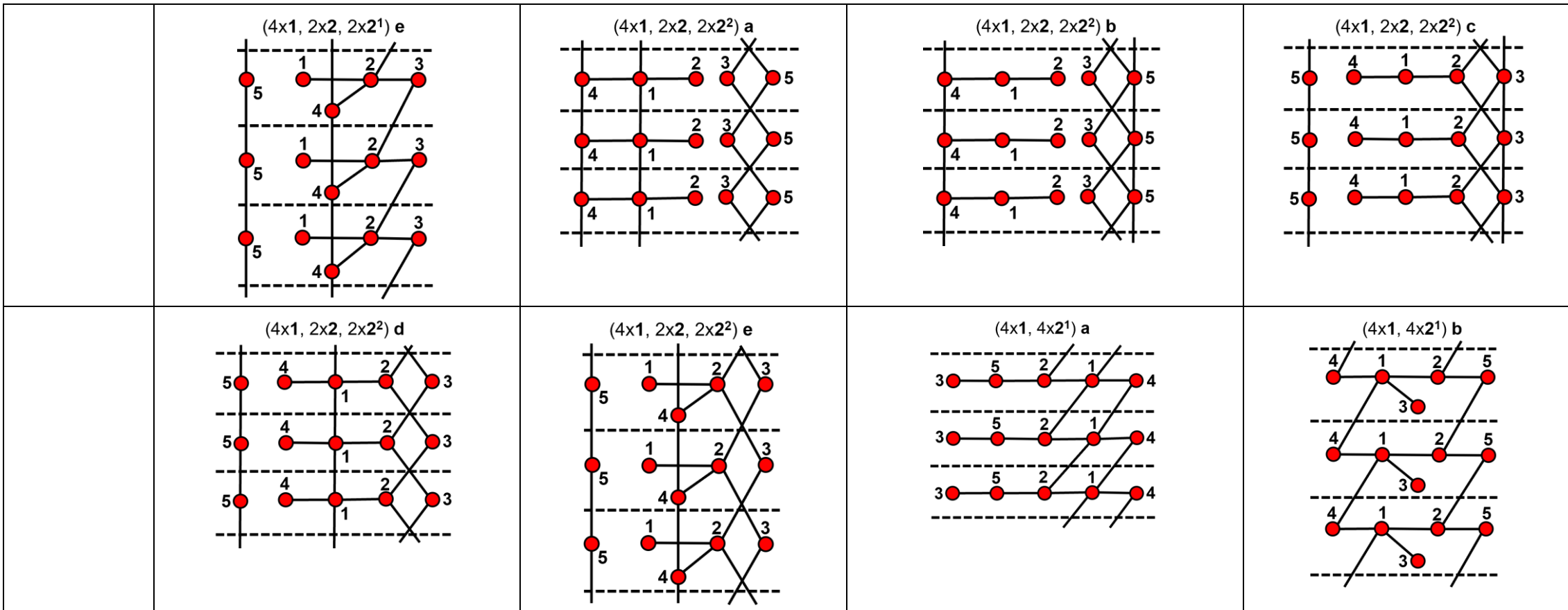

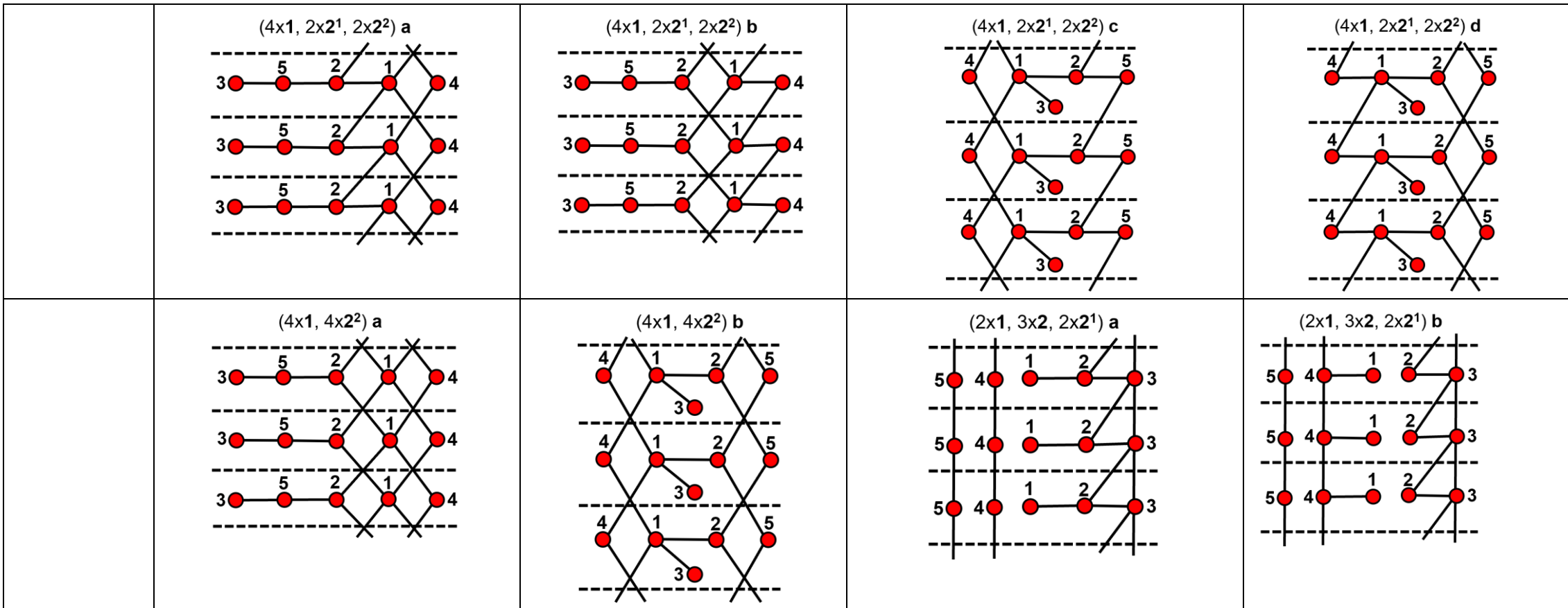

	<p>(2x1, 3x2, 2x2<sup>2</sup>) a</p>	<p>(2x1, 3x2, 2x2<sup>2</sup>) b</p>	<p>(2x1, 1x2, 4x2<sup>1</sup>) b</p>	<p>(2x1, 1x2, 4x2<sup>1</sup>) c</p>
	<p>(2x1, 1x2, 4x2<sup>1</sup>) d</p>	<p>(2x1, 1x2, 2x2<sup>1</sup>, 2x2<sup>2</sup>) b</p>	<p>(2x1, 1x2, 2x2<sup>1</sup>, 2x2<sup>2</sup>) c</p>	<p>(2x1, 1x2, 2x2<sup>1</sup>, 2x2<sup>2</sup>) d</p>
	<p>(2x1, 1x2, 2x2<sup>1</sup>, 2x2<sup>2</sup>) e</p>	<p>(2x1, 1x2, 2x2<sup>1</sup>, 2x2<sup>2</sup>) f</p>	<p>(2x1, 1x2, 2x2<sup>1</sup>, 2x2<sup>2</sup>) g</p>	<p>(2x1, 1x2, 4x2<sup>2</sup>) a</p>

	(2x1, 1x2, 4x2 <sup>2</sup> ) b	(2x1, 1x2, 4x2 <sup>2</sup> ) c	(2x1, 1x2, 4x2 <sup>2</sup> ) d	
${}^1V_1^2V_2^3V_1^4V_2$	NG			
${}^1V_1^2V_2^3V_1^4V_3$	NG			
${}^1V_1^2V_2^3V_1^4V_4$	NG			
${}^1V_1^2V_2^3V_3^4V_1$	NG			
${}^1V_1^2V_2^3V_3^4V_2$	NG			
${}^1V_1^2V_3^3V_1^4V_1$	NG			
${}^1V_1^2V_3^3V_1^4V_2$	NG			
${}^1V_1^2V_3^3V_1^4V_3$	NG			
${}^1V_1^2V_3^3V_3^4V_1$	NG			
${}^1V_1^2V_4^3V_1^4V_1$	NG			
${}^1V_1^2V_4^3V_1^4V_2$	NG			
${}^1V_1^2V_5^3V_1^4V_1$	NG			
${}^1V_2^2V_1^3V_2^4V_1$	NG			
${}^1V_2^2V_1^3V_2^4V_2$	NG			
${}^1V_2^2V_1^3V_2^4V_3$	NG			

${}^1V_2^2V_1^3V_4^4V_1$	NG			
${}^1V_2^2V_2^3V_2^4V_1$	NG			
${}^1V_2^2V_2^3V_2^4V_2$	NG			
${}^1V_2^2V_3^3V_2^4V_1$	NG			
${}^1V_3^2V_1^3V_1^4V_1$	NG			
${}^1V_3^2V_1^3V_1^4V_2$	NG			
${}^1V_3^2V_1^3V_1^4V_3$	NG			
${}^1V_3^2V_1^3V_3^4V_1$	NG			
${}^1V_3^2V_2^3V_1^4V_1$	NG			
${}^1V_3^2V_2^3V_1^4V_2$	NG			
${}^1V_3^2V_3^3V_1^4V_1$	NG			
${}^1V_4^2V_1^3V_2^4V_1$	NG			
${}^1V_5^2V_1^3V_1^4V_1$	NG			

Vertex connectivities ( ${}^eV_r$ ) where  $e_A$  is odd cannot form graphs and are not listed.

NG = chain graphs not generated.

NG