



FOUNDATIONS
ADVANCES

Volume 78 (2022)





Supporting information for article:

Bond topology of chain, ribbon and tube silicates. Part I. Graph-theory generation of infinite one-dimensional arrangements of $(TO_4)^{n-}$ tetrahedra

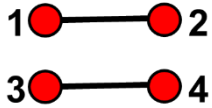
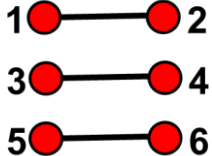
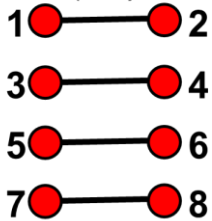
Maxwell Christopher Day and Frank Christopher Hawthorne

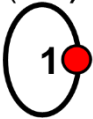
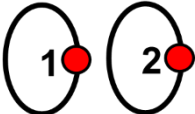
Appendix F. Matrix element combinations and associated non-isomorphic proto-graphs for vertex connectivities (cV_r) where $\sum r \leq 8$.

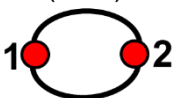
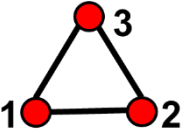
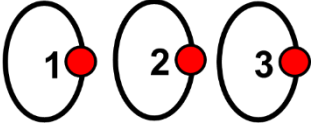
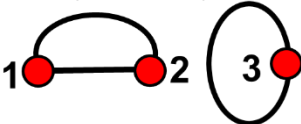
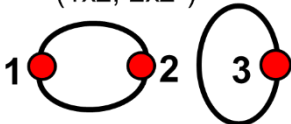
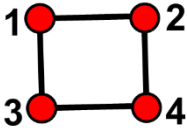
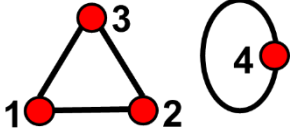
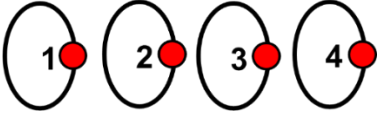
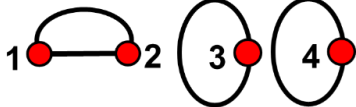
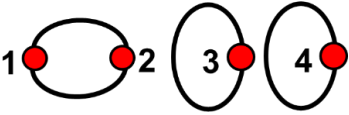
cV_r			
Rank 1			
${}^0V_{1-8}$	isolated tetrahedra (nesosilicates)		
1V_2	(2x1) 		
1V_4	(4x1) 		
1V_6	(6x1) 		
1V_8	(8x1) 		

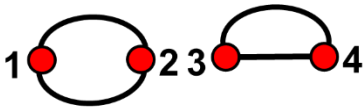
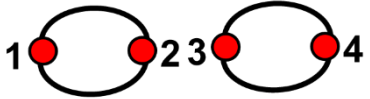
2V_1	(1x2) 			
2V_2	(2x2) 	(2x2^1) 	(2x2^2) 	
2V_3	(6x1) 	(3x2) 	(1x2, 2x2^1) 	(1x2, 2x2^2) 
2V_4	(8x1) 	(6x1, 1x2) 	(4x2) 	(2x2, 2x2^1) 
	(2x2, 2x2^2) 	(4x2^1) 	(2x2^1, 2x2^2) 	(4x2^2) 

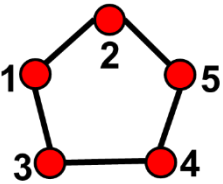
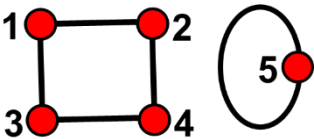
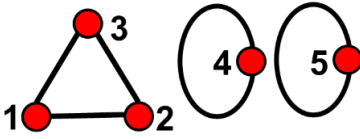
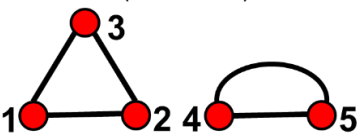
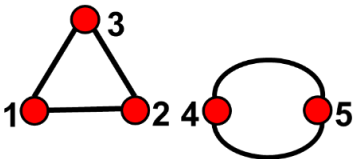
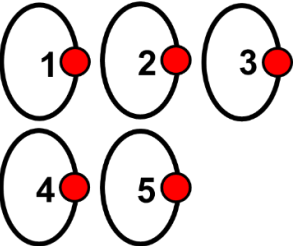
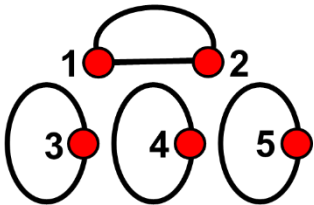
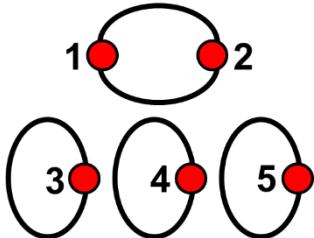
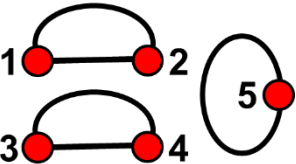
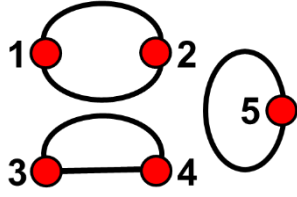
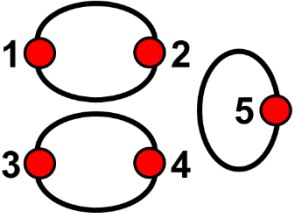
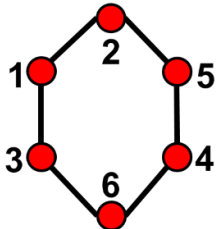
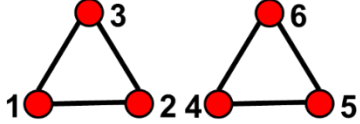
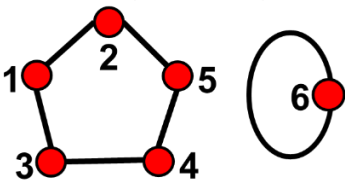
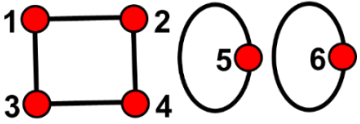
2V_5	<p>(10x1)</p> 	<p>(8x1, 1x2)</p> 	<p>(6x1, 2x2)</p> 	<p>(6x1, 2x2')</p> 
	<p>(6x1, 2x2²)</p> 	<p>(5x2)</p> 	<p>(3x2, 2x2')</p> 	<p>(3x2, 2x2²)</p> 
	<p>(1x2, 4x2')</p> 	<p>(1x2, 2x2', 2x2²)</p> 	<p>(1x2, 4x2²)</p> 	
2V_6	<p>(12x1) a</p> 	<p>(12x1) b</p> 	<p>(10x1, 1x2)</p> 	<p>(8x1, 2x2)</p> 

	<p>(8x1, 2x2¹)</p>	<p>(8x1, 2x2²)</p>	<p>(6x1, 3x2)</p>	<p>(6x1, 1x2, 2x2¹)</p>
	<p>(6x1, 1x2, 2x2²)</p>	<p>(6x2)</p>	<p>(4x2, 2x2¹)</p>	<p>(4x2, 2x2²)</p>
	<p>(2x2, 4x2¹)</p>	<p>(2x2, 2x2¹, 2x2²)</p>	<p>(2x2, 4x2²)</p>	<p>(6x2¹)</p>

	<p>($4 \times 2^1, 2 \times 2^2$)</p>	<p>($2 \times 2^1, 4 \times 2^2$)</p>	<p>(6×2^2)</p>	
2V_7	<p>(14×1) a</p>	<p>(14×1) b</p>	<p>($12 \times 1, 1 \times 2$) a</p>	<p>($12 \times 1, 1 \times 2$) b</p>
	<p>($10 \times 1, 2 \times 2$)</p>	<p>($10 \times 1, 2 \times 2^1$)</p>	<p>($10 \times 1, 2 \times 2^2$)</p>	<p>($8 \times 1, 3 \times 2$)</p>

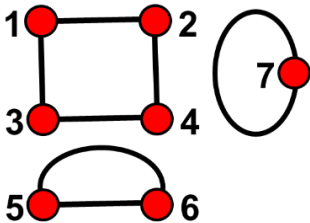
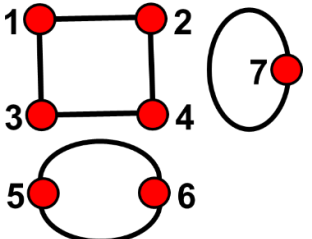
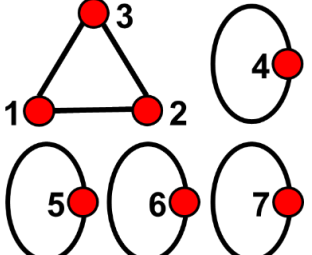
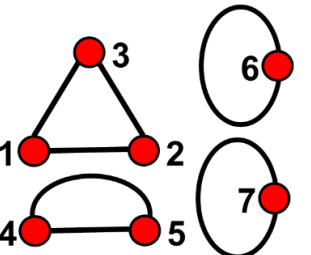
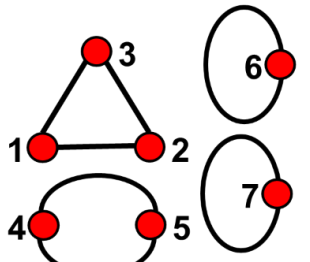
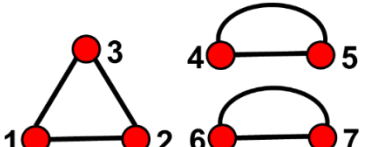
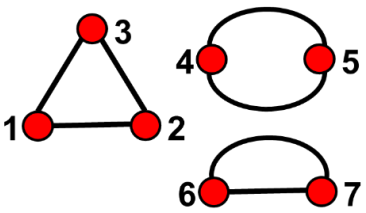
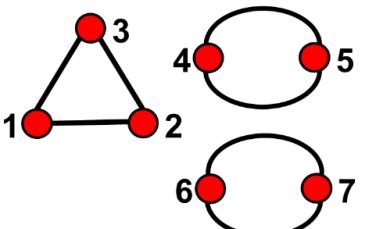
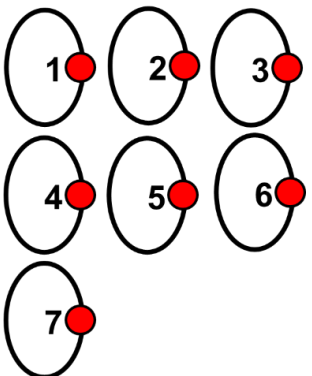
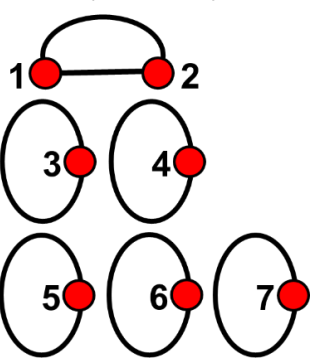
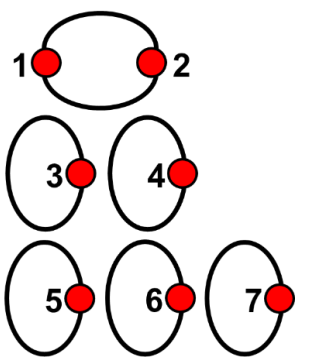
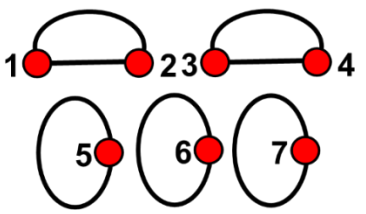
<p>(8x1, 1x2, 2x2¹)</p> 	<p>(8x1, 1x2, 2x2²)</p> 	<p>(6x1, 4x2)</p> 	<p>(6x1, 2x2, 2x2¹)</p> 
<p>(6x1, 2x2, 2x2²)</p> 	<p>(6x1, 4x2¹)</p> 	<p>(6x1, 2x2¹, 2x2²)</p> 	<p>(6x1, 4x2²)</p> 
<p>(7x2)</p> 	<p>(5x2, 2x2¹)</p> 	<p>(5x2, 2x2²)</p> 	<p>(3x2, 4x2¹)</p> 

	<p>(3x2, 2x2¹, 2x2²)</p>	<p>(3x2, 4x2²)</p>	<p>(1x2, 6x2¹)</p>	<p>(1x2, 4x2¹, 2x2²)</p>
	<p>(1x2, 2x2¹, 4x2²)</p>	<p>(1x2, 6x2²)</p>		
2V_8	<p>(16x1) a</p>	<p>(16x1) b</p>	<p>(16x1) c</p>	<p>(14x1, 1x2) a</p>

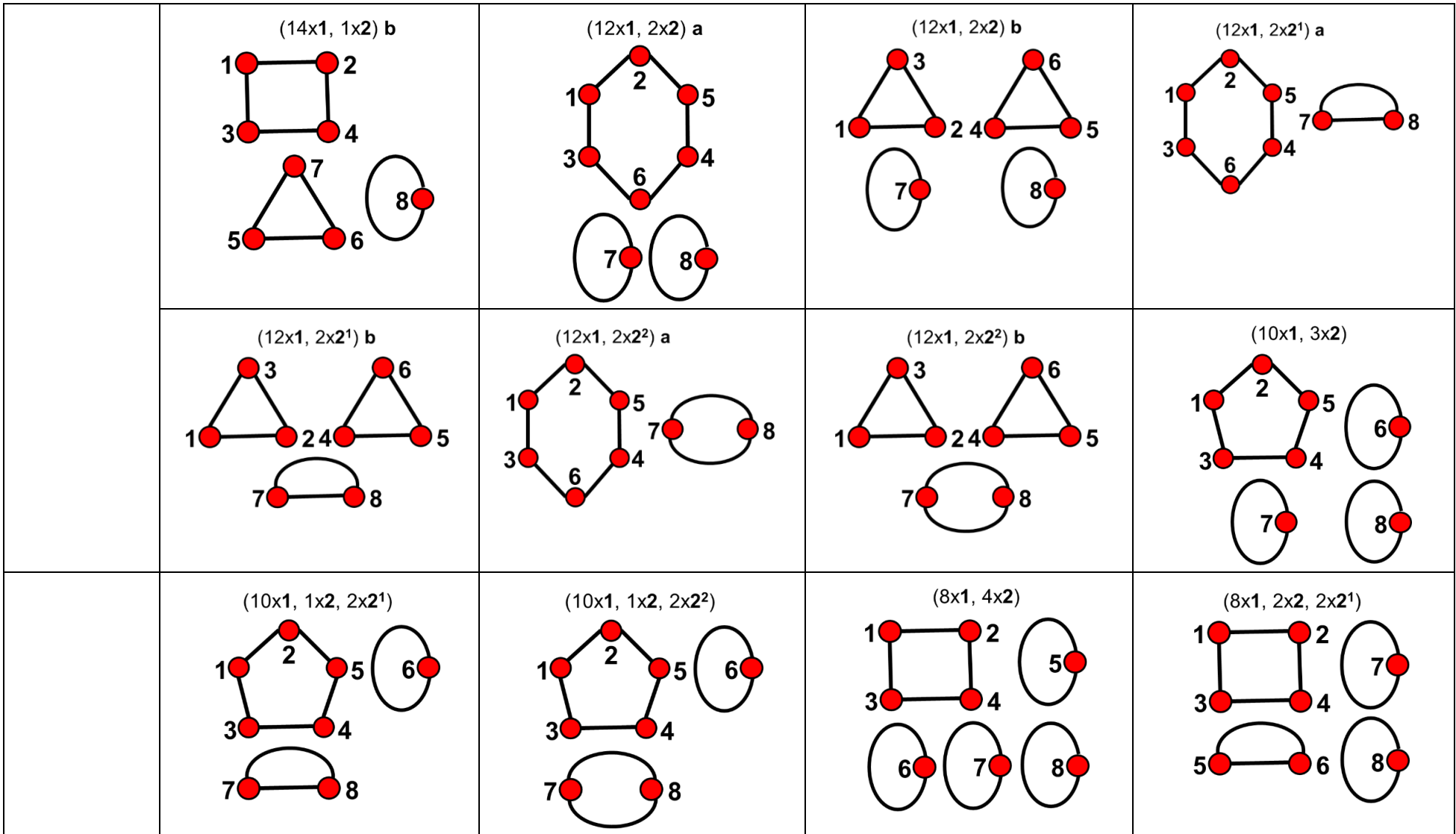

<p>(8x1, 2x2, 2x2²)</p>	<p>(8x1, 4x2¹)</p>	<p>(8x1, 2x2¹, 2x2²)</p>	<p>(8x1, 4x2²)</p>
<p>(6x1, 5x2)</p>	<p>(6x1, 3x2, 2x2¹)</p>	<p>(6x1, 3x2, 2x2²)</p>	<p>(6x1, 1x2, 4x2¹)</p>
<p>(6x1, 1x2, 2x2¹, 2x2²)</p>	<p>(6x1, 1x2, 4x2²)</p>	<p>(8x2)</p>	<p>(6x2, 2x2¹)</p>

<p>(6x2, 2x2²)</p>	<p>(4x2, 4x2¹)</p>	<p>(4x2, 2x2¹, 2x2²)</p>	<p>(4x2, 4x2²)</p>
<p>(2x2, 6x2¹)</p>	<p>(2x2, 4x2¹, 2x2²)</p>	<p>(2x2, 2x2¹, 4x2²)</p>	<p>(2x2, 6x2²)</p>
<p>(8x2¹)</p>	<p>(6x2¹, 2x2²)</p>	<p>(4x2¹, 4x2²)</p>	<p>(2x2¹, 6x2²)</p>
<p>(8x2²)</p>			

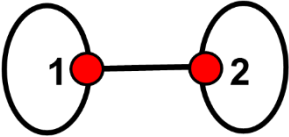
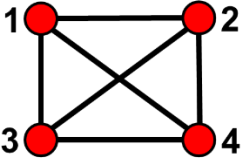
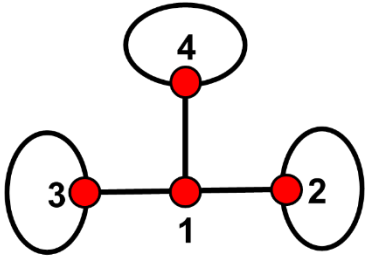
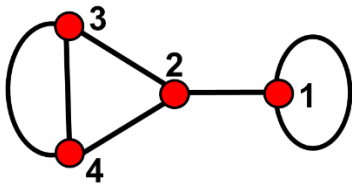
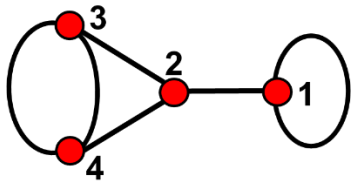
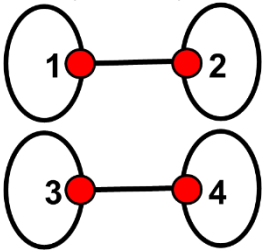
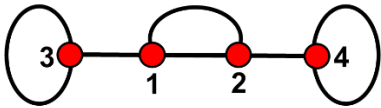
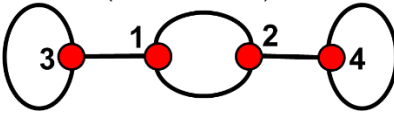
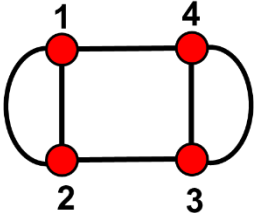
3V_2	<p>(2x1, 2x2)</p> 			
3V_4	<p>(12x1)</p> 	<p>(6x1, 3x2)</p> 	<p>(6x1, 1x2, 2x2¹)</p> 	<p>(6x1, 1x2, 2x2²)</p> 
	<p>(4x1, 4x2)</p> 	<p>(4x1, 2x2, 2x2¹)</p> 	<p>(4x1, 2x2, 2x2²)</p> 	<p>(4x1, 4x2¹)</p> 

	$(4 \times 1, 2 \times 2^1, 2 \times 2^2)$ 	$(4 \times 1, 4 \times 2^2)$ 		
3V_6				
3V_8				
4V_2	$(2 \times 2, 2 \times 2^1)$ 	$(2 \times 2, 2 \times 2^2)$ 		
4V_3	$(6 \times 1, 3 \times 2)$ 	$(2 \times 2, 4 \times 2^1)$ 	$(2 \times 2, 2 \times 2^1, 2 \times 2^2)$ 	$(2 \times 2, 4 \times 2^2)$

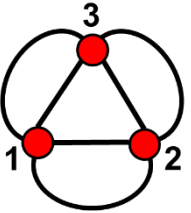
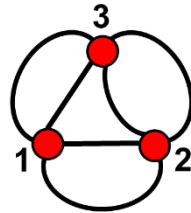
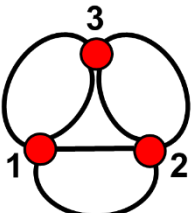
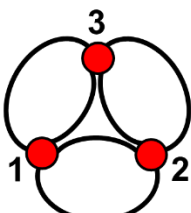
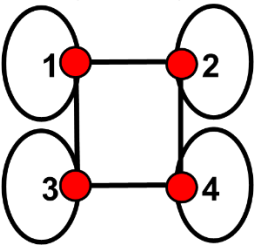
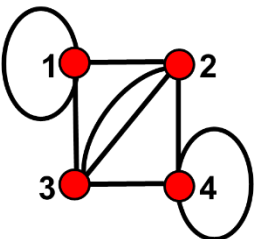
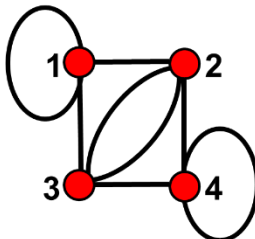
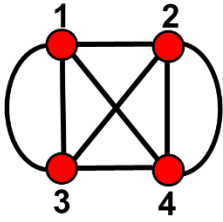
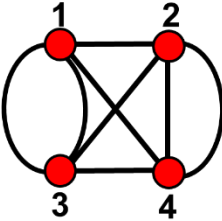
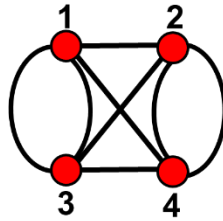
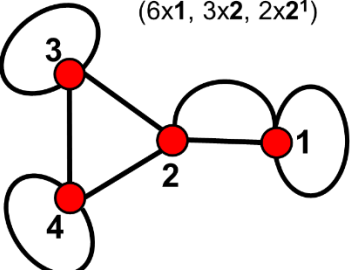
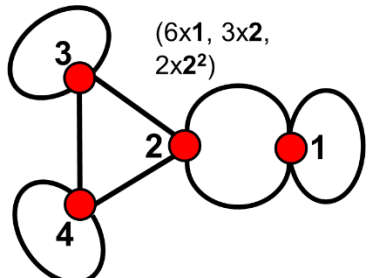
	$(6x2^1)$ 	$(4x2^1, 2x2^2)$ 	$(2x2^1, 4x2^2)$ 	$(6x2^2)$ 
4V_4	$(8x1, 4x2)$ 	$(8x1, 2x2, 2x2^1)$ 	$(8x1, 2x2, 2x2^2)$ 	$(8x1, 4x2^1)$ 
	$(8x1, 2x2^1, 2x2^2)$ 	$(8x1, 4x2^2)$ 	$(6x1, 3x2, 2x2^1)$ 	$(6x1, 3x2, 2x2^2)$ 

<p>(6x1, 1x2, 4x2¹)</p>	<p>(6x1, 1x2, 2x2¹, 2x2²)</p>	<p>(6x1, 1x2, 4x2²)</p>	<p>(4x2, 4x2¹)</p>
<p>(4x2, 2x2¹, 2x2²)</p>	<p>(4x2, 4x2²)</p>	<p>(2x2, 6x2¹)</p>	<p>(2x2, 4x2¹, 2x2²) a</p>
<p>(2x2, 4x2¹, 2x2²) b</p>	<p>(2x2, 2x2¹, 4x2²) a</p>	<p>(2x2, 2x2¹, 4x2²) b</p>	<p>(2x2, 6x2²)</p>

	<p>(8x2¹)</p>	<p>(6x2¹, 2x2²)</p>	<p>(4x2¹, 4x2²) a</p>	<p>(4x2¹, 4x2²) b</p>
	<p>(2x2¹, 6x2²)</p>	<p>(8x2²)</p>		
⁴ V ₅	NG			
⁴ V ₆	NG			
⁴ V ₇	NG			
⁴ V ₈	NG			
Rank 2				
¹ V ₂ ² V ₁	<p>(4x1)</p>	<p>(2x1, 1x2)</p>		

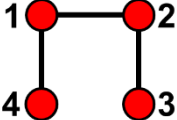
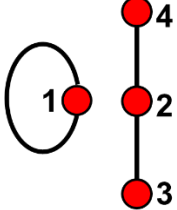
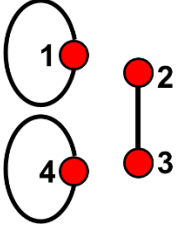
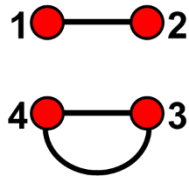
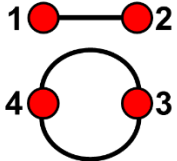
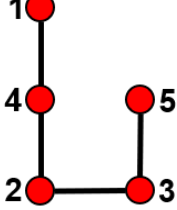
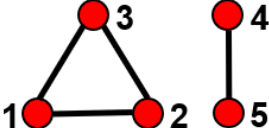
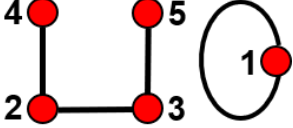
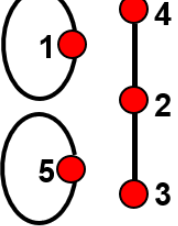
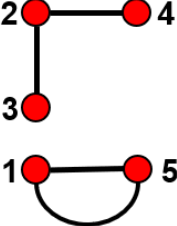
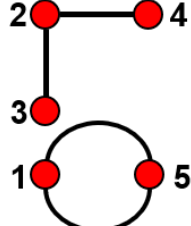
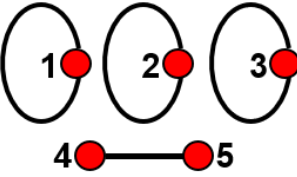
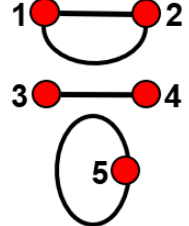
${}^1V_2^2V_2$	<p>(6x1)</p> 	<p>(4x1, 1x2)</p> 	<p>(2x1, 2x2)</p> 	<p>(2x1, 2x2')</p> 
	<p>(2x1, 2x2')</p> 			
${}^1V_2^2V_3$	<p>(8x1) a</p> 	<p>(8x1) b</p> 	<p>(6x1, 1x2)</p> 	<p>(4x1, 2x2)</p> 
	<p>(4x1, 2x2')</p> 	<p>(4x1, 2x2')</p> 	<p>(2x1, 3x2)</p> 	<p>(2x1, 1x2, 2x2')</p> 

	<p>(2x1, 1x2, 2x2²)</p>			
${}^1V_2{}^2V_4$	<p>(10x1) a</p>	<p>(10x1) b</p>	<p>(10x1) c</p>	<p>(8x1, 1x2) a</p>
	<p>(8x1, 1x2) b</p>	<p>(6x1, 2x2)</p>	<p>(6x1, 2x2¹)</p>	<p>(6x1, 2x2²)</p>
	<p>(4x1, 3x2)</p>	<p>(4x1, 1x2, 2x2¹)</p>	<p>(4x1, 1x2, 2x2²)</p>	<p>(2x1, 4x2)</p>

	<p>(2x1, 2x2, 2x2¹)</p>	<p>(2x1, 2x2, 2x2²)</p>	<p>(2x1, 4x2¹)</p>	<p>(2x1, 2x2¹, 2x2²)</p>
	<p>(2x1, 4x2²)</p>			
${}^1V_2^2V_5$	<p>(12x1) a</p>	<p>(12x1) b</p>	<p>(12x1) c</p>	<p>(12x1) d</p>
	<p>(10x1, 1x2) a</p>	<p>(10x1, 1x2) b</p>	<p>(10x1, 1x2) c</p>	<p>(8x1, 2x2) a</p>

	<p>(8x1, 2x2) b</p>	<p>(8x1, 2x2¹) a</p>	<p>(8x1, 2x2¹) b</p>	<p>(8x1, 2x2²) a</p>
	<p>(8x1, 2x2²) b</p>	<p>(6x1, 3x2)</p>	<p>(6x1, 1x2, 2x2¹)</p>	<p>(6x1, 1x2, 2x2²)</p>
	<p>(4x1, 4x2)</p>	<p>(4x1, 2x2, 2x2¹)</p>	<p>(4x1, 2x2, 2x2²)</p>	<p>(4x1, 4x2¹)</p>
	<p>(4x1, 2x2¹, 2x2²)</p>	<p>(4x1, 4x2²)</p>	<p>(2x1, 5x2)</p>	<p>(2x1, 3x2, 2x2¹)</p>

	<p>(2x1, 3x2, 2x2²)</p>	<p>(2x1, 1x2, 4x2¹)</p>	<p>(2x1, 1x2, 2x2¹, 2x2²)</p>	<p>(2x1, 1x2, 4x2²)</p>
${}^1V_2^2V_6$	NG			
${}^1V_4^2V_1$	<p>(6x1)</p>	<p>(4x1, 1x2)</p>		
${}^1V_4^2V_2$	<p>(8x1) a</p>	<p>(8x1) b</p>	<p>(6x1, 1x2)</p>	<p>(4x1, 2x2)</p>
	<p>(4x1, 2x2¹)</p>	<p>(4x1, 2x2²)</p>		

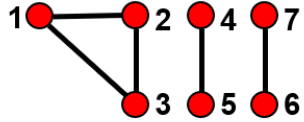
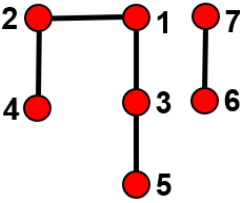
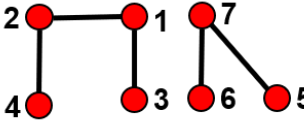
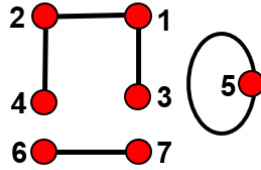
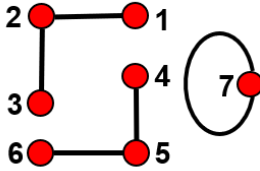
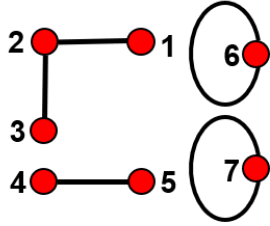
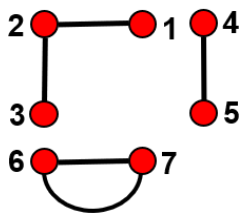
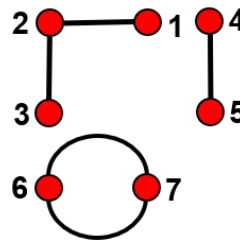
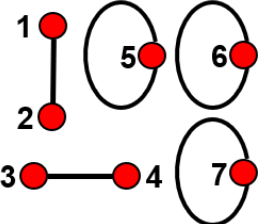
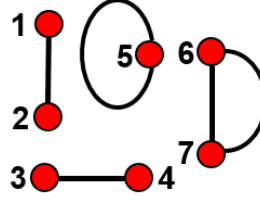
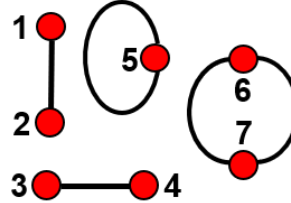
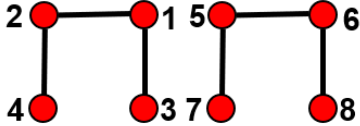
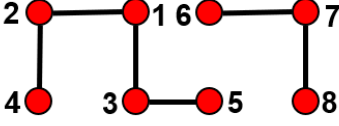
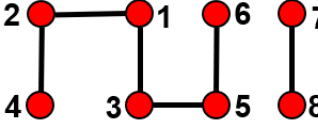
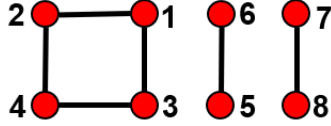
${}^1V_4^2V_3$	<p>(10x1) a</p> 	<p>(10x1) b</p> 	<p>(10x1) c</p> 	<p>(8x1, 1x2) a</p> 
	<p>(8x1, 1x2) b</p> 	<p>(6x1, 2x2)</p> 	<p>(6x1, 2x2¹)</p> 	<p>(6x1, 2x2²)</p> 
	<p>(4x1, 3x2)</p> 	<p>(4x1, 1x2, 2x2¹)</p> 	<p>(4x1, 1x2, 2x2²)</p> 	
${}^1V_4^2V_4$	<p>(12x1) a</p> 	<p>(12x1) b</p> 	<p>(12x1) c</p> 	<p>(12x1) d</p> 

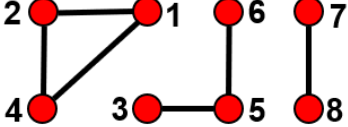
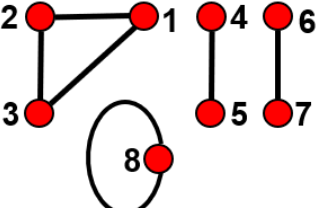
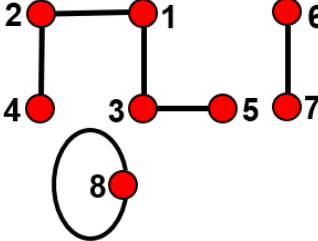
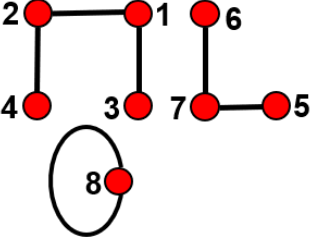
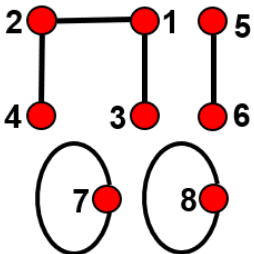
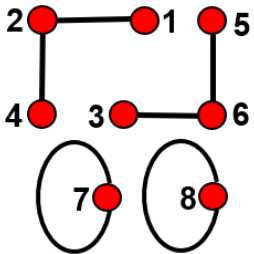
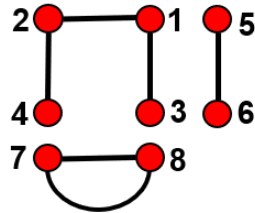
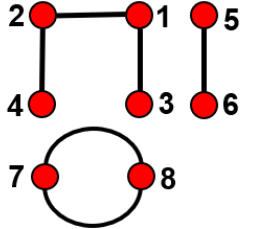
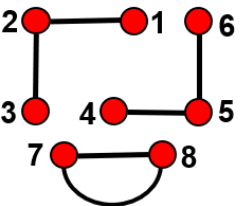
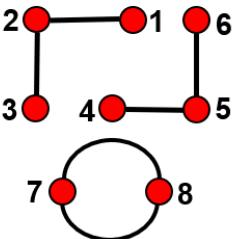
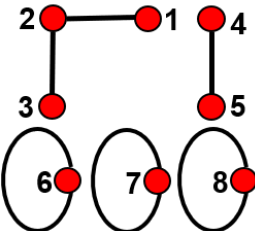
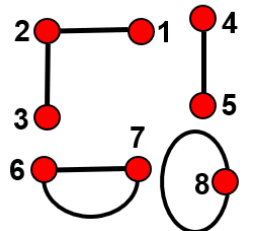
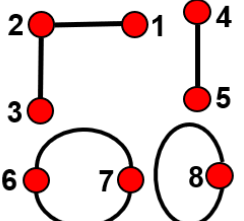
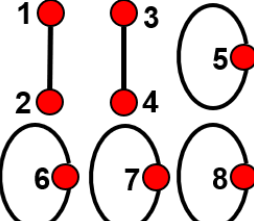
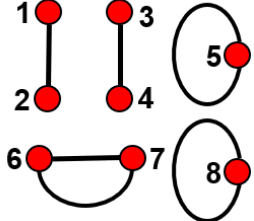
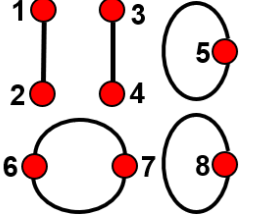
	<p>(12x1) e</p> 	<p>(10x1, 1x2) a</p> 	<p>(10x1, 1x2) b</p> 	<p>(10x1, 1x2) c</p> 
	<p>(8x1, 2x2) a</p> 	<p>(8x1, 2x2) b</p> 	<p>(8x1, 2x2^1) a</p> 	<p>(8x1, 2x2^2) a</p> 
	<p>(8x1, 2x2^1) b</p> 	<p>(8x1, 2x2^2) b</p> 	<p>(6x1, 3x2)</p> 	<p>(6x1, 1x2, 2x2^1)</p> 
	<p>(6x1, 1x2, 2x2^2)</p> 	<p>(4x1, 4x2)</p> 	<p>(4x1, 2x2, 2x2^1)</p> 	<p>(4x1, 2x2, 2x2^2)</p> 

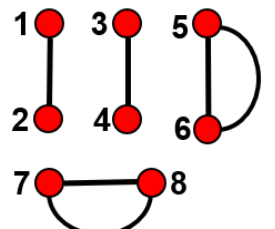
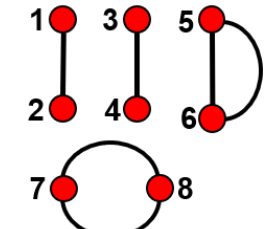
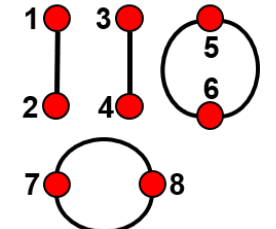
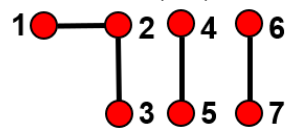
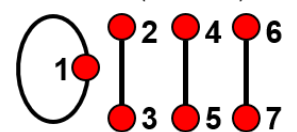
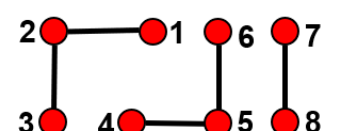
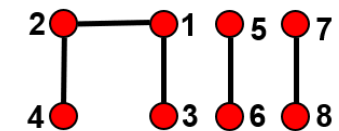
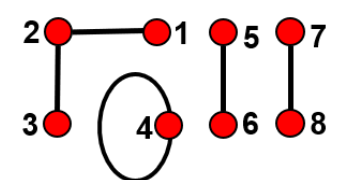
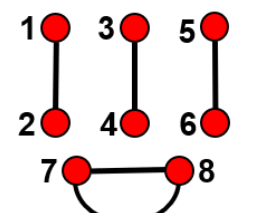
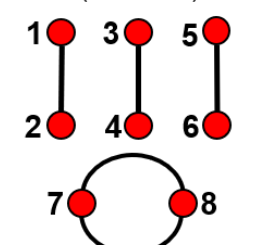
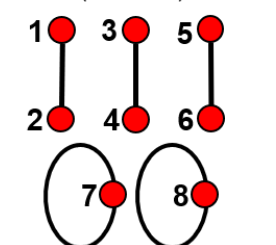
	<p>(4x1, 4x2¹)</p> 	<p>(4x1, 2x2¹, 2x2²)</p> 	<p>(4x1, 4x2²)</p> 	
${}^1V_6^2V_1$	<p>(8x1)</p> 	<p>(6x1, 1x2)</p> 		
${}^1V_6^2V_2$	<p>(10x1) a</p> 	<p>(10x1) b</p> 	<p>(8x1, 1x2)</p> 	<p>(6x1, 2x2¹)</p> 
	<p>(6x1, 2x2²)</p> 	<p>(6x1, 2x2)</p> 		
${}^1V_r^3V_r$				

${}^1V_1^3V_1$	(2x1, 1x2) 			
${}^1V_1^3V_3$	(6x1, 2x2) 	(6x1, 2x2^1) 	(6x1, 2x2^2) 	(4x1, 3x2)
	(4x1, 1x2, 2x2^1) 	(4x1, 1x2, 2x2^2) 		
${}^1V_1^3V_5$	(16x1) 	(14x1, 1x2) a 	(14x1, 1x2) b 	(12x1, 2x2)
	(12x1, 2x2^1) 	(12x1, 2x2^2) 	(10x1, 3x2) 	(10x1, 1x2, 2x2^1) a

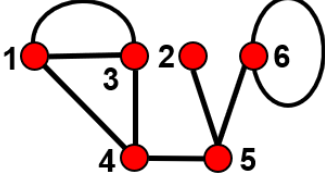
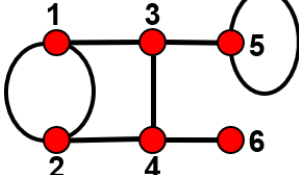
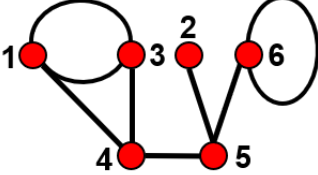
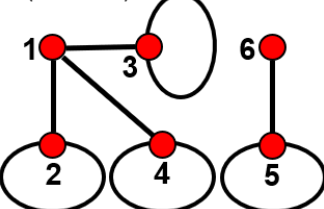
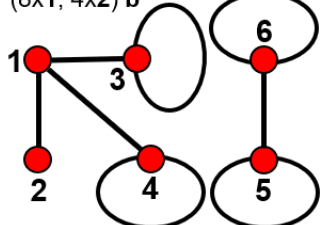
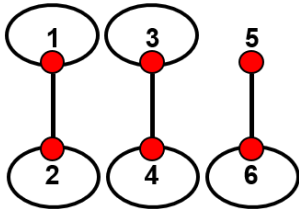
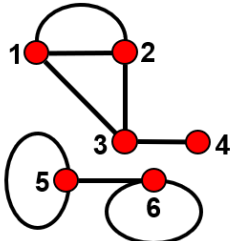
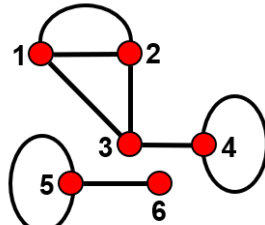
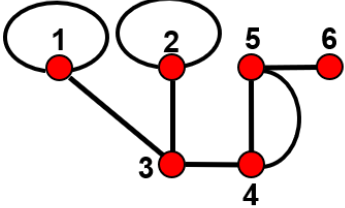
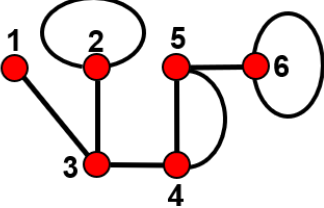
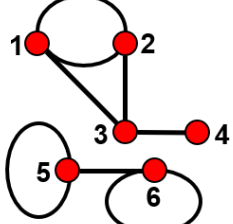
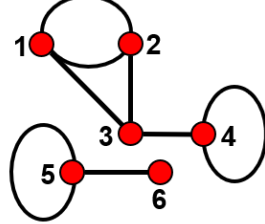
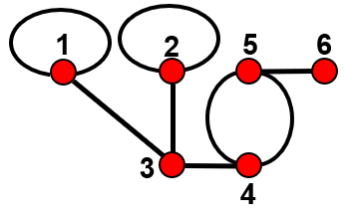
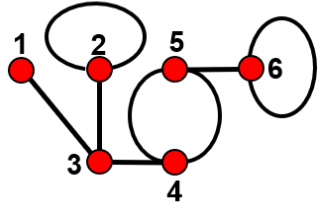
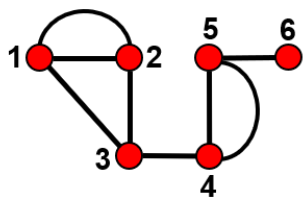
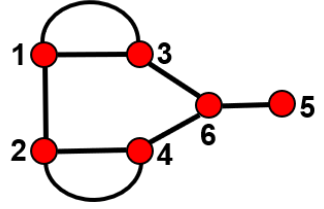
	<p>(10x1, 1x2, 2x2¹) b</p> 	<p>(10x1, 1x2, 2x2²) a</p> 	<p>(10x1, 1x2, 2x2²) b</p> 	<p>(8x1, 4x2) a</p> 
	<p>(8x1, 4x2) b</p> 	<p>(8x1, 4x2) c</p> 	<p>(8x1, 2x2, 2x2¹) a</p> 	<p>(8x1, 2x2, 2x2¹) b</p> 
	<p>(8x1, 2x2, 2x2¹) c</p> 	<p>(8x1, 2x2, 2x2¹) d</p> 	<p>(8x1, 2x2, 2x2²) a</p> 	<p>(8x1, 2x2, 2x2²) b</p> 
	<p>(8x1, 2x2, 2x2²) c</p> 	<p>(8x1, 2x2, 2x2²) d</p> 	<p>(8x1, 4x2¹) a</p> 	<p>(8x1, 4x2¹) b</p> 

	(8x1, 2x2 ¹ , 2x2 ²) a 	(8x1, 2x2 ¹ , 2x2 ²) b 	(8x1, 2x2 ¹ , 2x2 ²) c 	(8x1, 4x2 ²) a
	(8x1, 4x2 ²) b 	(6x1, 3x2, 2x2 ¹) a 	(6x1, 3x2, 2x2 ¹) b 	(6x1, 3x2, 2x2 ²) a
	(6x1, 3x2, 2x2 ²) b 	(6x1, 1x2, 4x2 ¹) a 	(6x1, 1x2, 4x2 ¹) b 	(6x1, 1x2, 2x2 ¹ , 2x2 ²) a
	(6x1, 1x2, 2x2 ¹ , 2x2 ²) b 	(6x1, 1x2, 2x2 ¹ , 2x2 ²) c 	(6x1, 1x2, 4x2 ²) a 	(6x1, 1x2, 4x2 ²) b
¹ V _i ³ V ₇	NG			

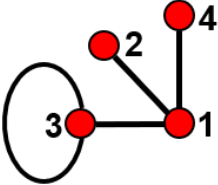
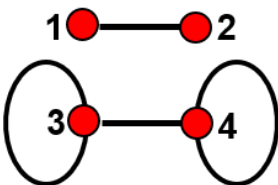
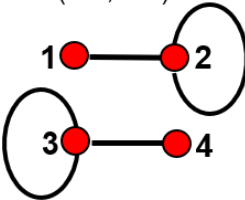
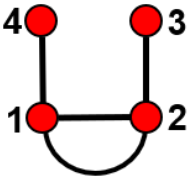
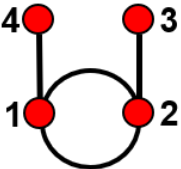
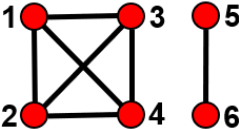
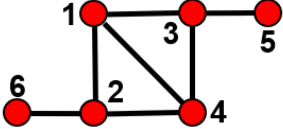
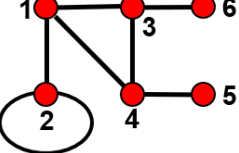
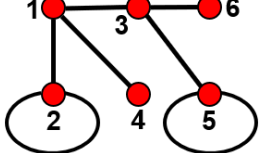
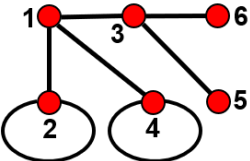
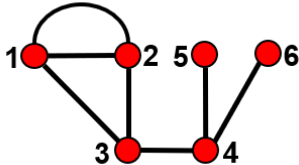
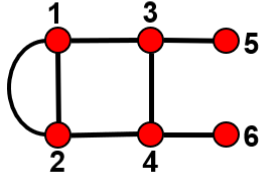
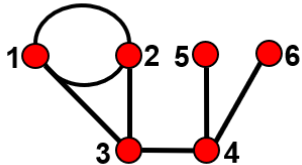
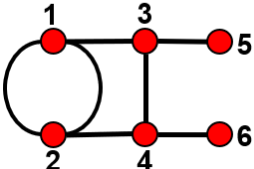
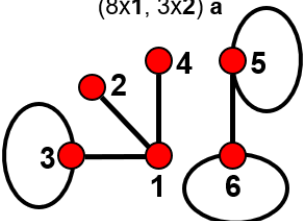
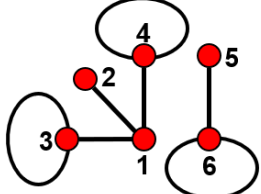
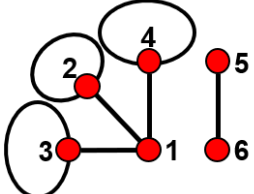
${}^1V_2{}^3V_2$	<p>(6x1, 1x2)</p> 	<p>(4x1, 2x2) a</p> 	<p>(4x1, 2x2) b</p> 	<p>(4x1, 2x2¹)</p> 
	<p>(4x1, 2x2²)</p> 			
${}^1V_2{}^3V_4$	<p>(14x1) a</p> 	<p>(14x1) b</p> 	<p>(12x1, 1x2)</p> 	<p>(10x1, 2x2) a</p> 
	<p>(10x1, 2x2) b</p> 	<p>(10x1, 2x2¹) a</p> 	<p>(10x1, 2x2¹) b</p> 	<p>(10x1, 2x2²) a</p> 
	<p>(10x1, 2x2²) b</p> 	<p>(8x1, 3x2) a</p> 	<p>(8x1, 3x2) b</p> 	<p>(8x1, 3x2) c</p> 

	<p>(8x1, 1x2, 2x2¹) a</p>	<p>(8x1, 1x2, 2x2¹) b</p>	<p>(8x1, 1x2, 2x2¹) c</p>	<p>(8x1, 1x2, 2x2¹) d</p>
	<p>(8x1, 1x2, 2x2²) a</p>	<p>(8x1, 1x2, 2x2²) b</p>	<p>(8x1, 1x2, 2x2²) c</p>	<p>(8x1, 1x2, 2x2²) d</p>
	<p>(6x1, 4x2) a</p>	<p>(6x1, 4x2) b</p>	<p>(6x1, 2x2, 2x2¹) a</p>	<p>(6x1, 2x2, 2x2¹) b</p>
	<p>(6x1, 2x2, 2x2¹) c</p>	<p>(6x1, 2x2, 2x2²) a</p>	<p>(6x1, 2x2, 2x2²) b</p>	<p>(6x1, 2x2, 2x2²) c</p>

	<p>(6x1, 4x2¹) a</p>	<p>(6x1, 4x2¹) b</p>	<p>(6x1, 2x2¹, 2x2²) a</p>	<p>(6x1, 2x2¹, 2x2²) b</p>
	<p>(6x1, 4x2²) a</p>	<p>(6x1, 4x2²) b</p>		
${}^1V_2{}^3V_6$	NG			
${}^1V_3{}^3V_1$	<p>(6x1)</p>	<p>(4x1, 1x2)</p>		
${}^1V_3{}^3V_3$	<p>(12x1)</p>	<p>(10x1, 1x2)</p>	<p>(8x1, 2x2) a</p>	<p>(8x1, 2x2) b</p>

	<p>(8x1, 2x2) c</p>	<p>(8x1, 2x2¹) a</p>	<p>(8x1, 2x2¹) b</p>	<p>(8x1, 2x2²) a</p>
	<p>(8x1, 2x2²) b</p>	<p>(6x1, 3x2) a</p>	<p>(6x1, 3x2) b</p>	<p>(6x1, 1x2, 2x2¹) a</p>
	<p>(6x1, 1x2, 2x2¹) b</p>	<p>(6x1, 1x2, 2x2²) a</p>	<p>(6x1, 1x2, 2x2²) b</p>	
${}^1V_3{}^3V_5$	NG			

${}^1V_4^3V_2$	(10x1) 	(8x1, 1x2) a 	(8x1, 1x2) b 	(6x1, 2x2) a
	(6x1, 2x2) b 	(6x1, 2x2^1) 	(6x1, 2x2^2) 	
${}^1V_4^3V_4$	NG			
${}^1V_5^3V_1$	(8x1) 	(6x1, 1x2) 		
${}^1V_5^3V_3$	NG			
${}^1V_6^3V_2$	NG			
${}^1V_7^3V_1$	NG			
${}^1V_r^4V_r$				
${}^1V_2^4V_1$	(4x1, 1x2) 			

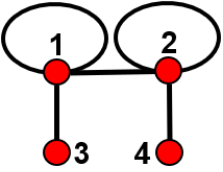
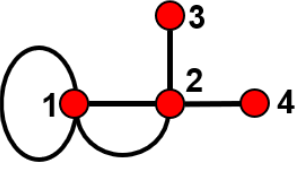
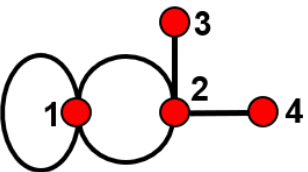
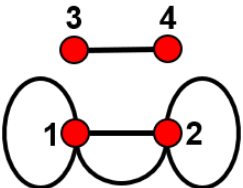
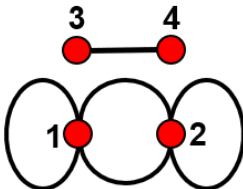
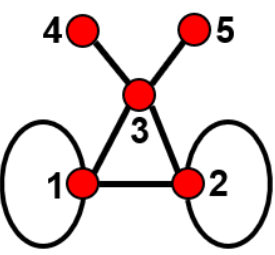
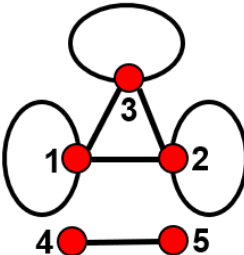
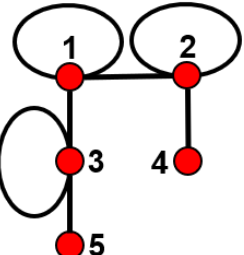
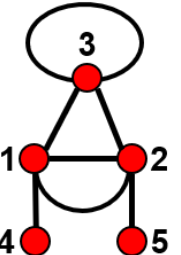
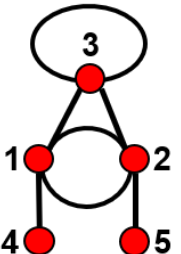
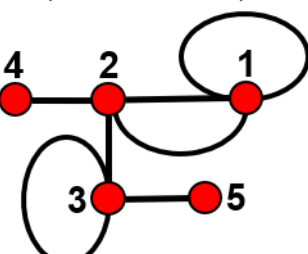
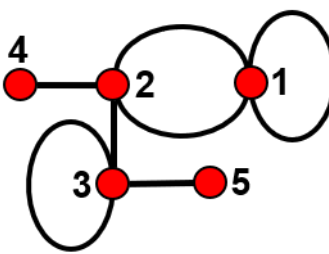
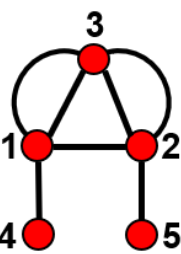
${}^1V_2^4V_2$	<p>(6x1, 2x2)</p> 	<p>(4x1, 1x2, 2x2¹)</p> 	<p>(4x1, 1x2, 2x2²)</p> 	<p>(2x1, 2x2, 2x2¹)</p> 
	<p>(2x1, 2x2, 2x2²)</p> 			
${}^1V_2^4V_3$	<p>(10x1, 2x2)</p> 	<p>(8x1, 3x2) a</p> 	<p>(8x1, 3x2) b</p> 	<p>(8x1, 1x2, 2x2¹)</p> 
	<p>(8x1, 1x2, 2x2²)</p> 	<p>(6x1, 2x2, 2x2¹)</p> 	<p>(6x1, 2x2, 2x2²)</p> 	<p>(6x1, 4x2¹)</p> 

	<p>(6x1, 2x2¹, 2x2²)</p>	<p>(6x1, 4x2²)</p>	<p>(4x1, 3x2, 2x2¹)</p>	<p>(4x1, 3x2, 2x2²)</p>
	<p>(4x1, 1x2, 4x2¹)</p>	<p>(4x1, 1x2, 2x2¹, 2x2²)</p>	<p>(4x1, 1x2, 4x2²)</p>	<p>(2x1, 2x2, 4x2¹)</p>
	<p>(2x1, 2x2, 2x2¹, 2x2²)</p>	<p>(2x1, 2x2, 4x2²)</p>	<p>(2x1, 6x2¹)</p>	<p>(2x1, 4x2¹, 2x2²)</p>

	<p>(2x1, 2x2¹, 4x2²)</p>	<p>(2x1, 6x2²)</p>		
${}^1V_2^4V_4$	<p>(14x1, 2x2)</p>	<p>(14x1, 2x2¹)</p>	<p>(14x1, 2x2²)</p>	<p>(12x1, 3x2) a</p>
	<p>(12x1, 3x2) b</p>	<p>(12x1, 1x2, 2x2¹) a</p>	<p>(12x1, 1x2, 2x2¹) b</p>	<p>(12x1, 1x2, 2x2²) a</p>
	<p>(12x1, 1x2, 2x2²) b</p>	<p>(10x1, 4x2) a</p>	<p>(10x1, 4x2) b</p>	<p>(10x1, 4x2) c</p>

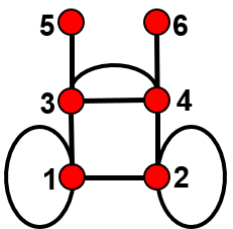
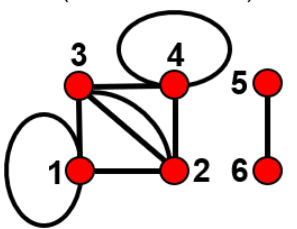
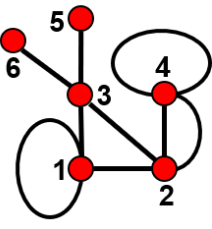
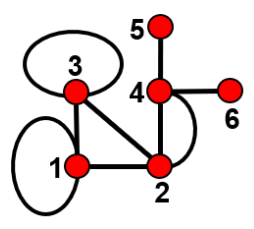
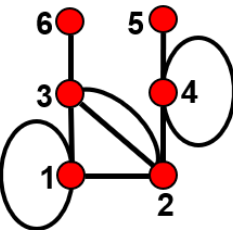
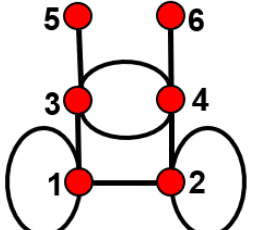
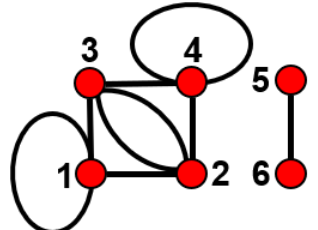
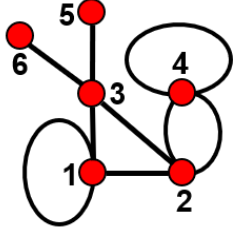
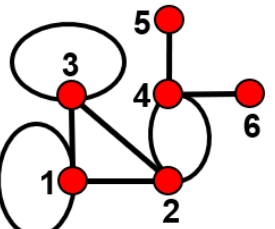
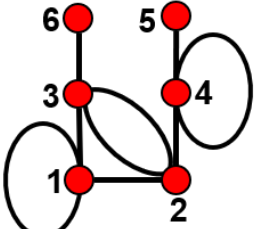
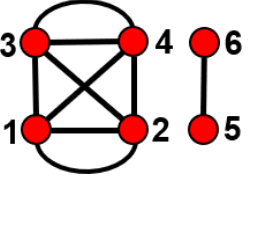
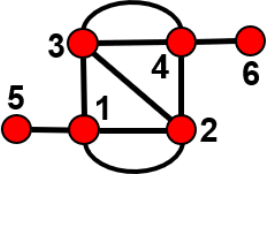
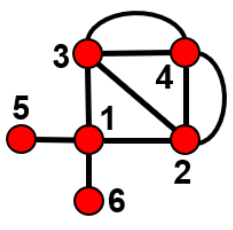
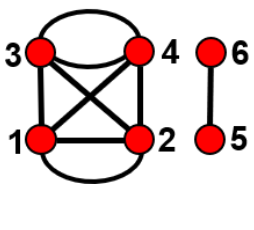
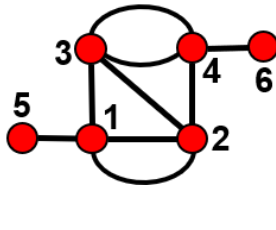
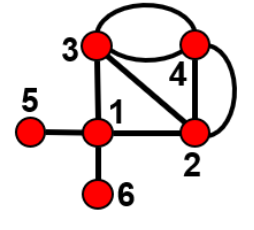
	(10x1, 2x2, 2x2 ¹) a 	(10x1, 2x2, 2x2 ¹) b 	(10x1, 2x2, 2x2 ¹) c 	(10x1, 2x2, 2x2 ¹) d 
	(10x1, 2x2, 2x2 ²) e 	(10x1, 2x2, 2x2 ²) a 	(10x1, 2x2, 2x2 ²) b 	(10x1, 2x2, 2x2 ²) c 
	(10x1, 2x2, 2x2 ²) d 	(10x1, 2x2, 2x2 ²) e 	(10x1, 4x2 ¹) a 	(10x1, 4x2 ¹) b 
	(10x1, 4x2 ¹) c 	(10x1, 2x2 ¹ , 2x2 ²) a 	(10x1, 2x2 ¹ , 2x2 ²) b 	(10x1, 2x2 ¹ , 2x2 ²) c 

	<p>(10x1, 4x2²) a</p>	<p>(10x1, 4x2²) b</p>	<p>(10x1, 4x2²) c</p>	<p>(8x1, 3x2, 2x2¹) a</p>
	<p>(8x1, 3x2, 2x2¹) b</p>	<p>(8x1, 3x2, 2x2¹) c</p>	<p>(8x1, 3x2, 2x2²) a</p>	<p>(8x1, 3x2, 2x2²) b</p>
	<p>(8x1, 3x2, 2x2²) c</p>	<p>(8x1, 1x2, 4x2¹) a</p>	<p>(8x1, 1x2, 4x2¹) b</p>	<p>(8x1, 1x2, 4x2¹) c</p>
	<p>(8x1, 1x2, 4x2¹) d</p>	<p>(8x1, 1x2, 2x2¹, 2x2²) a</p>	<p>(8x1, 1x2, 2x2¹, 2x2²) b</p>	<p>(8x1, 1x2, 2x2¹, 2x2²) c</p>

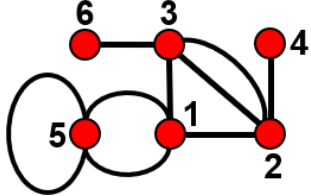
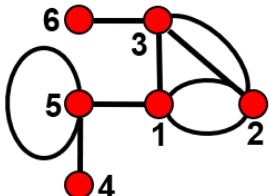
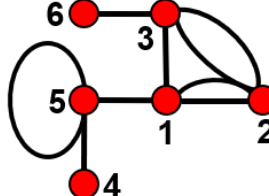
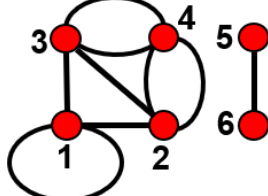
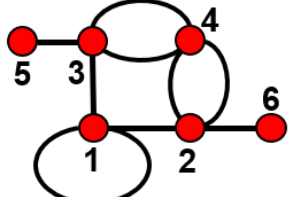
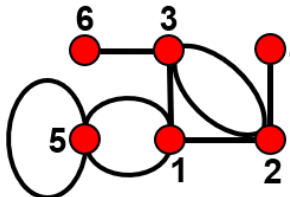
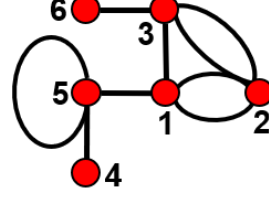
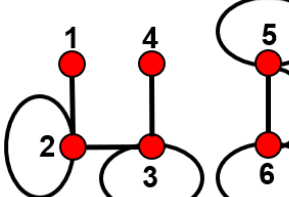
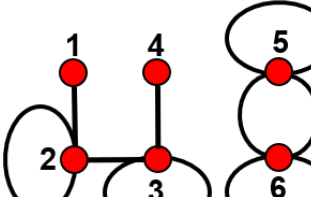
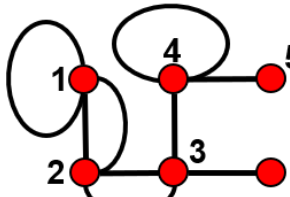
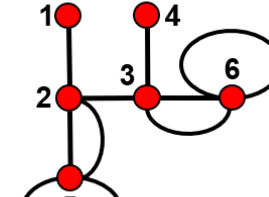
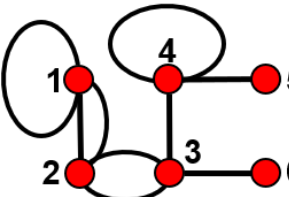
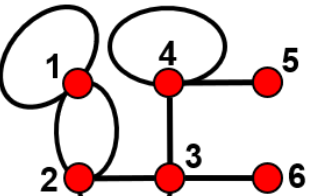
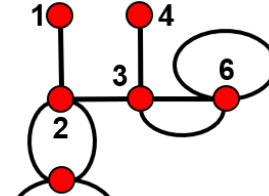
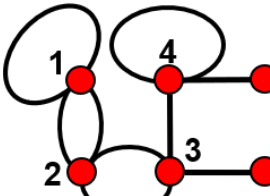
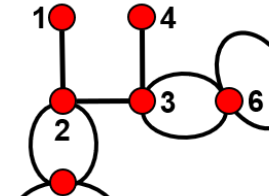
	<p>(8x1, 1x2, 2x2¹, 2x2²) d</p> 	<p>(8x1, 1x2, 2x2¹, 2x2²) e</p> 	<p>(8x1, 1x2, 2x2¹, 2x2²) f</p> 	<p>(8x1, 1x2, 4x2²) a</p> 
	<p>(8x1, 1x2, 4x2²) b</p> 	<p>(8x1, 1x2, 4x2²) c</p> 	<p>(8x1, 1x2, 4x2²) d</p> 	<p>(6x1, 4x2, 2x2¹)</p> 
	<p>(6x1, 4x2, 2x2²)</p> 	<p>(6x1, 2x2, 4x2¹) a</p> 	<p>(6x1, 2x2, 4x2¹) b</p> 	<p>(6x1, 2x2, 2x2¹, 2x2²) a</p> 
	<p>(6x1, 2x2, 2x2¹, 2x2²) b</p> 	<p>(6x1, 2x2, 2x2¹, 2x2²) c</p> 	<p>(6x1, 2x2, 4x2²) a</p> 	<p>(6x1, 2x2, 4x2²) b</p> 

	<p>(6x1, 6x2¹)</p>	<p>(6x1, 4x2¹, 2x2²) a</p>	<p>(6x1, 4x2¹, 2x2²) b</p>	<p>(6x1, 2x2¹, 4x2²) a</p>
	<p>(6x1, 2x2¹, 4x2²) b</p>	<p>(6x1, 6x2²)</p>	<p>(4x1, 3x2, 4x2¹) a</p>	<p>(4x1, 3x2, 4x2¹) b</p>
	<p>(4x1, 3x2, 2x2¹, 2x2²) a</p>	<p>(4x1, 3x2, 2x2¹, 2x2²) b</p>	<p>(4x1, 3x2, 2x2¹, 2x2²) c</p>	<p>(4x1, 3x2, 4x2²) a</p>
	<p>(4x1, 3x2, 4x2²) b</p>	<p>(4x1, 1x2, 6x2¹) a</p>	<p>(4x1, 1x2, 6x2¹) b</p>	<p>(4x1, 1x2, 4x2¹, 2x2²) a</p>

	<p>$(4x1, 1x2, 4x2^1, 2x2^2)$ b</p>	<p>$(4x1, 1x2, 4x2^1, 2x2^2)$ c</p>	<p>$(4x1, 1x2, 4x2^1, 2x2^2)$ d</p>	<p>$(4x1, 1x2, 2x2^1, 4x2^2)$ a</p>
	<p>$(4x1, 1x2, 2x2^1, 4x2^2)$ b</p>	<p>$(4x1, 1x2, 2x2^1, 4x2^2)$ c</p>	<p>$(4x1, 1x2, 2x2^1, 4x2^2)$ d</p>	<p>$(4x1, 1x2, 6x2^2)$ a</p>
	<p>$(4x1, 1x2, 6x2^2)$ b</p>	<p>$(2x1, 4x2, 4x2^1)$</p>	<p>$(2x1, 4x2, 2x2^1, 2x2^2)$</p>	<p>$(2x1, 4x2, 4x2^2)$</p>

	<p>(2x1, 2x2, 6x2¹)</p>	<p>(2x1, 2x2, 4x2¹, 2x2²) a</p>	<p>(2x1, 2x2, 4x2¹, 2x2²) b</p>	<p>(2x1, 2x2, 2x2¹, 4x2²) a</p>
	<p>(2x1, 2x2, 2x2¹, 4x2²) b</p>	<p>(2x1, 2x2, 6x2²)</p>	<p>(2x1, 8x2¹)</p>	<p>(2x1, 6x2¹, 2x2²)</p>
	<p>(2x1, 4x2¹, 4x2²) a</p>	<p>(2x1, 4x2¹, 4x2²) b</p>	<p>(2x1, 2x2¹, 6x2²)</p>	<p>(2x1, 8x2²)</p>
${}^1V_2^4V_5$	NG			
${}^1V_2^4V_6$	NG			

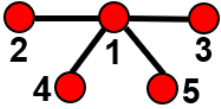
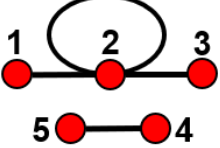
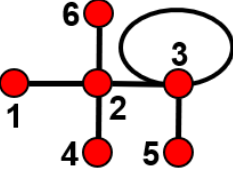
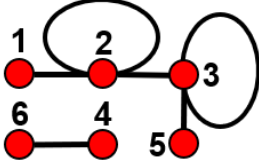
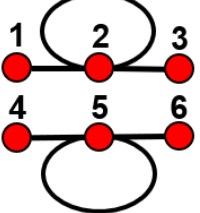
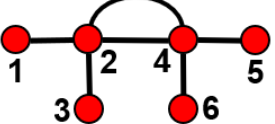
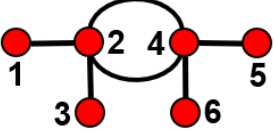
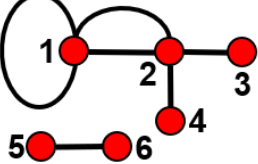
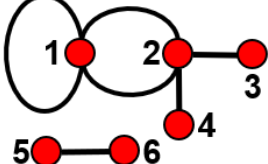
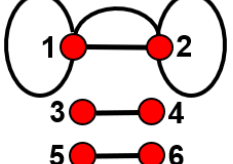
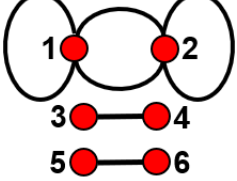
${}^1V_4^4V_1$	(8x1) 	(6x1, 1x2) 		
${}^1V_4^4V_2$	(10x1, 1x2) 	(8x1, 2x2) a 	(8x1, 2x2) b 	(8x1, 2x2 ¹) 
	(8x1, 2x2 ²) 	(6x1, 1x2, 2x2 ¹) 	(6x1, 1x2, 2x2 ²) 	(4x1, 2x2, 2x2 ¹) 
	(4x1, 2x2, 2x2 ²) 			
${}^1V_4^4V_3$	NG			
${}^1V_4^4V_4$	NG			

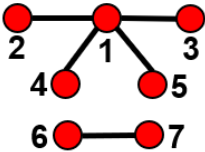
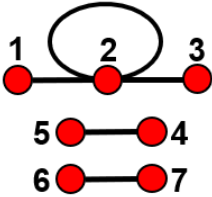
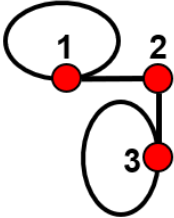
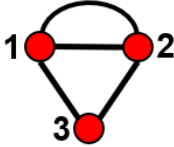
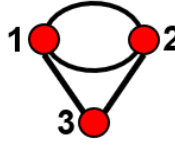
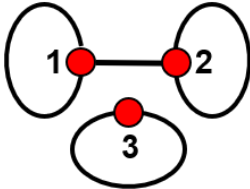
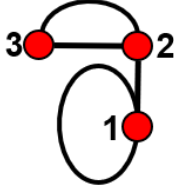
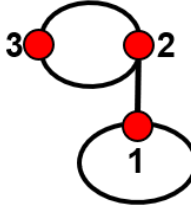
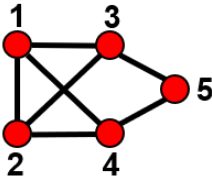
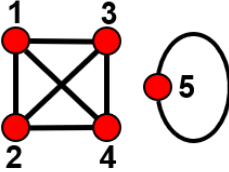
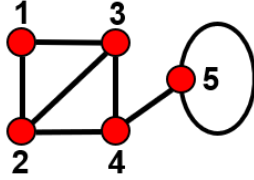
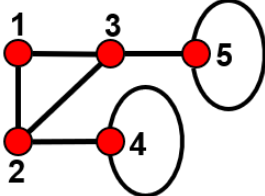
${}^1V_6^4V_1$	(10x1) 	(8x1, 1x2) 		
${}^1V_6^4V_2$	NG			
${}^2V_r^3V_r$				
${}^2V_i^3V_2$	(4x1, 2x2) 	(4x1, 2x2^1) 	(4x1, 2x2^2) 	(2x1, 3x2) 
	(2x1, 1x2, 2x2^1) 	(2x1, 1x2, 2x2^2) 		
${}^2V_i^3V_4$	(14x1) 	(12x1, 1x2) a 	(12x1, 1x2) b 	(10x1, 2x2) 

	<p>(10x1, 2x2¹)</p>	<p>(10x1, 2x2²)</p>	<p>(8x1, 3x2)</p>	<p>(8x1, 1x2, 2x2¹) a</p>
	<p>(8x1, 1x2, 2x2¹) b</p>	<p>(8x1, 1x2, 2x2²) a</p>	<p>(8x1, 1x2, 2x2²) b</p>	<p>(6x1, 4x2) a</p>
	<p>(6x1, 4x2) b</p>	<p>(6x1, 2x2, 2x2¹) a</p>	<p>(6x1, 2x2, 2x2¹) b</p>	<p>(6x1, 2x2, 2x2¹) c</p>
	<p>(6x1, 2x2, 2x2¹) d</p>	<p>(6x1, 2x2, 2x2²) a</p>	<p>(6x1, 2x2, 2x2²) b</p>	<p>(6x1, 2x2, 2x2²) c</p>

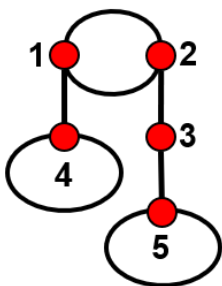
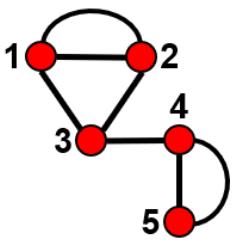
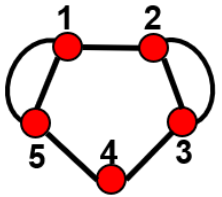
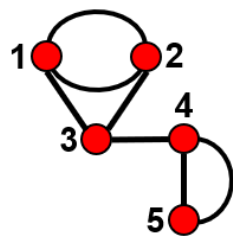
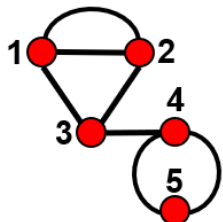
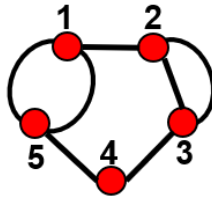
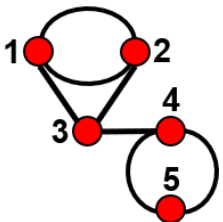
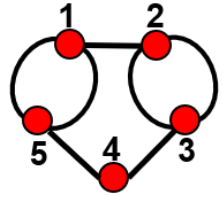
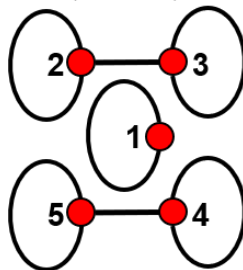
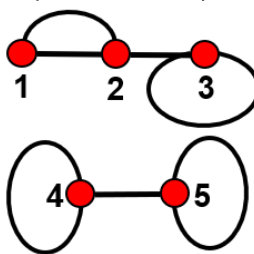
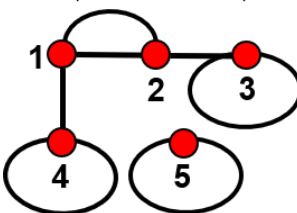
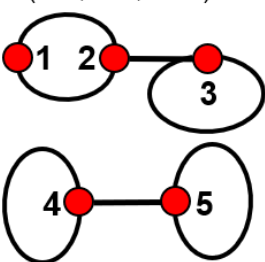
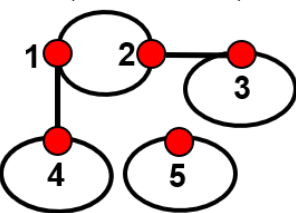
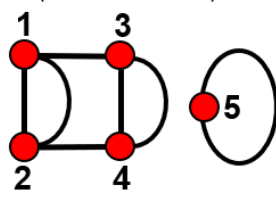
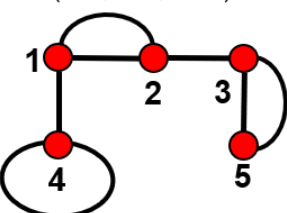
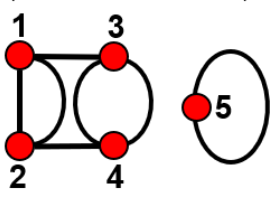
	<p>(6x1, 2x2, 2x2²) d</p> 	<p>(6x1, 4x2¹) a</p> 	<p>(6x1, 4x2¹) b</p> 	<p>(6x1, 2x2¹, 2x2²) a</p> 
	<p>(6x1, 2x2¹, 2x2²) b</p> 	<p>(6x1, 2x2¹, 2x2²) c</p> 	<p>(6x1, 4x2²) a</p> 	<p>(6x1, 4x2²) b</p> 
	<p>(4x1, 5x2)</p> 	<p>(4x1, 3x2, 2x2¹) a</p> 	<p>(4x1, 3x2, 2x2¹) b</p> 	<p>(4x1, 3x2, 2x2²) a</p> 
	<p>(4x1, 3x2, 2x2²) b</p> 	<p>(4x1, 1x2, 4x2¹) a</p> 	<p>(4x1, 1x2, 4x2¹) b</p> 	<p>(4x1, 1x2, 2x2¹, 2x2²) a</p> 

	(4x1, 1x2, 2x2 ¹ , 2x2 ²) b 	(4x1, 1x2, 2x2 ¹ , 2x2 ²) c 	(4x1, 1x2, 4x2 ²) a 	(4x1, 1x2, 4x2 ²) b
${}^2V_i{}^3V_6$	NG			
${}^2V_2{}^3V_2$	(10x1) 	(8x1, 1x2) 	(6x1, 2x2) 	(6x1, 2x2 ¹)
	(6x1, 2x2 ²) 	(4x1, 3x2) 	(4x1, 1x2, 2x2 ¹) a 	(4x1, 1x2, 2x2 ¹) b
	(4x1, 1x2, 2x2 ²) a 	(4x1, 1x2, 2x2 ²) b 	(2x1, 4x2) 	(2x1, 2x2, 2x2 ¹) a

	<p>(2x1, 2x2, 2x2¹) b</p>	<p>(2x1, 2x2, 2x2²) a</p>	<p>(2x1, 2x2, 2x2²) b</p>	<p>(2x1, 4x2¹)</p>
	<p>(2x1, 2x2¹, 2x2²)</p>	<p>(2x1, 4x2²)</p>		
${}^2V_2^3V_4$	<p>(16x1) a</p>	<p>(16x1) b</p>	<p>(16x1) c</p>	<p>(16x1) d</p>
	<p>(14x1, 1x2) a</p>	<p>(14x1, 1x2) b</p>	<p>(14x1, 1x2) c</p>	<p>(14x1, 1x2) d</p>

	<p>(14x1, 1x2) e</p>	<p>(12x1, 2x2) a</p>	<p>(12x1, 2x2) b</p>	<p>(12x1, 2x2) c</p>
	<p>(12x1, 2x2) d</p>	<p>(12x1, 2x2) e</p>	<p>(12x1, 2x2) f</p>	<p>(12x1, 2x2) g</p>
	<p>(12x1, 2x2^1) a</p>	<p>(12x1, 2x2^1) b</p>	<p>(12x1, 2x2^1) c</p>	<p>(12x1, 2x2^1) d</p>
	<p>(12x1, 2x2^1) e</p>	<p>(12x1, 2x2^1) f</p>	<p>(12x1, 2x2^2) a</p>	<p>(12x1, 2x2^2) b</p>

	<p>(12x1, 2x2²) c</p>	<p>(12x1, 2x2²) d</p>	<p>(12x1, 2x2²) e</p>	<p>(12x1, 2x2²) f</p>
	<p>(10x1, 3x2) a</p>	<p>(10x1, 3x2) b</p>	<p>(10x1, 3x2) c</p>	<p>(10x1, 3x2) d</p>
	<p>(10x1, 1x2, 2x2¹) a</p>	<p>(10x1, 1x2, 2x2¹) b</p>	<p>(10x1, 1x2, 2x2¹) c</p>	<p>(10x1, 1x2, 2x2¹) d</p>

	<p>(10x1, 1x2, 2x2¹) e</p>	<p>(10x1, 1x2, 2x2¹) f</p>	<p>(10x1, 1x2, 2x2¹) g</p>	<p>(10x1, 1x2, 2x2²) a</p>
	<p>(10x1, 1x2, 2x2²) b</p>	<p>(10x1, 1x2, 2x2²) c</p>	<p>(10x1, 1x2, 2x2²) d</p>	<p>(10x1, 1x2, 2x2²) e</p>
	<p>(10x1, 1x2, 2x2²) f</p>	<p>(10x1, 1x2, 2x2²) g</p>	<p>(8x1, 4x2) a</p>	<p>(8x1, 4x2) b</p>

	<p>(8x1, 4x2) c</p>	<p>(8x1, 2x2, 2x2¹) a</p>	<p>(8x1, 2x2, 2x2¹) b</p>	<p>(8x1, 2x2, 2x2¹) c</p>
	<p>(8x1, 2x2, 2x2¹) d</p>	<p>(8x1, 2x2, 2x2¹) e</p>	<p>(8x1, 2x2, 2x2¹) f</p>	<p>(8x1, 2x2, 2x2¹) g</p>
	<p>(8x1, 2x2, 2x2²) h</p>	<p>(8x1, 2x2, 2x2²) a</p>	<p>(8x1, 2x2, 2x2²) b</p>	<p>(8x1, 2x2, 2x2²) c</p>
	<p>(8x1, 2x2, 2x2²) d</p>	<p>(8x1, 2x2, 2x2²) e</p>	<p>(8x1, 2x2, 2x2²) f</p>	<p>(8x1, 2x2, 2x2²) g</p>

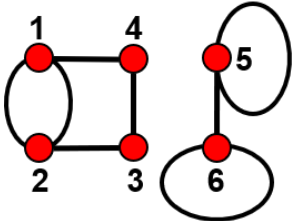
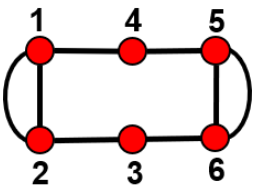
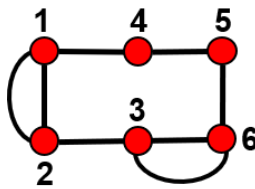
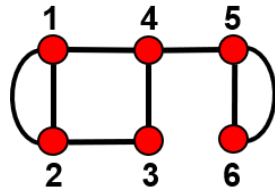
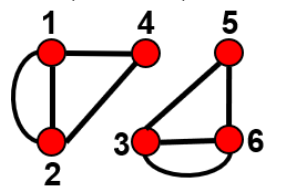
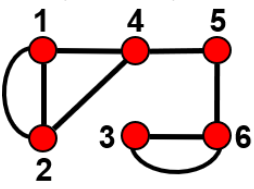
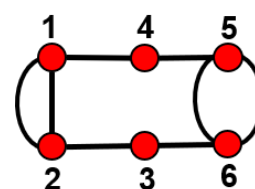
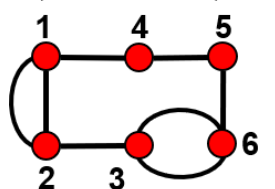
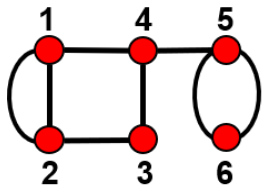
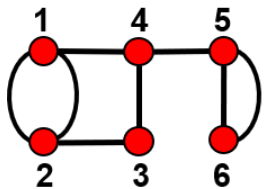
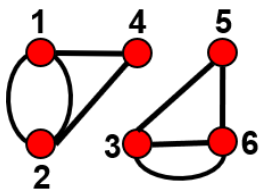
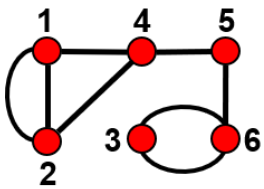
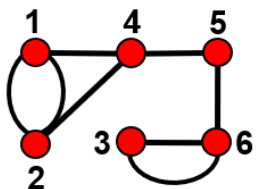
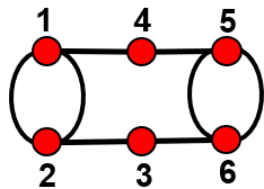
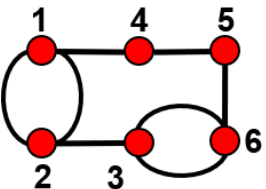
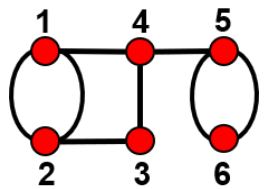
	<p>(8x1, 2x2, 2x2²) h</p> 	<p>(8x1, 4x2¹) a</p> 	<p>(8x1, 4x2¹) b</p> 	<p>(8x1, 4x2¹) c</p> 
	<p>(8x1, 4x2¹) d</p> 	<p>(8x1, 4x2¹) e</p> 	<p>(8x1, 2x2¹, 2x2²) a</p> 	<p>(8x1, 2x2¹, 2x2²) b</p> 
	<p>(8x1, 2x2¹, 2x2²) c</p> 	<p>(8x1, 2x2¹, 2x2²) d</p> 	<p>(8x1, 2x2¹, 2x2²) e</p> 	<p>(8x1, 2x2¹, 2x2²) f</p> 
	<p>(8x1, 2x2¹, 2x2²) g</p> 	<p>(8x1, 4x2²) a</p> 	<p>(8x1, 4x2²) b</p> 	<p>(8x1, 4x2²) c</p> 

	<p>(8x1, 4x2¹) d</p>	<p>(8x1, 4x2²) e</p>	<p>(6x1, 5x2) a</p>	<p>(6x1, 5x2) b</p>
	<p>(6x1, 3x2, 2x2¹) a</p>	<p>(6x1, 3x2, 2x2¹) b</p>	<p>(6x1, 3x2, 2x2¹) c</p>	<p>(6x1, 3x2, 2x2¹) d</p>
	<p>(6x1, 3x2, 2x2¹) e</p>	<p>(6x1, 3x2, 2x2¹) f</p>	<p>(6x1, 3x2, 2x2¹) g</p>	<p>(6x1, 3x2, 2x2²) a</p>
	<p>(6x1, 3x2, 2x2²) b</p>	<p>(6x1, 3x2, 2x2²) c</p>	<p>(6x1, 3x2, 2x2²) d</p>	<p>(6x1, 3x2, 2x2²) e</p>

	<p>(6x1, 3x2, 2x2²) f</p>	<p>(6x1, 3x2, 2x2²) g</p>	<p>(6x1, 1x2, 4x2¹) a</p>	<p>(6x1, 1x2, 4x2¹) b</p>
	<p>(6x1, 1x2, 4x2¹) c</p>	<p>(6x1, 1x2, 4x2¹) d</p>	<p>(6x1, 1x2, 4x2¹) e</p>	<p>(6x1, 1x2, 4x2¹) f</p>
	<p>(6x1, 1x2, 4x2¹) g</p>	<p>(6x1, 1x2, 2x2¹, 2x2²) a</p>	<p>(6x1, 1x2, 2x2¹, 2x2²) b</p>	<p>(6x1, 1x2, 2x2¹, 2x2²) c</p>
	<p>(6x1, 1x2, 2x2¹, 2x2²) d</p>	<p>(6x1, 1x2, 2x2¹, 2x2²) e</p>	<p>(6x1, 1x2, 2x2¹, 2x2²) f</p>	<p>(6x1, 1x2, 2x2¹, 2x2²) g</p>

	<p>(6x1, 1x2, 2x2¹, 2x2²) h</p>	<p>(6x1, 1x2, 2x2¹, 2x2²) i</p>	<p>(6x1, 1x2, 2x2¹, 2x2²) j</p>	<p>(6x1, 1x2, 2x2¹, 2x2²) k</p>
	<p>(6x1, 1x2, 2x2¹, 2x2²) l</p>	<p>(6x1, 1x2, 4x2²) a</p>	<p>(6x1, 1x2, 4x2²) b</p>	<p>(6x1, 1x2, 4x2²) c</p>
	<p>(6x1, 1x2, 4x2²) d</p>	<p>(6x1, 1x2, 4x2²) e</p>	<p>(6x1, 1x2, 4x2²) f</p>	<p>(6x1, 1x2, 4x2²) g</p>
	<p>(4x1, 4x2, 2x2¹) a</p>	<p>(4x1, 4x2, 2x2¹) b</p>	<p>(4x1, 4x2, 2x2¹) c</p>	<p>(4x1, 4x2, 2x2²) a</p>

	<p>(4x1, 4x2, 2x2²) b</p>	<p>(4x1, 4x2, 2x2²) c</p>	<p>(4x1, 2x2, 4x2¹) a</p>	<p>(4x1, 2x2, 4x2¹) b</p>
	<p>(4x1, 2x2, 4x2¹) c</p>	<p>(4x1, 2x2, 4x2¹) d</p>	<p>(4x1, 2x2, 4x2¹) e</p>	<p>(4x1, 2x2, 2x2¹, 2x2²) a</p>
	<p>(4x1, 2x2, 2x2¹, 2x2²) b</p>	<p>(4x1, 2x2, 2x2¹, 2x2²) c</p>	<p>(4x1, 2x2, 2x2¹, 2x2²) d</p>	<p>(4x1, 2x2, 2x2¹, 2x2²) e</p>

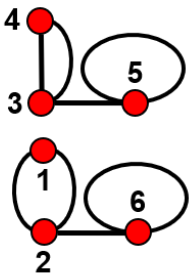
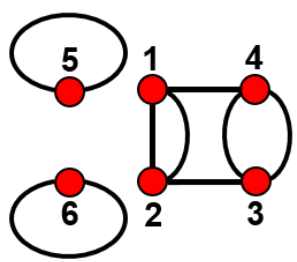
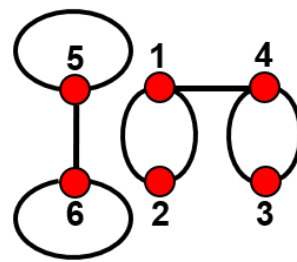
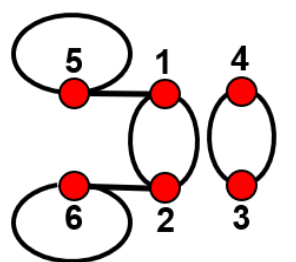
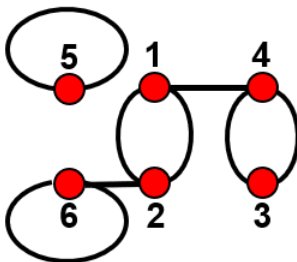
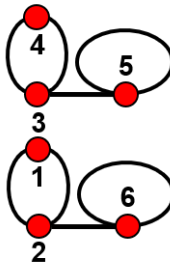
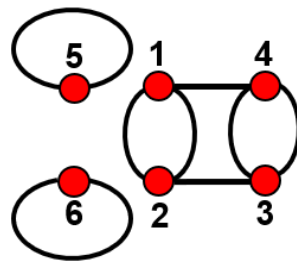
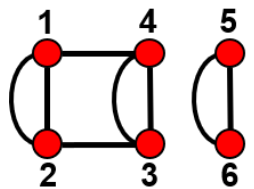
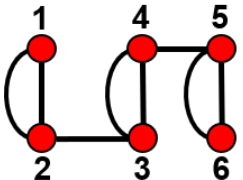
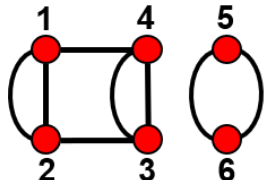
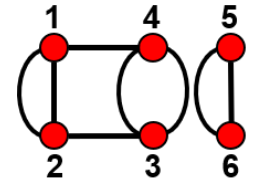
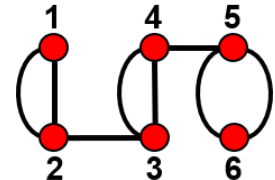
	<p>$(4x1, 2x2, 2x2^1, 2x2^2)$ f</p> 	<p>$(4x1, 2x2, 2x2^1, 2x2^2)$ g</p> 	<p>$(4x1, 2x2, 4x2^2)$ a</p> 	<p>$(4x1, 2x2, 4x2^2)$ b</p> 
	<p>$(4x1, 2x2, 4x2^2)$ c</p> 	<p>$(4x1, 2x2, 4x2^2)$ d</p> 	<p>$(4x1, 2x2, 4x2^2)$ e</p> 	<p>$(4x1, 6x2^1)$ a</p> 
	<p>$(4x1, 6x2^1)$ b</p> 	<p>$(4x1, 4x2^1, 2x2^2)$ a</p> 	<p>$(4x1, 4x2^1, 2x2^2)$ b</p> 	<p>$(4x1, 4x2^1, 2x2^2)$ c</p> 

	(4x1, 4x2 ¹ , 2x2 ²) d 	(4x1, 2x2 ¹ , 4x2 ²) a 	(4x1, 2x2 ¹ , 4x2 ²) b 	(4x1, 2x2 ¹ , 4x2 ²) c
	(4x1, 2x2 ¹ , 4x2 ²) d 	(4x1, 6x2 ²) a 	(4x1, 6x2 ²) b 	
${}^2V_2{}^3V_6$	NG			
${}^2V_2{}^3V_8$	NG			
${}^2V_3{}^3V_2$	(12x1) a 	(12x1) b 	(10x1, 1x2) a 	(10x1, 1x2) b
	(10x1, 1x2) c 	(8x1, 2x2) a 	(8x1, 2x2) b 	(8x1, 2x2) c

	<p>(8x1, 2x2¹) a</p>	<p>(8x1, 2x2¹) b</p>	<p>(8x1, 2x2²) a</p>	<p>(8x1, 2x2²) b</p>
	<p>(6x1, 3x2)</p>	<p>(6x1, 1x2, 2x2¹) a</p>	<p>(6x1, 1x2, 2x2¹) b</p>	<p>(6x1, 1x2, 2x2²) a</p>
	<p>(6x1, 1x2, 2x2²) b</p>	<p>(4x1, 4x2)</p>	<p>(4x1, 2x2, 2x2¹) a</p>	<p>(4x1, 2x2, 2x2¹) b</p>
	<p>(4x1, 2x2, 2x2¹) c</p>	<p>(4x1, 2x2, 2x2²) a</p>	<p>(4x1, 2x2, 2x2²) b</p>	<p>(4x1, 2x2, 2x2²) c</p>

	<p>(4x1, 4x2¹) a</p>	<p>(4x1, 4x2¹) b</p>	<p>(4x1, 2x2¹, 2x2²) a</p>	<p>(4x1, 2x2¹, 2x2²) b</p>
	<p>(4x1, 2x2¹, 2x2²) c</p>	<p>(4x1, 4x2²) a</p>	<p>(4x1, 4x2²) b</p>	<p>(2x1, 5x2)</p>
	<p>(2x1, 3x2, 2x2¹) a</p>	<p>(2x1, 3x2, 2x2¹) b</p>	<p>(2x1, 3x2, 2x2²) a</p>	<p>(2x1, 3x2, 2x2²) b</p>
	<p>(2x1, 1x2, 4x2¹) a</p>	<p>(2x1, 1x2, 4x2¹) b</p>	<p>(2x1, 1x2, 2x2¹, 2x2²) a</p>	<p>(2x1, 1x2, 2x2¹, 2x2²) b</p>

	<p>(2x1, 1x2, 2x2¹, 2x2²) c</p>	<p>(2x1, 1x2, 4x2²) a</p>	<p>(2x1, 1x2, 4x2²) b</p>	
${}^2V_3{}^3V_4$	NG			
${}^2V_4{}^3V_2$	<p>(14x1) a</p>	<p>(14x1) b</p>	<p>(14x1) c</p>	<p>(14x1) d</p>
	<p>(12x1, 1x2) a</p>	<p>(12x1, 1x2) b</p>	<p>(12x1, 1x2) c</p>	<p>(12x1, 1x2) d</p>
	<p>(12x1, 1x2) e</p>	<p>(10x1, 2x2) a</p>	<p>(10x1, 2x2) b</p>	<p>(10x1, 2x2) c</p>

	<p>(10x1, 2x2) d</p>	<p>(10x1, 2x2) e</p>	<p>(10x1, 2x2) f</p>	<p>(10x1, 2x2¹) a</p>
	<p>(10x1, 2x2¹) b</p>	<p>(10x1, 2x2¹) c</p>	<p>(10x1, 2x2¹) d</p>	<p>(10x1, 2x2¹) e</p>
	<p>(10x1, 2x2²) a</p>	<p>(10x1, 2x2²) b</p>	<p>(10x1, 2x2²) c</p>	<p>(10x1, 2x2²) d</p>
	<p>(10x1, 2x2²) e</p>	<p>(8x1, 3x2) a</p>	<p>(8x1, 3x2) b</p>	<p>(8x1, 3x2) c</p>

	<p>(8x1, 1x2, 2x2¹) a</p>	<p>(8x1, 1x2, 2x2¹) b</p>	<p>(8x1, 1x2, 2x2¹) c</p>	<p>(8x1, 1x2, 2x2¹) d</p>
	<p>(8x1, 1x2, 2x2²) e</p>	<p>(8x1, 1x2, 2x2²) a</p>	<p>(8x1, 1x2, 2x2²) b</p>	<p>(8x1, 1x2, 2x2²) c</p>
	<p>(8x1, 1x2, 2x2²) d</p>	<p>(8x1, 1x2, 2x2²) e</p>	<p>(6x1, 4x2)</p>	<p>(6x1, 2x2, 2x2¹) a</p>
	<p>(6x1, 2x2, 2x2¹) b</p>	<p>(6x1, 2x2, 2x2¹) c</p>	<p>(6x1, 2x2, 2x2²) a</p>	<p>(6x1, 2x2, 2x2²) b</p>

	<p>(6x1, 2x2, 2x2²) c</p>	<p>(6x1, 4x2¹) a</p>	<p>(6x1, 4x2¹) b</p>	<p>(6x1, 2x2¹, 2x2²) a</p>
	<p>(6x1, 2x2¹, 2x2²) b</p>	<p>(6x1, 2x2¹, 2x2²) c</p>	<p>(6x1, 4x2²) a</p>	<p>(6x1, 4x2²) b</p>
	<p>(4x1, 5x2)</p>	<p>(4x1, 3x2, 2x2¹) a</p>	<p>(4x1, 3x2, 2x2¹) b</p>	<p>(4x1, 3x2, 2x2¹) c</p>

	<p>(4x1, 3x2, 2x2²) a</p>	<p>(4x1, 3x2, 2x2²) b</p>	<p>(4x1, 3x2, 2x2²) c</p>	<p>(4x1, 1x2, 4x2¹) a</p>
	<p>(4x1, 1x2, 4x2¹) b</p>	<p>(4x1, 1x2, 4x2¹) c</p>	<p>(4x1, 1x2, 2x2¹, 2x2²) a</p>	<p>(4x1, 1x2, 2x2¹, 2x2²) b</p>
	<p>(4x1, 1x2, 2x2¹, 2x2²) c</p>	<p>(4x1, 1x2, 2x2¹, 2x2²) d</p>	<p>(4x1, 1x2, 2x2¹, 2x2²) e</p>	<p>(4x1, 1x2, 4x2²) a</p>
	<p>(4x1, 1x2, 4x2²) b</p>	<p>(4x1, 1x2, 4x2²) c</p>	<p>(2x1, 6x2)</p>	<p>(2x1, 4x2, 2x2¹) a</p>

	<p>(2x1, 4x2, 2x2¹) b</p>	<p>(2x1, 4x2, 2x2²) a</p>	<p>(2x1, 4x2, 2x2²) b</p>	<p>(2x1, 2x2, 4x2¹) a</p>
	<p>(2x1, 2x2, 4x2¹) b</p>	<p>(2x1, 2x2, 4x2¹) c</p>	<p>(2x1, 2x2, 2x2¹, 2x2²) a</p>	<p>(2x1, 2x2, 2x2¹, 2x2²) b</p>
	<p>(2x1, 2x2, 2x2¹, 2x2²) c</p>	<p>(2x1, 2x2, 2x2¹, 2x2²) d</p>	<p>(2x1, 2x2, 4x2²) a</p>	<p>(2x1, 2x2, 4x2²) b</p>

	<p>(2x1, 2x2, 4x2²) c</p>	<p>(2x1, 6x2¹)</p>	<p>(2x1, 4x2¹, 2x2²) a</p>	<p>(2x1, 4x2¹, 2x2²) b</p>
	<p>(2x1, 2x2¹, 4x2²) a</p>	<p>(2x1, 2x2¹, 4x2²) b</p>	<p>(2x1, 6x2²)</p>	
${}^2V_4^3V_4$	NG			
${}^2V_5^3V_2$	NG			
${}^2V_6^3V_2$	NG			
${}^2V_r^4V_r$				
${}^2V_1^4V_1$	<p>(1x2, 2x2¹)</p>	<p>(1x2, 2x2²)</p>		

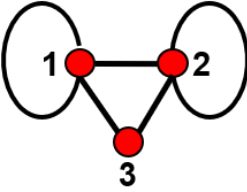
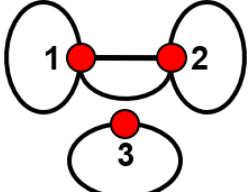
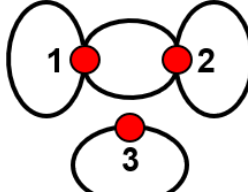
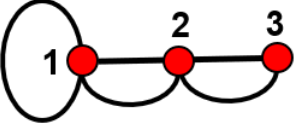
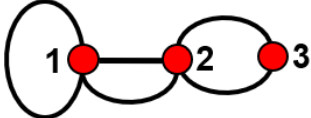
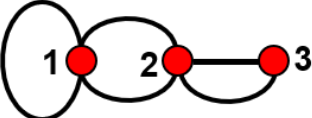
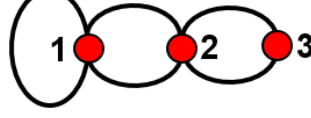
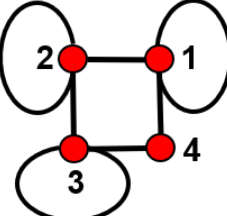
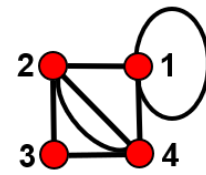
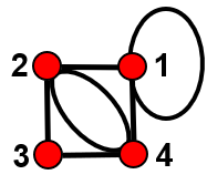
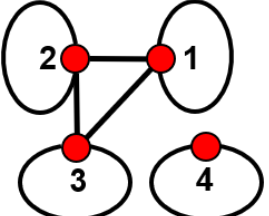
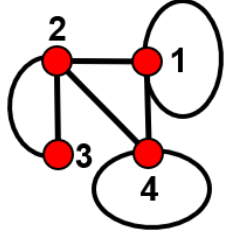
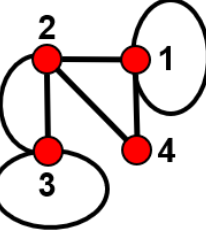
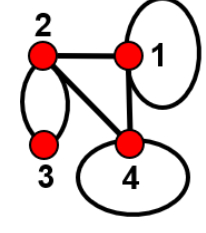
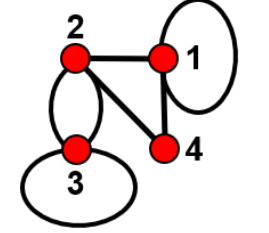
${}^2V_1^4V_2$	<p>(6x1, 2x2)</p> 	<p>(3x2, 2x2¹)</p> 	<p>(3x2, 2x2²)</p> 	<p>(1x2, 4x2¹)</p> 
	<p>(1x2, 2x2¹, 2x2²) a</p> 	<p>(1x2, 2x2¹, 2x2²) b</p> 	<p>(1x2, 4x2²)</p> 	
${}^2V_1^4V_3$	<p>(8x1, 3x2)</p> 	<p>(8x1, 1x2, 2x2¹)</p> 	<p>(8x1, 1x2, 2x2²)</p> 	<p>(6x1, 4x2)</p> 
	<p>(6x1, 2x2, 2x2¹) a</p> 	<p>(6x1, 2x2, 2x2¹) b</p> 	<p>(6x1, 2x2, 2x2²) a</p> 	<p>(6x1, 2x2, 2x2²) b</p> 

	<p>(6x1, 4x2¹)</p>	<p>(6x1, 2x2¹, 2x2²)</p>	<p>(6x1, 4x2²)</p>	<p>(3x2, 4x2¹) a</p>
	<p>(3x2, 4x2¹) b</p>	<p>(3x2, 2x2¹, 2x2²) a</p>	<p>(3x2, 2x2¹, 2x2²) b</p>	<p>(3x2, 2x2¹, 2x2²) c</p>
	<p>(3x2, 4x2²) a</p>	<p>(3x2, 4x2²) b</p>	<p>(1x2, 6x2¹) a</p>	<p>(1x2, 6x2¹) b</p>
	<p>(1x2, 4x2¹, 2x2²) a</p>	<p>(1x2, 4x2¹, 2x2²) b</p>	<p>(1x2, 4x2¹, 2x2²) c</p>	<p>(1x2, 4x2¹, 2x2²) d</p>

	<p>(1x2, 2x2¹, 4x2²) a</p>	<p>(1x2, 2x2¹, 4x2²) b</p>	<p>(1x2, 2x2¹, 4x2²) c</p>	<p>(1x2, 2x2¹, 4x2²) d</p>
	<p>(1x2, 6x2²) a</p>	<p>(1x2, 6x2²) b</p>		
${}^2V_1^4V_4$	<p>(14x1, 2x2)</p>	<p>(14x1, 2x2¹)</p>	<p>(14x1, 2x2²)</p>	<p>(12x1, 3x2)</p>
	<p>(12x1, 1x2, 2x2¹)</p>	<p>(12x1, 1x2, 2x2²)</p>	<p>(10x1, 4x2)</p>	<p>(10x1, 2x2, 2x2¹) a</p>

	<p>(10x1, 2x2, 2x2¹) b</p>	<p>(10x1, 2x2, 2x2²) a</p>	<p>(10x1, 2x2, 2x2²) b</p>	<p>(10x1, 4x2¹)</p>
	<p>(10x1, 2x2¹, 2x2²)</p>	<p>(10x1, 4x2²)</p>	<p>(8x1, 5x2)</p>	<p>(8x1, 3x2, 2x2¹) a</p>
	<p>(8x1, 3x2, 2x2¹) b</p>	<p>(8x1, 3x2, 2x2¹) c</p>	<p>(8x1, 3x2, 2x2¹) d</p>	<p>(8x1, 3x2, 2x2²) a</p>
	<p>(8x1, 3x2, 2x2²) b</p>	<p>(8x1, 3x2, 2x2²) c</p>	<p>(8x1, 3x2, 2x2²) d</p>	<p>(8x1, 1x2, 4x2¹) a</p>

	<p>($8x1, 1x2, 4x2^1$) b</p>	<p>($8x1, 1x2, 4x2^1$) c</p>	<p>($8x1, 1x2, 4x2^1$) d</p>	<p>($8x1, 1x2, 4x2^1$) e</p>
	<p>($8x1, 1x2, 2x2^1, 2x2^2$) a</p>	<p>($8x1, 1x2, 2x2^1, 2x2^2$) b</p>	<p>($8x1, 1x2, 2x2^1, 2x2^2$) c</p>	<p>($8x1, 1x2, 2x2^1, 2x2^2$) d</p>
	<p>($8x1, 1x2, 2x2^1, 2x2^2$) e</p>	<p>($8x1, 1x2, 2x2^1, 2x2^2$) f</p>	<p>($8x1, 1x2, 2x2^1, 2x2^2$) g</p>	<p>($8x1, 1x2, 2x2^1, 2x2^2$) h</p>
	<p>($8x1, 1x2, 4x2^2$) a</p>	<p>($8x1, 1x2, 4x2^2$) b</p>	<p>($8x1, 1x2, 4x2^2$) c</p>	<p>($8x1, 1x2, 4x2^2$) d</p>

	<p>(8x1, 1x2, 4x2²) e</p>	<p>(6x1, 4x2, 2x2¹) a</p>	<p>(6x1, 4x2, 2x2¹) b</p>	<p>(6x1, 4x2, 2x2¹) c</p>
	<p>(6x1, 4x2, 2x2²) a</p>	<p>(6x1, 4x2, 2x2²) b</p>	<p>(6x1, 4x2, 2x2²) c</p>	<p>(6x1, 2x2, 4x2¹) a</p>
	<p>(6x1, 2x2, 4x2¹) b</p>	<p>(6x1, 2x2, 4x2¹) c</p>	<p>(6x1, 2x2, 4x2¹) d</p>	<p>(6x1, 2x2, 4x2¹) e</p>

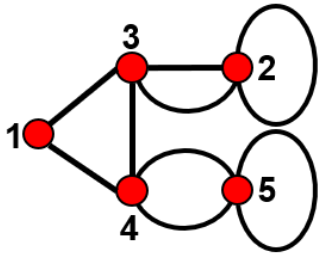
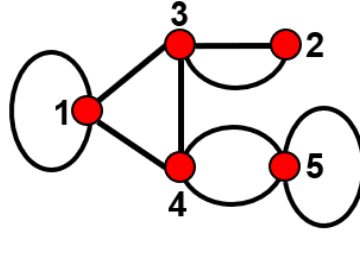
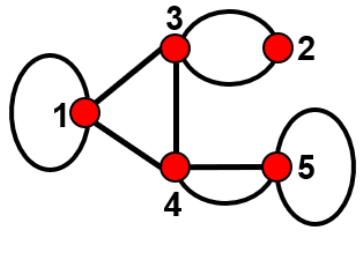
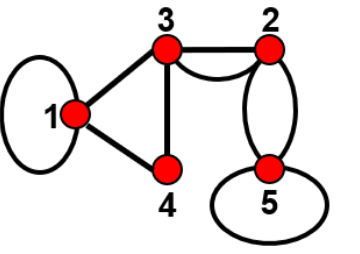
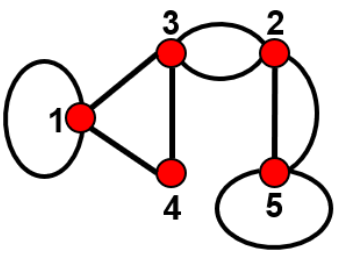
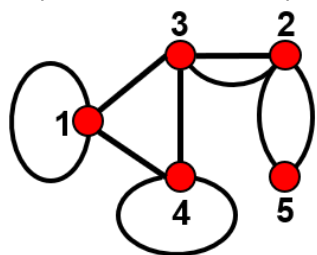
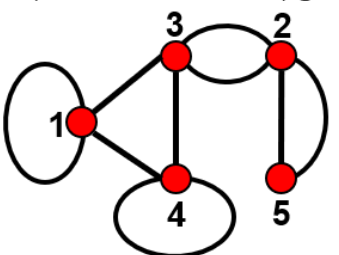
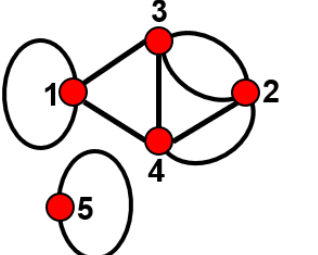
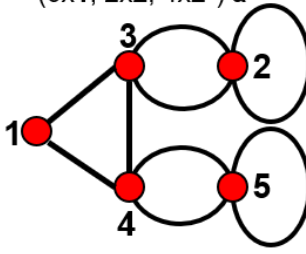
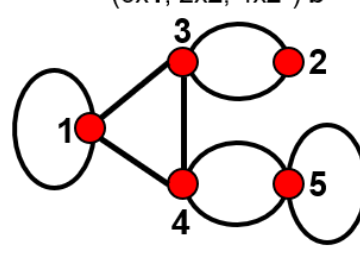
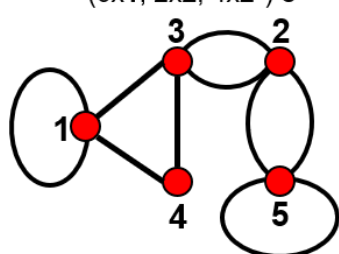
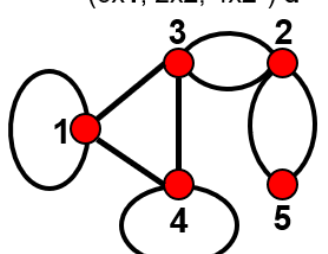
	<p>($6x1, 2x2, 2x2^1, 2x2^2$) a</p> 	<p>($6x1, 2x2, 2x2^1, 2x2^2$) b</p> 	<p>($6x1, 2x2, 2x2^1, 2x2^2$) c</p> 	<p>($6x1, 2x2, 2x2^1, 2x2^2$) d</p> 
	<p>($6x1, 2x2, 2x2^1, 2x2^2$) e</p> 	<p>($6x1, 2x2, 2x2^1, 2x2^2$) f</p> 	<p>($6x1, 2x2, 2x2^1, 2x2^2$) g</p> 	<p>($6x1, 2x2, 2x2^1, 2x2^2$) h</p> 
	<p>($6x1, 2x2, 4x2^2$) a</p> 	<p>($6x1, 2x2, 4x2^2$) b</p> 	<p>($6x1, 2x2, 4x2^2$) c</p> 	<p>($6x1, 2x2, 4x2^2$) d</p> 

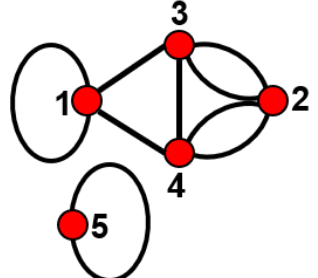
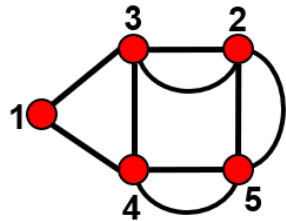
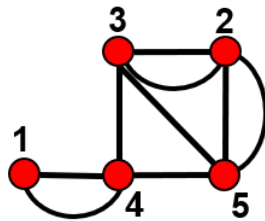
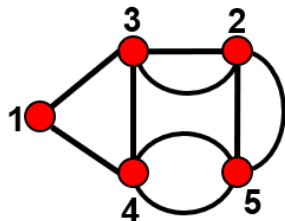
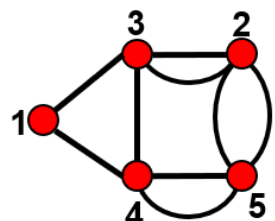
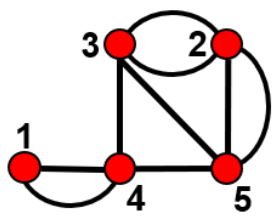
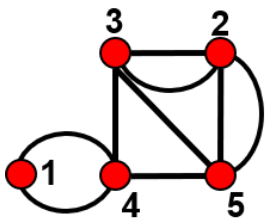
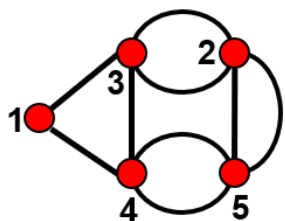
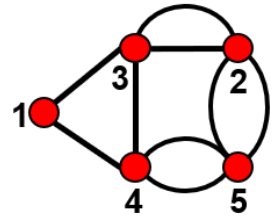
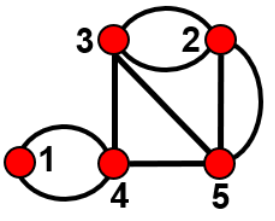
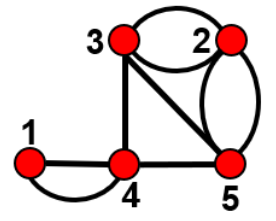
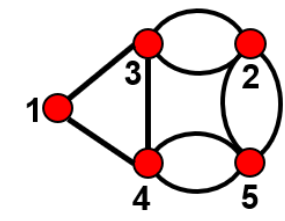
	<p>(6x1, 2x2, 4x2²) e</p> 	<p>(6x1, 6x2¹) a</p> 	<p>(6x1, 6x2¹) b</p> 	<p>(6x1, 4x2¹, 2x2²) a</p> 
	<p>(6x1, 4x2¹, 2x2²) b</p> 	<p>(6x1, 4x2¹, 2x2²) c</p> 	<p>(6x1, 4x2¹, 2x2²) d</p> 	<p>(6x1, 2x2¹, 4x2²) a</p> 
	<p>(6x1, 2x2¹, 4x2²) b</p> 	<p>(6x1, 2x2¹, 4x2²) c</p> 	<p>(6x1, 2x2¹, 4x2²) d</p> 	<p>(6x1, 6x2²) a</p> 

	<p>(6x1, 6x2²) b</p>	<p>(5x2, 4x2¹)</p>	<p>(5x2, 2x2¹, 2x2²)</p>	<p>(5x2, 4x2²)</p>
	<p>(3x2, 6x2¹) a</p>	<p>(3x2, 6x2¹) b</p>	<p>(3x2, 6x2¹) c</p>	<p>(3x2, 4x2¹, 2x2²) a</p>
	<p>(3x2, 4x2¹, 2x2²) b</p>	<p>(3x2, 4x2¹, 2x2²) c</p>	<p>(3x2, 4x2¹, 2x2²) d</p>	<p>(3x2, 4x2¹, 2x2²) e</p>

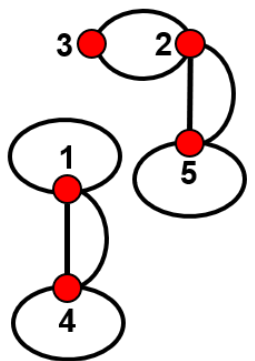
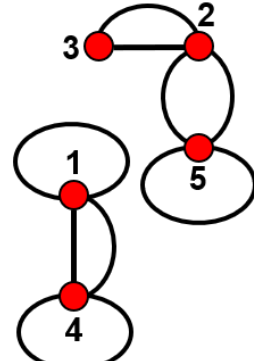
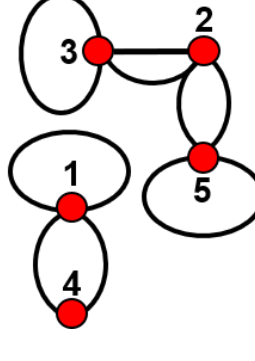
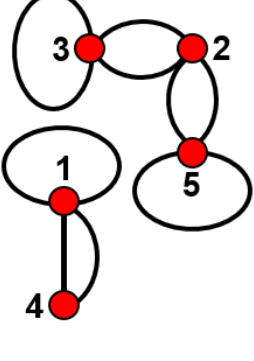
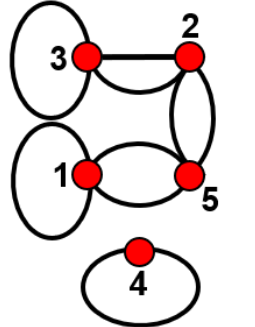
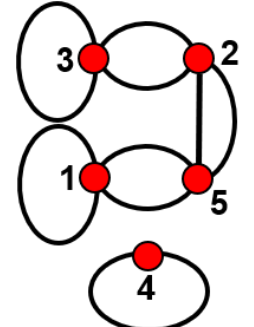
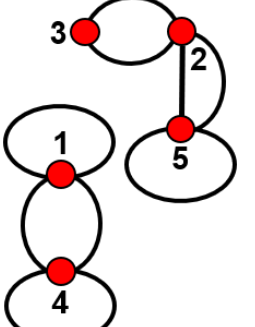
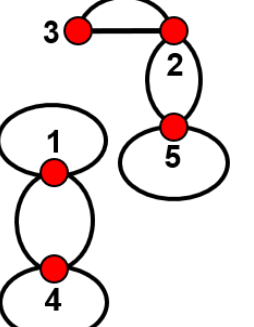
	<p>(3x2, 4x2¹, 2x2²) f</p> 	<p>(3x2, 4x2¹, 2x2²) g</p> 	<p>(3x2, 2x2¹, 4x2²) a</p> 	<p>(3x2, 2x2¹, 4x2²) b</p> 
	<p>(3x2, 2x2¹, 4x2²) c</p> 	<p>(3x2, 2x2¹, 4x2²) d</p> 	<p>(3x2, 2x2¹, 4x2²) e</p> 	<p>(3x2, 2x2¹, 4x2²) f</p> 

	<p>(3x2, 2x2¹, 4x2²) g</p>	<p>(3x2, 6x2²) a</p>	<p>(3x2, 6x2²) b</p>	<p>(3x2, 6x2²) c</p>
	<p>(1x2, 8x2¹) a</p>	<p>(1x2, 8x2¹) b</p>	<p>(1x2, 8x2¹) c</p>	<p>(1x2, 6x2¹, 2x2²) a</p>
	<p>(1x2, 6x2¹, 2x2²) b</p>	<p>(1x2, 6x2¹, 2x2²) c</p>	<p>(1x2, 6x2¹, 2x2²) d</p>	<p>(1x2, 6x2¹, 2x2²) e</p>

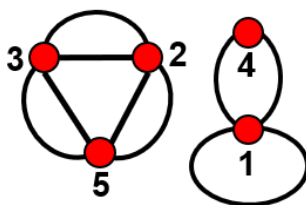
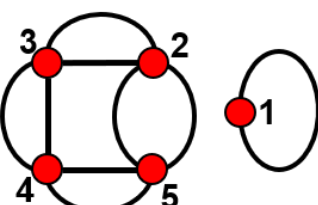
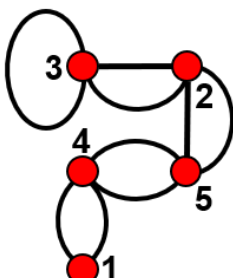
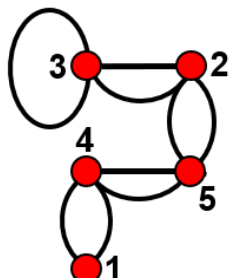
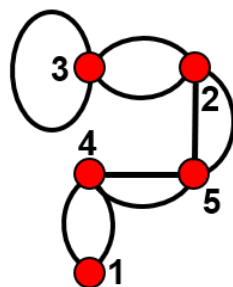
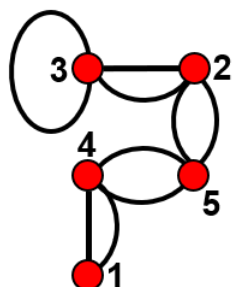
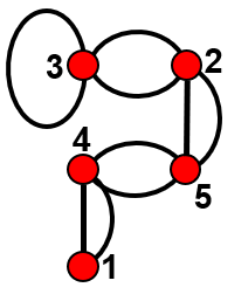
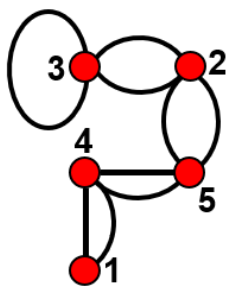
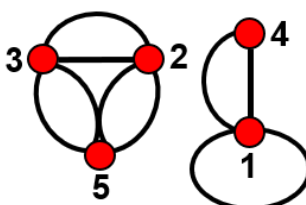
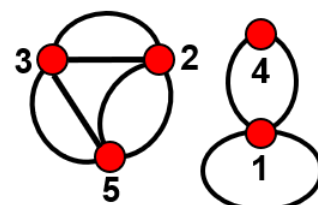
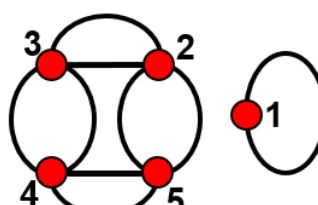
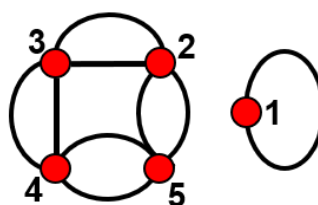
	<p>(1x2, 6x2¹, 2x2²) f</p> 	<p>(1x2, 6x2¹, 2x2²) g</p> 	<p>(1x2, 4x2¹, 4x2²) a</p> 	<p>(1x2, 4x2¹, 4x2²) b</p> 
	<p>(1x2, 4x2¹, 4x2²) c</p> 	<p>(1x2, 4x2¹, 4x2²) d</p> 	<p>(1x2, 4x2¹, 4x2²) e</p> 	<p>(1x2, 4x2¹, 4x2²) f</p> 
	<p>(1x2, 4x2¹, 4x2²) g</p> 	<p>(1x2, 4x2¹, 4x2²) h</p> 	<p>(1x2, 4x2¹, 4x2²) i</p> 	<p>(1x2, 4x2¹, 4x2²) j</p> 

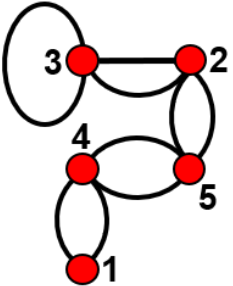
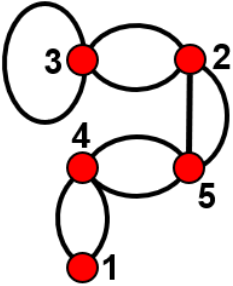
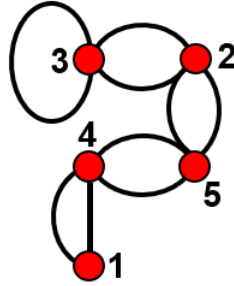
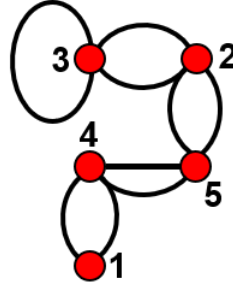
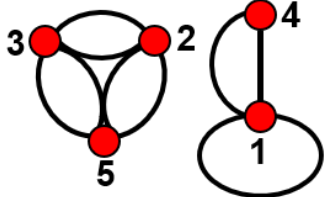
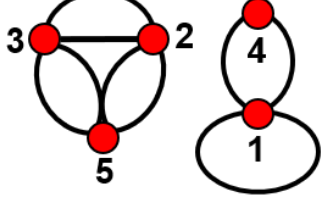
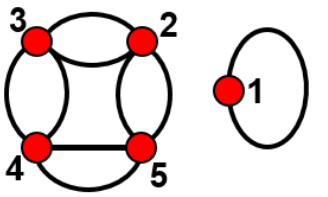
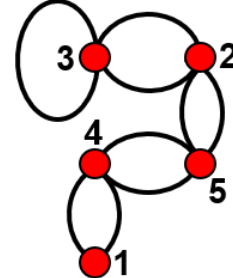
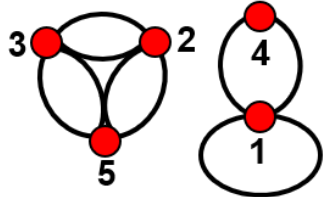
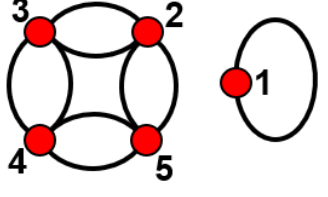
	(1x2, 2x2 ¹ , 6x2 ²) a 	(1x2, 2x2 ¹ , 6x2 ²) b 	(1x2, 2x2 ¹ , 6x2 ²) c 	(1x2, 2x2 ¹ , 6x2 ²) d 
	(1x2, 2x2 ¹ , 6x2 ²) e 	(1x2, 2x2 ¹ , 6x2 ²) f 	(1x2, 2x2 ¹ , 6x2 ²) g 	(1x2, 8x2 ²) a 
	(1x2, 8x2 ²) b 	(1x2, 8x2 ²) c 		
${}^2V_1^4V_5$	NG			
${}^2V_1^4V_6$	NG			
${}^2V_1^4V_7$	NG			

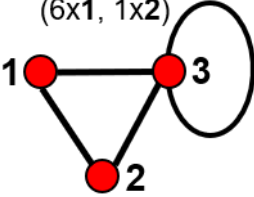
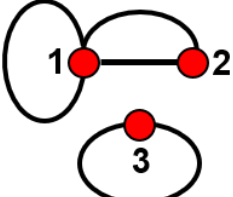
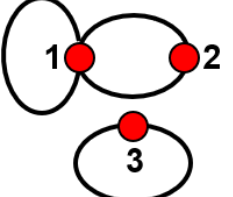
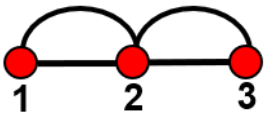
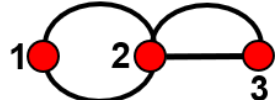
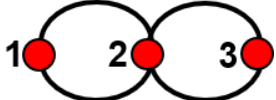
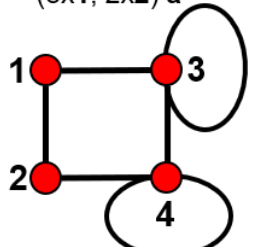
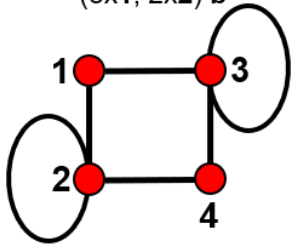
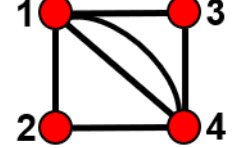
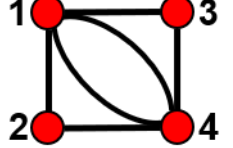
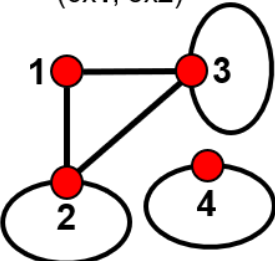
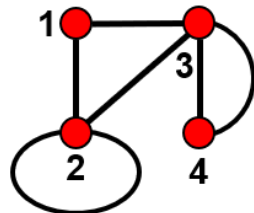
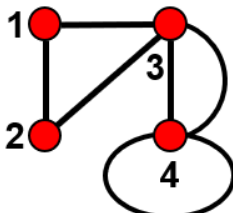
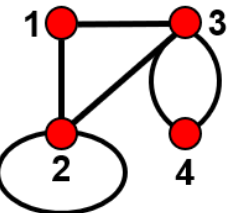
${}^2V_2^4V_1$	<p>(6x1, 1x2)</p> 	<p>(2x2, 2x2¹)</p> 	<p>(2x2, 2x2²)</p> 	<p>(4x2¹)</p> 
	<p>(2x2¹, 2x2²)</p> 	<p>(4x2²)</p> 		
${}^2V_2^4V_2$	<p>(8x1, 2x2) a</p> 	<p>(8x1, 2x2) b</p> 	<p>(8x1, 2x2¹)</p> 	<p>(8x1, 2x2²)</p> 
	<p>(6x1, 3x2)</p> 	<p>(6x1, 1x2, 2x2¹) a</p> 	<p>(6x1, 1x2, 2x2¹) b</p> 	<p>(6x1, 1x2, 2x2²) a</p> 

	<p>(6x1, 1x2, 2x2²) b</p>	<p>(4x2, 2x2¹)</p>	<p>(4x2, 2x2²)</p>	<p>(2x2, 4x2¹) a</p>
	<p>(2x2, 4x2¹) b</p>	<p>(2x2, 4x2¹) c</p>	<p>(2x2, 2x2¹, 2x2²) a</p>	<p>(2x2, 2x2¹, 2x2²) b</p>
	<p>(2x2, 2x2¹, 2x2²) c</p>	<p>(2x2, 2x2¹, 2x2²) d</p>	<p>(2x2, 2x2¹, 2x2²) e</p>	<p>(2x2, 4x2²) a</p>

	<p>(2x2, 4x2²) b</p>	<p>(2x2, 4x2²) c</p>	<p>(6x2¹)</p>	<p>(4x2¹, 2x2²) a</p>
	<p>(4x2¹, 2x2²) b</p>	<p>(2x2¹, 4x2²) a</p>	<p>(2x2¹, 4x2²) b</p>	<p>(6x2²)</p>
${}^2V_2^4V_3$	<p>(14x1, 1x2)</p>	<p>(12x1, 2x2) a</p>	<p>(12x1, 2x2) b</p>	<p>(12x1, 2x2¹)</p>
	<p>(12x1, 2x2²)</p>	<p>(10x1, 3x2) a</p>	<p>(10x1, 3x2) b</p>	<p>(10x1, 1x2, 2x2¹) a</p>

	<p>(10x1, 1x2, 2x2¹) b</p>	<p>(8x1, 4x2)</p>	<p>(8x1, 2x2, 2x2¹) a</p>	<p>(8x1, 2x2, 2x2¹) b</p>
	<p>(8x1, 2x2, 2x2¹) c</p>	<p>(8x1, 2x2, 2x2¹) d</p>	<p>(8x1, 2x2, 2x2¹) e</p>	<p>(8x1, 2x2, 2x2²) a</p>
	<p>(8x1, 2x2, 2x2²) b</p>	<p>(8x1, 2x2, 2x2²) c</p>	<p>(8x1, 2x2, 2x2²) d</p>	<p>(8x1, 2x2, 2x2²) e</p>

	<p>(8x1, 4x2¹) a</p>	<p>(8x1, 4x2¹) b</p>	<p>(8x1, 4x2¹) c</p>	<p>(8x1, 2x2¹, 2x2²) a</p>
	<p>(8x1, 2x2¹, 2x2²) b</p>	<p>(8x1, 2x2¹, 2x2²) c</p>	<p>(8x1, 2x2¹, 2x2²) d</p>	<p>(8x1, 4x2²) a</p>
	<p>(8x1, 4x2²) b</p>	<p>(8x1, 4x2²) c</p>	<p>(6x1, 5x2)</p>	<p>(6x1, 3x2, 2x2¹) a</p>

	<p>(6x1, 3x2, 2x2¹) b</p>	<p>(6x1, 3x2, 2x2¹) c</p>	<p>(6x1, 3x2, 2x2¹) d</p>	<p>(6x1, 3x2, 2x2¹) e</p>
	<p>(6x1, 3x2, 2x2²) a</p>	<p>(6x1, 3x2, 2x2²) b</p>	<p>(6x1, 3x2, 2x2²) c</p>	<p>(6x1, 3x2, 2x2²) d</p>
	<p>(6x1, 3x2, 2x2²) e</p>	<p>(6x1, 1x2, 4x2¹) a</p>	<p>(6x1, 1x2, 4x2¹) b</p>	<p>(6x1, 1x2, 4x2¹) c</p>

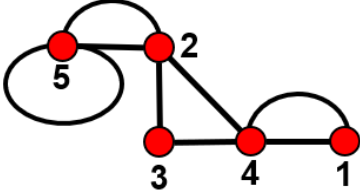
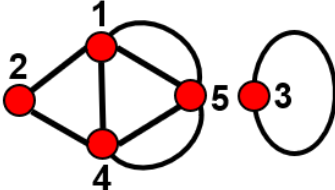
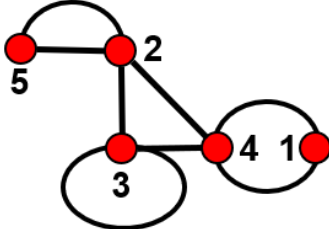
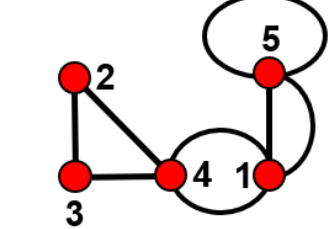
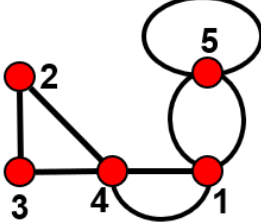
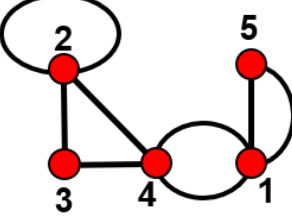
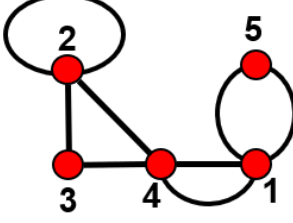
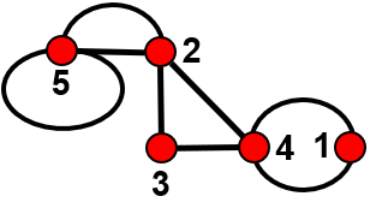
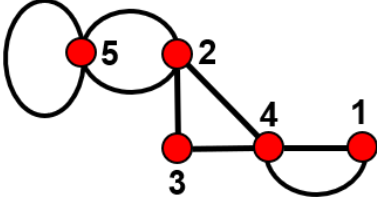
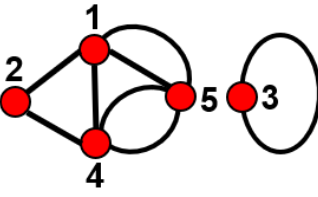
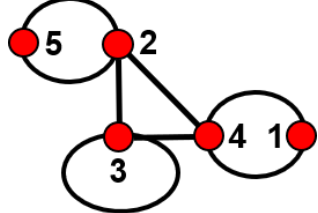
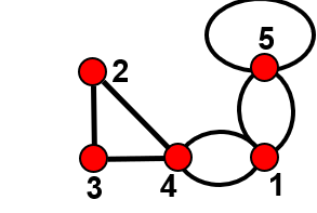
	<p>(6x1, 1x2, 4x2¹) d</p> 	<p>(6x1, 1x2, 4x2¹) e</p> 	<p>(6x1, 1x2, 2x2¹, 2x2²) a</p> 	<p>(6x1, 1x2, 2x2¹, 2x2²) b</p> 
	<p>(6x1, 1x2, 2x2¹, 2x2²) c</p> 	<p>(6x1, 1x2, 2x2¹, 2x2²) d</p> 	<p>(6x1, 1x2, 2x2¹, 2x2²) e</p> 	<p>(6x1, 1x2, 2x2¹, 2x2²) f</p> 
	<p>(6x1, 1x2, 2x2¹, 2x2²) g</p> 	<p>(6x1, 1x2, 2x2¹, 2x2²) h</p> 	<p>(6x1, 1x2, 4x2²) a</p> 	<p>(6x1, 1x2, 4x2²) b</p> 

	<p>(6x1, 1x2, 4x2²) c</p>	<p>(6x1, 1x2, 4x2²) d</p>	<p>(6x1, 1x2, 4x2²) e</p>	<p>(4x2, 4x2¹) a</p>
	<p>(4x2, 4x2¹) b</p>	<p>(4x2, 2x2¹, 2x2²) a</p>	<p>(4x2, 2x2¹, 2x2²) b</p>	<p>(4x2, 2x2¹, 2x2²) c</p>
	<p>(4x2, 4x2²) a</p>	<p>(4x2, 4x2²) b</p>	<p>(2x2, 6x2¹) a</p>	<p>(2x2, 6x2¹) b</p>

	<p>(2x2, 6x2¹) c</p>	<p>(2x2, 6x2¹) d</p>	<p>(2x2, 6x2¹) e</p>	<p>(2x2, 4x2¹, 2x2²) a</p>
	<p>(2x2, 4x2¹, 2x2²) b</p>	<p>(2x2, 4x2¹, 2x2²) c</p>	<p>(2x2, 4x2¹, 2x2²) d</p>	<p>(2x2, 4x2¹, 2x2²) e</p>
	<p>(2x2, 4x2¹, 2x2²) f</p>	<p>(2x2, 4x2¹, 2x2²) g</p>	<p>(2x2, 4x2¹, 2x2²) h</p>	<p>(2x2, 4x2¹, 2x2²) i</p>

	<p>$(2x^2, 4x2^1, 2x2^2)$ j</p>	<p>$(2x^2, 4x2^1, 2x2^2)$ k</p>	<p>$(2x^2, 2x2^1, 4x2^2)$ a</p>	<p>$(2x^2, 2x2^1, 4x2^2)$ b</p>
	<p>$(2x^2, 2x2^1, 4x2^2)$ c</p>	<p>$(2x^2, 2x2^1, 4x2^2)$ d</p>	<p>$(2x^2, 2x2^1, 4x2^2)$ e</p>	<p>$(2x^2, 2x2^1, 4x2^2)$ f</p>
	<p>$(2x^2, 2x2^1, 4x2^2)$ g</p>	<p>$(2x^2, 2x2^1, 4x2^2)$ h</p>	<p>$(2x^2, 2x2^1, 4x2^2)$ i</p>	<p>$(2x^2, 2x2^1, 4x2^2)$ j</p>

	<p>$(2 \times 2, 2 \times 2^1, 4 \times 2^2)$ k</p>	<p>$(2 \times 2, 6 \times 2^2)$ a</p>	<p>$(2 \times 2, 6 \times 2^2)$ b</p>	<p>$(2 \times 2, 6 \times 2^2)$ c</p>
	<p>$(2 \times 2, 6 \times 2^2)$ d</p>	<p>$(2 \times 2, 6 \times 2^2)$ e</p>	<p>(8×2^1) a</p>	<p>(8×2^1) b</p>
	<p>$(6 \times 2^1, 2 \times 2^2)$ a</p>	<p>$(6 \times 2^1, 2 \times 2^2)$ b</p>	<p>$(6 \times 2^1, 2 \times 2^2)$ c</p>	<p>$(6 \times 2^1, 2 \times 2^2)$ d</p>
	<p>$(4 \times 2^1, 4 \times 2^2)$ a</p>	<p>$(4 \times 2^1, 4 \times 2^2)$ b</p>	<p>$(4 \times 2^1, 4 \times 2^2)$ c</p>	<p>$(4 \times 2^1, 4 \times 2^2)$ d</p>

	<p>($4 \times 2^1, 4 \times 2^2$) e</p>	<p>($4 \times 2^1, 4 \times 2^2$) f</p>	<p>($2 \times 2^1, 6 \times 2^2$) a</p>	<p>($2 \times 2^1, 6 \times 2^2$) b</p>
	<p>($2 \times 2^1, 6 \times 2^2$) c</p>	<p>($2 \times 2^1, 6 \times 2^2$) d</p>	<p>(8×2^2) a</p>	<p>(8×2^2) b</p>
${}^2V_2^4V_4$	NG			
${}^2V_2^4V_5$	NG			
${}^2V_2^4V_6$	NG			
${}^2V_3^4V_1$	<p>($8 \times 1, 1 \times 2$)</p>	<p>($6 \times 1, 2 \times 2$)</p>	<p>($6 \times 1, 2 \times 2^1$)</p>	<p>($6 \times 1, 2 \times 2^2$)</p>

	<p>(3x2, 2x2¹)</p>	<p>(3x2, 2x2²)</p>	<p>(1x2, 4x2¹) a</p>	<p>(1x2, 4x2¹) b</p>
	<p>(1x2, 2x2¹, 2x2²) a</p>	<p>(1x2, 2x2¹, 2x2²) b</p>	<p>(1x2, 2x2¹, 2x2²) c</p>	<p>(1x2, 4x2²) a</p>
	<p>(1x2, 4x2²) b</p>			
${}^2V_3^4V_2$	<p>(14x1)</p>	<p>(12x1, 1x2)</p>	<p>(10x1, 2x2) a</p>	<p>(10x1, 2x2) b</p>

	<p>(10x1, 2x2¹)</p>	<p>(10x1, 2x2²)</p>	<p>(8x1, 3x2) a</p>	<p>(8x1, 3x2) b</p>
	<p>(8x1, 1x2, 2x2¹) a</p>	<p>(8x1, 1x2, 2x2¹) b</p>	<p>(8x1, 1x2, 2x2¹) c</p>	<p>(8x1, 1x2, 2x2¹) d</p>
	<p>(8x1, 1x2, 2x2²) a</p>	<p>(8x1, 1x2, 2x2²) b</p>	<p>(8x1, 1x2, 2x2²) c</p>	<p>(8x1, 1x2, 2x2²) d</p>
	<p>(6x1, 4x2)</p>	<p>(6x1, 2x2, 2x2¹) a</p>	<p>(6x1, 2x2, 2x2¹) b</p>	<p>(6x1, 2x2, 2x2¹) c</p>

	<p>(6x1, 2x2, 2x2¹) d</p>	<p>(6x1, 2x2, 2x2¹) e</p>	<p>(6x1, 2x2, 2x2²) a</p>	<p>(6x1, 2x2, 2x2²) b</p>
	<p>(6x1, 2x2, 2x2²) c</p>	<p>(6x1, 2x2, 2x2²) d</p>	<p>(6x1, 2x2, 2x2²) e</p>	<p>(6x1, 4x2¹) a</p>
	<p>(6x1, 4x2¹) b</p>	<p>(6x1, 2x2¹, 2x2²) a</p>	<p>(6x1, 2x2¹, 2x2²) b</p>	<p>(6x1, 2x2¹, 2x2²) c</p>

	<p>(6x1, 4x2²) a</p>	<p>(6x1, 4x2²) b</p>	<p>(5x2, 2x2¹)</p>	<p>(5x2, 2x2²)</p>
	<p>(3x2, 4x2¹) a</p>	<p>(3x2, 4x2¹) b</p>	<p>(3x2, 4x2¹) c</p>	<p>(3x2, 2x2¹, 2x2²) a</p>
	<p>(3x2, 2x2¹, 2x2²) b</p>	<p>(3x2, 2x2¹, 2x2²) c</p>	<p>(3x2, 2x2¹, 2x2²) d</p>	<p>(3x2, 2x2¹, 2x2²) e</p>

	<p>(3x2, 4x2²) a</p>	<p>(3x2, 4x2²) b</p>	<p>(3x2, 4x2²) c</p>	<p>(1x2, 6x2¹) a</p>
	<p>(1x2, 6x2¹) b</p>	<p>(1x2, 6x2¹) c</p>	<p>(1x2, 4x2¹, 2x2²) a</p>	<p>(1x2, 4x2¹, 2x2²) b</p>
	<p>(1x2, 4x2¹, 2x2²) c</p>	<p>(1x2, 4x2¹, 2x2²) d</p>	<p>(1x2, 4x2¹, 2x2²) e</p>	<p>(1x2, 4x2¹, 2x2²) f</p>

	<p>(1x2, 4x2¹, 2x2²) g</p>	<p>(1x2, 2x2¹, 4x2²) a</p>	<p>(1x2, 2x2¹, 4x2²) b</p>	<p>(1x2, 2x2¹, 4x2²) c</p>
	<p>(1x2, 2x2¹, 4x2²) d</p>	<p>(1x2, 2x2¹, 4x2²) e</p>	<p>(1x2, 2x2¹, 4x2²) f</p>	<p>(1x2, 2x2¹, 4x2²) g</p>
	<p>(1x2, 6x2²) a</p>	<p>(1x2, 6x2²) b</p>	<p>(1x2, 6x2²) c</p>	
${}^2V_3^4V_3$	NG			
${}^2V_3^4V_4$	NG			
${}^2V_3^4V_5$	NG			

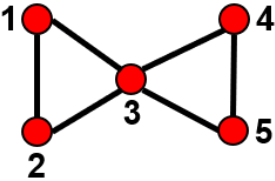
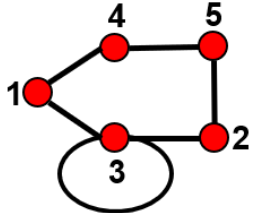
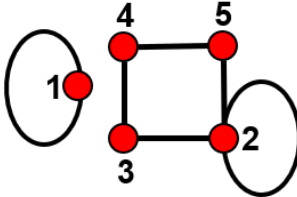
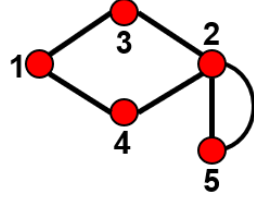
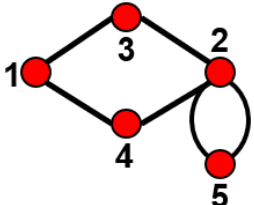
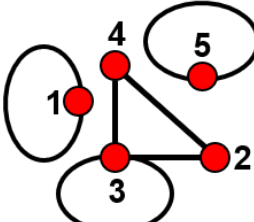
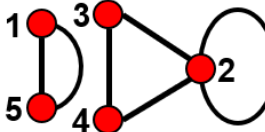
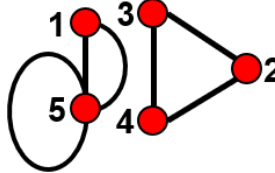
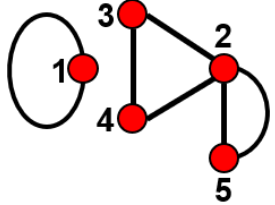
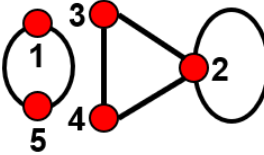
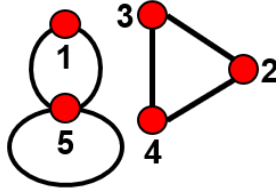
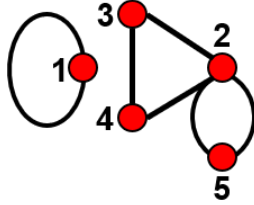
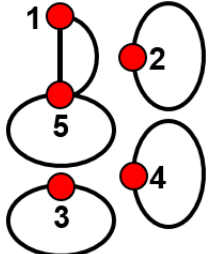
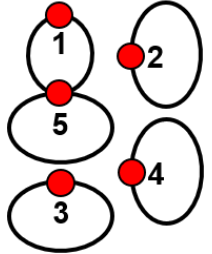
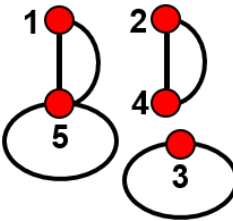
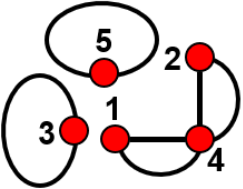
${}^2V_4^4V_1$	<p>(12x1)</p> 	<p>(10x1, 1x2)</p> 	<p>(8x1, 2x2)</p> 	<p>(8x1, 2x2¹)</p> 
	<p>(8x1, 2x2²)</p> 	<p>(6x1, 3x2)</p> 	<p>(6x1, 1x2, 2x2¹) a</p> 	<p>(6x1, 1x2, 2x2¹) b</p> 
	<p>(6x1, 1x2, 2x2²) c</p> 	<p>(6x1, 1x2, 2x2²) a</p> 	<p>(6x1, 1x2, 2x2²) b</p> 	<p>(6x1, 1x2, 2x2²) c</p> 
	<p>(4x2, 2x2¹)</p> 	<p>(4x2, 2x2²)</p> 	<p>(2x2, 4x2¹) a</p> 	<p>(2x2, 4x2¹) b</p> 

	<p>(2x2, 2x2¹, 2x2²) a</p>	<p>(2x2, 2x2¹, 2x2²) b</p>	<p>(2x2, 2x2¹, 2x2²) c</p>	<p>(2x2, 4x2²) a</p>
	<p>(2x2, 4x2²) b</p>	<p>(6x2¹)</p>	<p>(4x2¹, 2x2²) a</p>	<p>(4x2¹, 2x2²) b</p>
	<p>(2x2¹, 4x2²) a</p>	<p>(2x2¹, 4x2²) b</p>	<p>(6x2²)</p>	
${}^2V_4^4V_2$	<p>(16x1) a</p>	<p>(16x1) b</p>	<p>(14x1, 1x2) a</p>	<p>(14x1, 1x2) b</p>

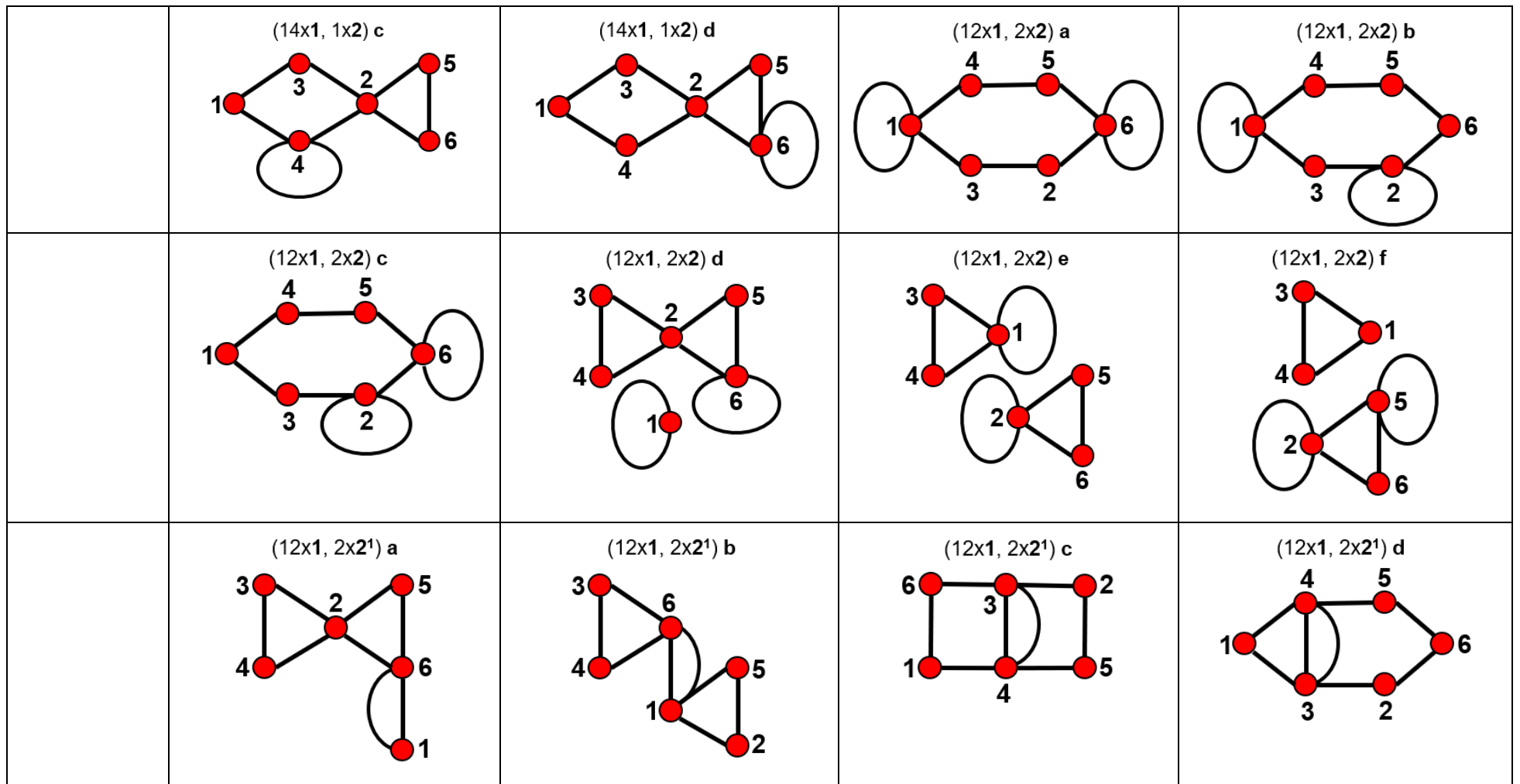

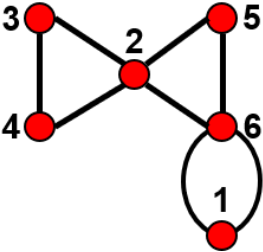
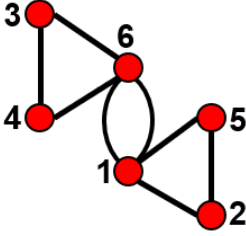
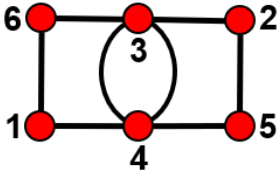
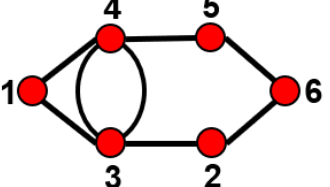
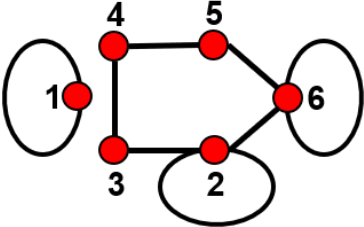
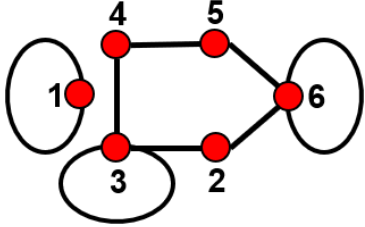
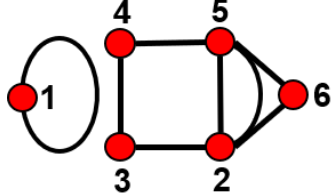
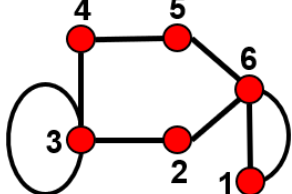
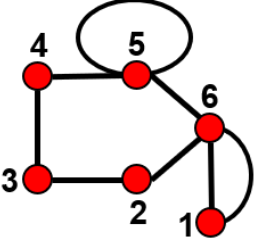
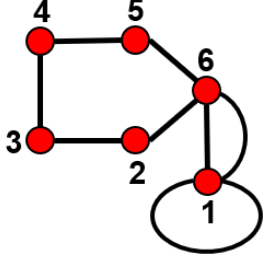
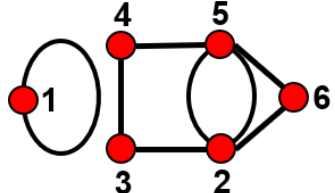
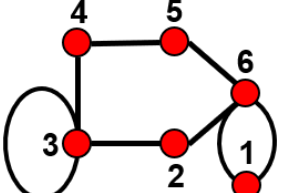
	<p>(12x1, 2x2²) a</p> 	<p>(12x1, 2x2²) b</p> 	<p>(12x1, 2x2²) c</p> 	<p>(12x1, 2x2²) d</p> 
	<p>(10x1, 3x2) a</p> 	<p>(10x1, 3x2) b</p> 	<p>(10x1, 1x2, 2x2¹) a</p> 	<p>(10x1, 1x2, 2x2¹) b</p> 
	<p>(10x1, 1x2, 2x2¹) c</p> 	<p>(10x1, 1x2, 2x2¹) d</p> 	<p>(10x1, 1x2, 2x2²) a</p> 	<p>(10x1, 1x2, 2x2²) b</p> 

	<p>(10x1, 1x2, 2x2²) c</p>	<p>(10x1, 1x2, 2x2²) d</p>	<p>(8x1, 4x2) a</p>	<p>(8x1, 4x2) b</p>
	<p>(8x1, 2x2, 2x2¹) a</p>	<p>(8x1, 2x2, 2x2¹) b</p>	<p>(8x1, 2x2, 2x2¹) c</p>	<p>(8x1, 2x2, 2x2¹) d</p>
	<p>(8x1, 2x2, 2x2¹) e</p>	<p>(8x1, 2x2, 2x2¹) f</p>	<p>(8x1, 2x2, 2x2¹) g</p>	<p>(8x1, 2x2, 2x2¹) h</p>

	<p>(8x1, 2x2, 2x2²) a</p>	<p>(8x1, 2x2, 2x2²) b</p>	<p>(8x1, 2x2, 2x2²) c</p>	<p>(8x1, 2x2, 2x2²) d</p>
	<p>(8x1, 2x2, 2x2²) e</p>	<p>(8x1, 2x2, 2x2²) f</p>	<p>(8x1, 2x2, 2x2²) g</p>	<p>(8x1, 2x2, 2x2²) h</p>
	<p>(8x1, 4x2¹) a</p>	<p>(8x1, 4x2¹) b</p>	<p>(8x1, 4x2¹) c</p>	<p>(8x1, 4x2¹) d</p>

	<p>($8x1, 2x2^1, 2x2^2$) a</p>	<p>($8x1, 2x2^1, 2x2^2$) b</p>	<p>($8x1, 2x2^1, 2x2^2$) c</p>	<p>($8x1, 2x2^1, 2x2^2$) d</p>
	<p>($8x1, 2x2^1, 2x2^2$) e</p>	<p>($8x1, 2x2^1, 2x2^2$) f</p>	<p>($8x1, 4x2^2$) a</p>	<p>($8x1, 4x2^2$) b</p>
	<p>($8x1, 4x2^2$) c</p>	<p>($8x1, 4x2^2$) d</p>	<p>($6x1, 5x2$)</p>	<p>($6x1, 3x2, 2x2^1$) a</p>

	<p>(6x1, 3x2, 2x2¹) b</p>	<p>(6x1, 3x2, 2x2¹) c</p>	<p>(6x1, 3x2, 2x2¹) d</p>	<p>(6x1, 3x2, 2x2¹) e</p>
	<p>(6x1, 3x2, 2x2²) a</p>	<p>(6x1, 3x2, 2x2²) b</p>	<p>(6x1, 3x2, 2x2²) c</p>	<p>(6x1, 3x2, 2x2²) d</p>
	<p>(6x1, 3x2, 2x2²) e</p>	<p>(6x1, 1x2, 4x2¹) a</p>	<p>(6x1, 1x2, 4x2¹) b</p>	<p>(6x1, 1x2, 4x2¹) c</p>

	<p>(6x1, 1x2, 4x2¹) d</p>	<p>(6x1, 1x2, 4x2¹) e</p>	<p>(6x1, 1x2, 4x2¹) f</p>	<p>(6x1, 1x2, 4x2¹) g</p>
	<p>(6x1, 1x2, 2x2¹, 2x2²) a</p>	<p>(6x1, 1x2, 2x2¹, 2x2²) b</p>	<p>(6x1, 1x2, 2x2¹, 2x2²) c</p>	<p>(6x1, 1x2, 2x2¹, 2x2²) d</p>
	<p>(6x1, 1x2, 2x2¹, 2x2²) e</p>	<p>(6x1, 1x2, 2x2¹, 2x2²) f</p>	<p>(6x1, 1x2, 2x2¹, 2x2²) g</p>	<p>(6x1, 1x2, 2x2¹, 2x2²) h</p>

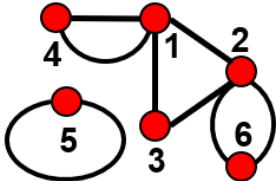
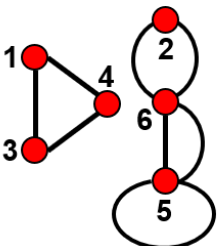
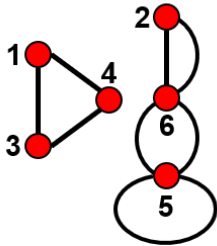
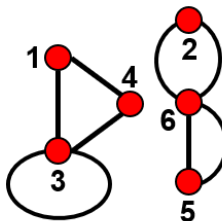
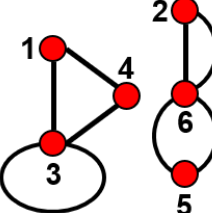
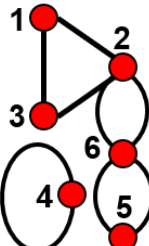
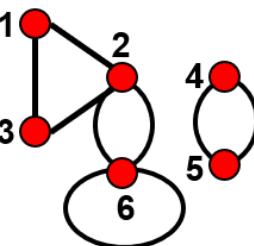
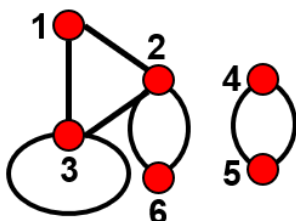
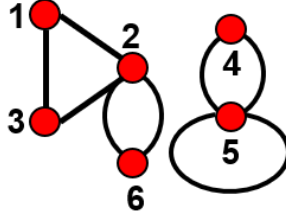
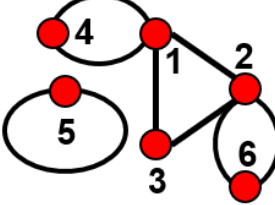
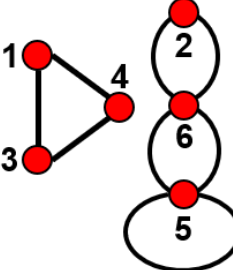
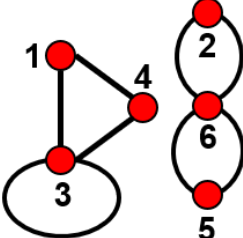
	<p>(6x1, 1x2, 2x2¹, 2x2²) i</p> 	<p>(6x1, 1x2, 2x2¹, 2x2²) j</p> 	<p>(6x1, 1x2, 2x2¹, 2x2²) k</p> 	<p>(6x1, 1x2, 2x2¹, 2x2²) l</p> 
	<p>(6x1, 1x2, 2x2¹, 2x2²) m</p> 	<p>(6x1, 1x2, 4x2²) a</p> 	<p>(6x1, 1x2, 4x2²) b</p> 	<p>(6x1, 1x2, 4x2²) c</p> 
	<p>(6x1, 1x2, 4x2²) d</p> 	<p>(6x1, 1x2, 4x2²) e</p> 	<p>(6x1, 1x2, 4x2²) f</p> 	<p>(6x1, 1x2, 4x2²) g</p> 

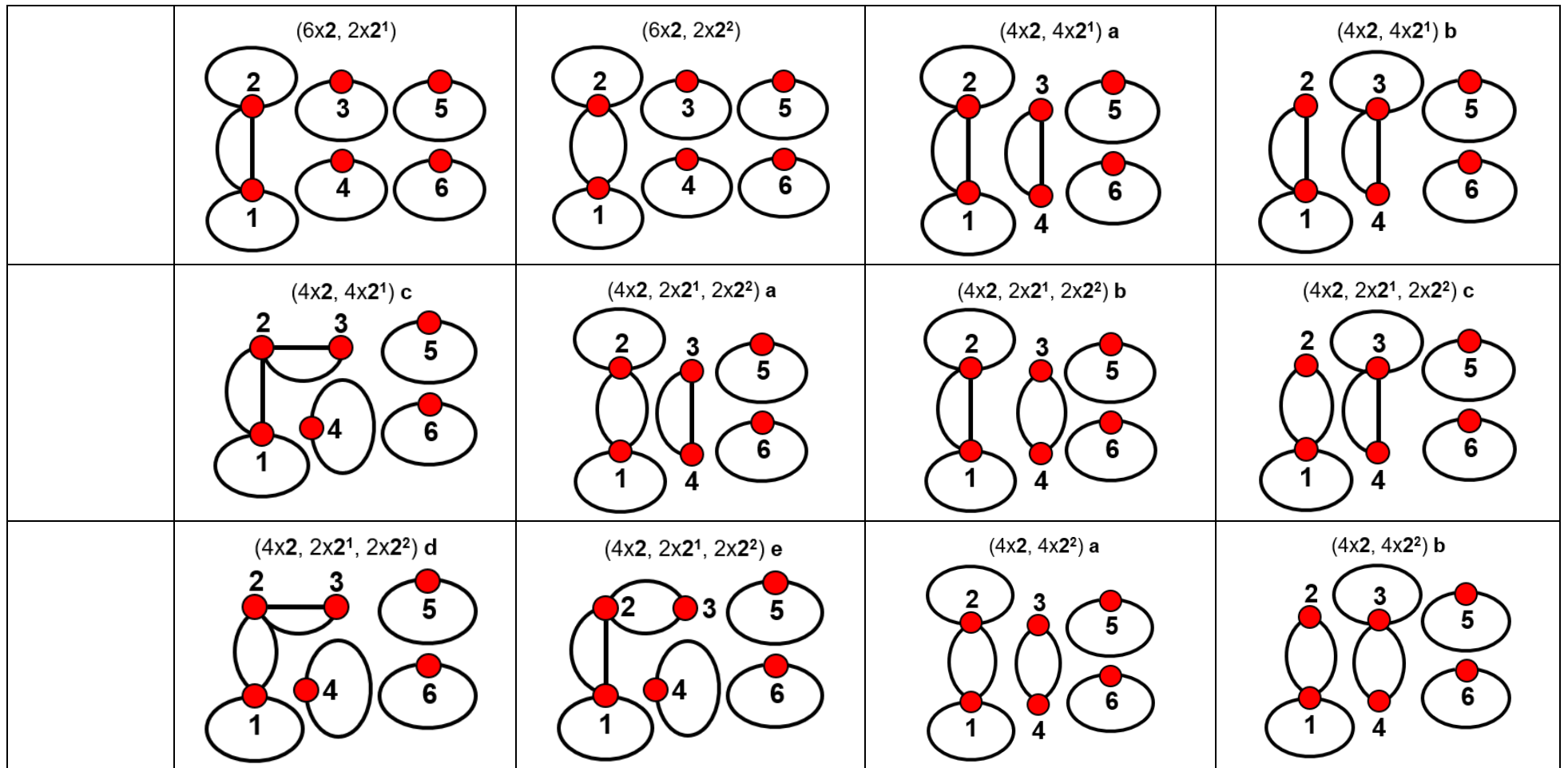

	<p>($4x2, 4x2^2$) c</p>	<p>($2x2, 6x2^1$) a</p>	<p>($2x2, 6x2^1$) b</p>	<p>($2x2, 6x2^1$) c</p>
	<p>($2x2, 6x2^1$) d</p>	<p>($2x2, 6x2^1$) e</p>	<p>($2x2, 4x2^1, 2x2^2$) a</p>	<p>($2x2, 4x2^1, 2x2^2$) b</p>
	<p>($2x2, 4x2^1, 2x2^2$) c</p>	<p>($2x2, 4x2^1, 2x2^2$) d</p>	<p>($2x2, 4x2^1, 2x2^2$) e</p>	<p>($2x2, 4x2^1, 2x2^2$) f</p>

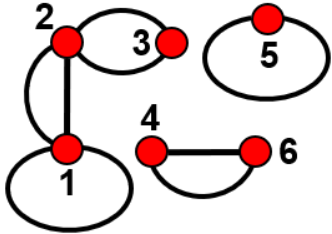
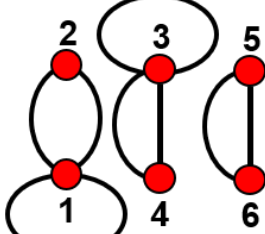
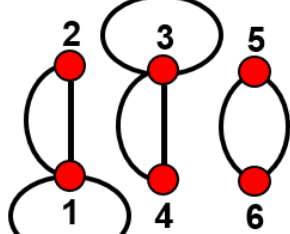
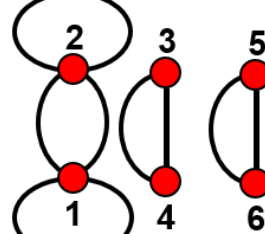
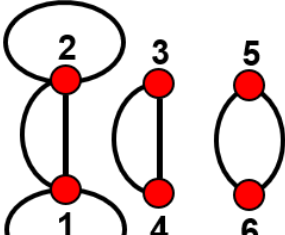
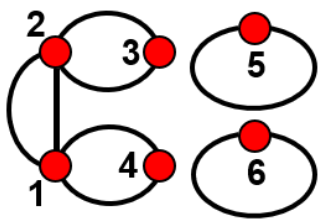
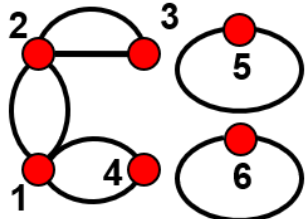
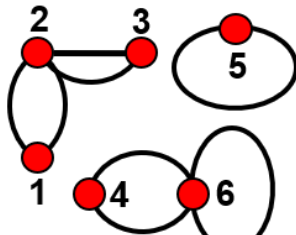
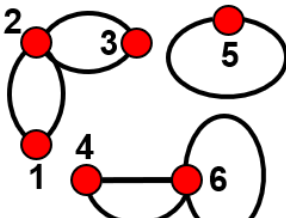
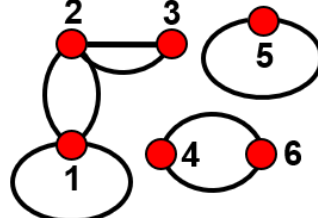
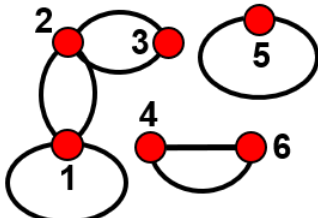
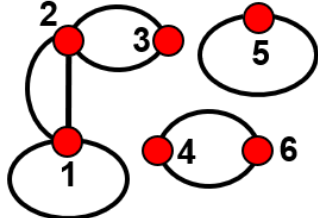
	<p>($2x^2, 4x2^1, 2x2^2$) g</p> 	<p>($2x^2, 4x2^1, 2x2^2$) h</p> 	<p>($2x^2, 4x2^1, 2x2^2$) i</p> 	<p>($2x^2, 4x2^1, 2x2^2$) j</p> 
	<p>($2x^2, 4x2^1, 2x2^2$) k</p> 	<p>($2x^2, 2x2^1, 4x2^2$) a</p> 	<p>($2x^2, 2x2^1, 4x2^2$) b</p> 	<p>($2x^2, 2x2^1, 4x2^2$) c</p> 
	<p>($2x^2, 2x2^1, 4x2^2$) d</p> 	<p>($2x^2, 2x2^1, 4x2^2$) e</p> 	<p>($2x^2, 2x2^1, 4x2^2$) f</p> 	<p>($2x^2, 2x2^1, 4x2^2$) g</p> 

	<p>$(2x2, 2x2^1, 4x2^2)$ h</p>	<p>$(2x2, 2x2^1, 4x2^2)$ i</p>	<p>$(2x2, 2x2^1, 4x2^2)$ j</p>	<p>$(2x2, 2x2^1, 4x2^2)$ k</p>
	<p>$(2x2, 6x2^2)$ a</p>	<p>$(2x2, 6x2^2)$ b</p>	<p>$(2x2, 6x2^2)$ c</p>	<p>$(2x2, 6x2^2)$ d</p>
	<p>$(2x2, 6x2^2)$ e</p>	<p>$(8x2^1)$ a</p>	<p>$(8x2^1)$ b</p>	<p>$(6x2^1, 2x2^2)$ a</p>

	<p>($6x2^1, 2x2^2$) b</p>	<p>($6x2^1, 2x2^2$) c</p>	<p>($6x2^1, 2x2^2$) d</p>	<p>($4x2^1, 4x2^2$) a</p>
	<p>($4x2^1, 4x2^2$) b</p>	<p>($4x2^1, 4x2^2$) c</p>	<p>($4x2^1, 4x2^2$) d</p>	<p>($4x2^1, 4x2^2$) e</p>
	<p>($4x2^1, 4x2^2$) f</p>	<p>($2x2^1, 6x2^2$) a</p>	<p>($2x2^1, 6x2^2$) b</p>	<p>($2x2^1, 6x2^2$) c</p>

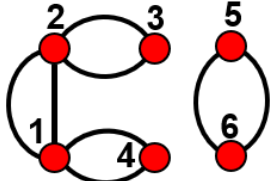
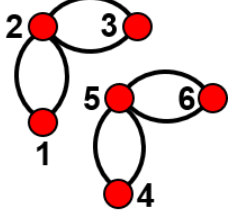
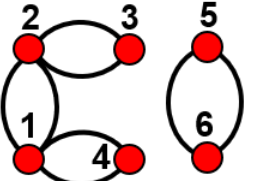
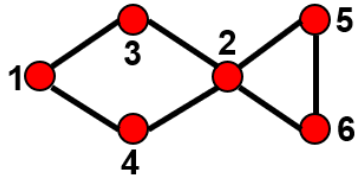
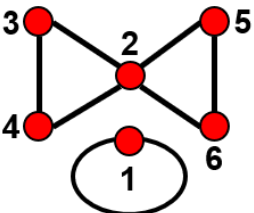
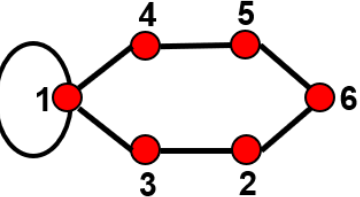
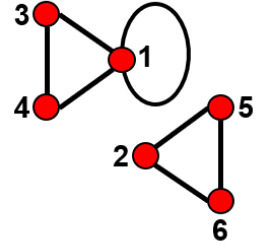
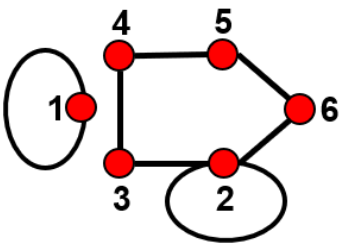
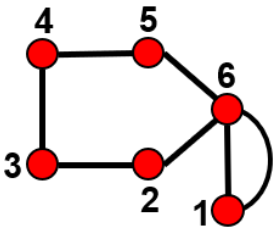
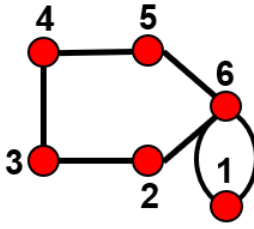
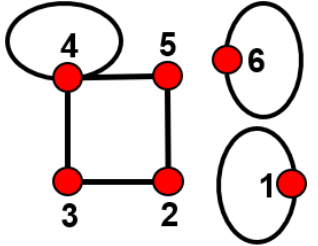
	(2x2 ¹ , 6x2 ²) d 	(8x2 ²) a 	(8x2 ²) b 	
² V ₄ ⁴ V ₃	NG			
² V ₄ ⁴ V ₄	NG			
² V ₅ ⁴ V ₁	(14x1) 	(12x1, 1x2) a 	(12x1, 1x2) b 	(12x1, 1x2) c 
	(10x1, 2x2) 	(10x1, 2x2 ¹) 	(10x1, 2x2 ²) 	(8x1, 3x2) 

	<p>(8x1, 1x2, 2x2¹) a</p>	<p>(8x1, 1x2, 2x2¹) b</p>	<p>(8x1, 1x2, 2x2¹) c</p>	<p>(8x1, 1x2, 2x2²) a</p>
	<p>(8x1, 1x2, 2x2²) b</p>	<p>(8x1, 1x2, 2x2²) c</p>	<p>(6x1, 4x2)</p>	<p>(6x1, 2x2, 2x2¹) a</p>
	<p>(6x1, 2x2, 2x2¹) b</p>	<p>(6x1, 2x2, 2x2¹) c</p>	<p>(6x1, 2x2, 2x2²) a</p>	<p>(6x1, 2x2, 2x2²) b</p>

	<p>(6x1, 2x2, 2x2²) c</p>	<p>(6x1, 4x2¹) a</p>	<p>(6x1, 4x2¹) b</p>	<p>(6x1, 2x2¹, 2x2²) a</p>
	<p>(6x1, 2x2¹, 2x2²) b</p>	<p>(6x1, 2x2¹, 2x2²) c</p>	<p>(6x1, 4x2²) a</p>	<p>(6x1, 4x2²) b</p>
	<p>(5x2, 2x2¹)</p>	<p>(5x2, 2x2²)</p>	<p>(3x2, 4x2¹) a</p>	<p>(3x2, 4x2¹) b</p>

	<p>(3x2, 2x2¹, 2x2²) a</p>	<p>(3x2, 2x2¹, 2x2²) b</p>	<p>(3x2, 2x2¹, 2x2²) c</p>	<p>(3x2, 4x2²) a</p>
	<p>(3x2, 4x2²) b</p>	<p>(1x2, 6x2¹) a</p>	<p>(1x2, 6x2¹) b</p>	<p>(1x2, 4x2¹, 2x2²) a</p>
	<p>(1x2, 4x2¹, 2x2²) b</p>	<p>(1x2, 4x2¹, 2x2²) c</p>	<p>(1x2, 4x2¹, 2x2²) d</p>	<p>(1x2, 2x2¹, 4x2²) a</p>

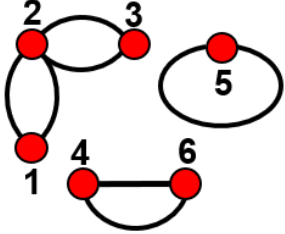
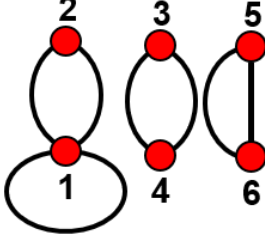
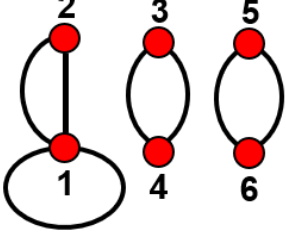
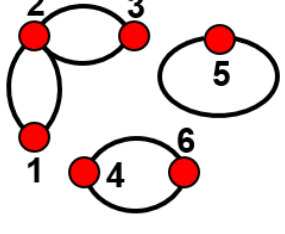
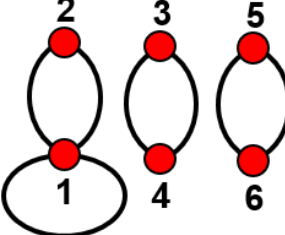
	<p>(1x2, 2x2¹, 4x2²) b</p> 	<p>(1x2, 2x2¹, 4x2²) c</p> 	<p>(1x2, 2x2¹, 4x2²) d</p> 	<p>(1x2, 6x2²) a</p> 
	<p>(1x2, 6x2²) b</p> 			
${}^2V_5^4V_2$	NG			
${}^2V_5^4V_3$	NG			
${}^2V_6^4V_1$	NG			
${}^2V_6^4V_2$	NG			
${}^2V_7^4V_1$	NG			
${}^3V_r^4V_r$				

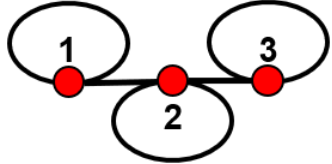
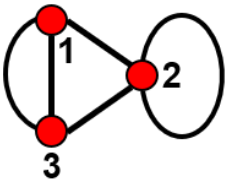
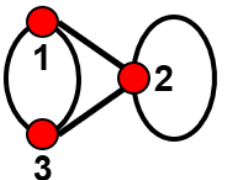
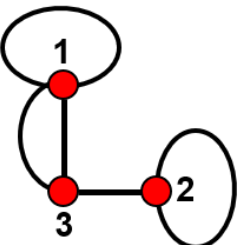
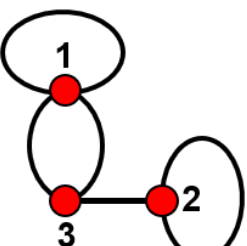
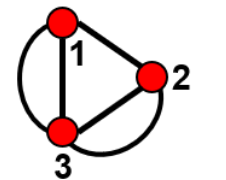
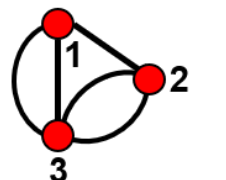
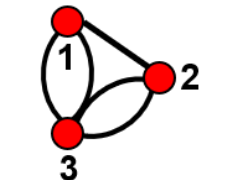
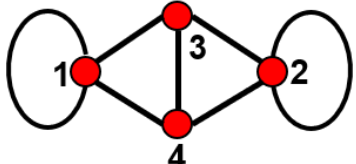
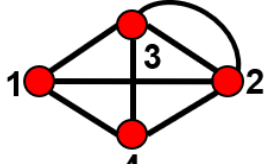
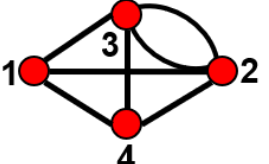
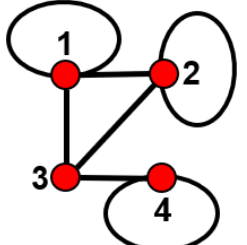
${}^3V_2^4V_1$	<p>(4x1, 3x2)</p> 	<p>(4x1, 1x2, 2x2¹)</p> 	<p>(4x1, 1x2, 2x2²)</p> 	<p>(2x1, 2x2, 2x2¹)</p> 
	<p>(2x1, 2x2, 2x2²)</p> 	<p>(2x1, 4x2¹)</p> 	<p>(2x1, 2x2¹, 2x2²)</p> 	<p>(2x1, 4x2²)</p> 
${}^3V_2^4V_2$	<p>(10x1, 2x2)</p> 	<p>(10x1, 2x2¹)</p> 	<p>(10x1, 2x2²)</p> 	<p>(8x1, 3x2)</p> 

	<p>(8x1, 1x2, 2x2¹)</p>	<p>(8x1, 1x2, 2x2²)</p>	<p>(6x1, 4x2)</p>	<p>(6x1, 2x2, 2x2¹) a</p>
	<p>(6x1, 2x2, 2x2¹) b</p>	<p>(6x1, 2x2, 2x2²) a</p>	<p>(6x1, 2x2, 2x2²) b</p>	<p>(6x1, 4x2¹)</p>
	<p>(6x1, 2x2¹, 2x2²)</p>	<p>(6x1, 4x2²)</p>	<p>(4x1, 3x2, 2x2¹) a</p>	<p>(4x1, 3x2, 2x2¹) b</p>

	<p>$(4x1, 3x2, 2x2^2)$ a</p>	<p>$(4x1, 3x2, 2x2^2)$ b</p>	<p>$(4x1, 1x2, 4x2^1)$ a</p>	<p>$(4x1, 1x2, 4x2^1)$ b</p>
	<p>$(4x1, 1x2, 4x2^1)$ c</p>	<p>$(4x1, 1x2, 2x2^1, 2x2^2)$ a</p>	<p>$(4x1, 1x2, 2x2^1, 2x2^2)$ b</p>	<p>$(4x1, 1x2, 2x2^1, 2x2^2)$ c</p>
	<p>$(4x1, 1x2, 2x2^1, 2x2^2)$ d</p>	<p>$(4x1, 1x2, 2x2^1, 2x2^2)$ e</p>	<p>$(4x1, 1x2, 4x2^2)$ a</p>	<p>$(4x1, 1x2, 4x2^2)$ b</p>

	<p>$(4x1, 1x2, 4x2^2)$ c</p>	<p>$(2x1, 4x2, 2x2^1)$</p>	<p>$(2x1, 4x2, 2x2^2)$</p>	<p>$(2x1, 2x2, 4x2^1)$ a</p>
	<p>$(2x1, 2x2, 4x2^1)$ b</p>	<p>$(2x1, 2x2, 2x2^1, 2x2^2)$ a</p>	<p>$(2x1, 2x2, 2x2^1, 2x2^2)$ b</p>	<p>$(2x1, 2x2, 2x2^1, 2x2^2)$ c</p>
	<p>$(2x1, 2x2, 4x2^2)$ a</p>	<p>$(2x1, 2x2, 4x2^2)$ b</p>	<p>$(2x1, 6x2^1)$</p>	<p>$(2x1, 4x2^1, 2x2^2)$ a</p>
	<p>$(2x1, 4x2^1, 2x2^2)$ b</p>	<p>$(2x1, 2x2^1, 4x2^2)$ a</p>	<p>$(2x1, 2x2^1, 4x2^2)$ b</p>	<p>$(2x1, 6x2^2)$</p>

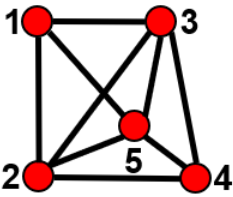
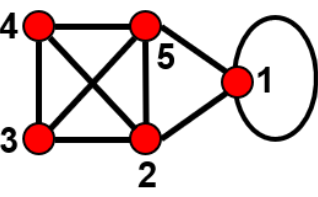
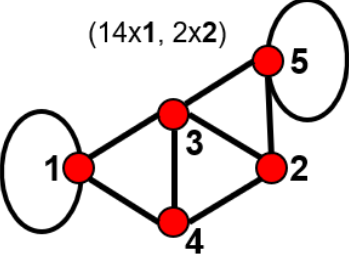
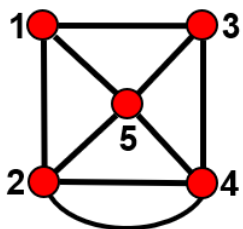
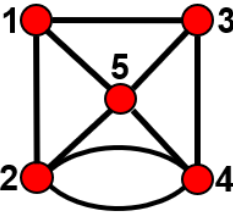
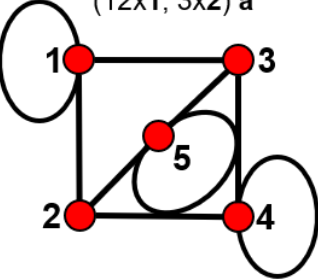
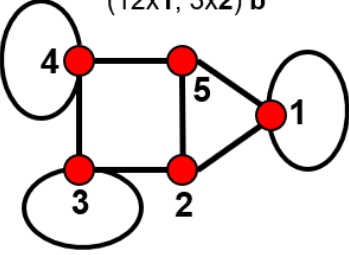
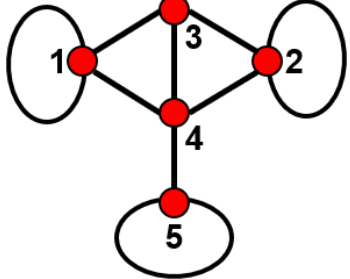
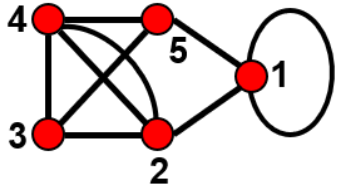
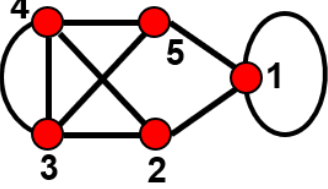
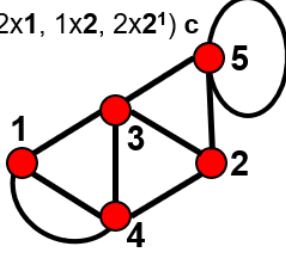
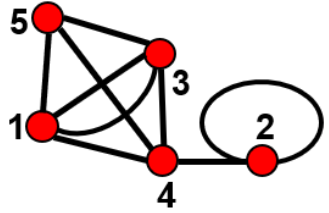
${}^3V_2^4V_3$	<p>(18x1)</p> 	<p>(16x1, 1x2)</p> 	<p>(14x1, 2x2)</p> 	<p>(14x1, 2x2¹)</p> 
	<p>(14x1, 2x2²)</p> 	<p>(12x1, 3x2) a</p> 	<p>(12x1, 3x2) b</p> 	<p>(12x1, 3x2) c</p> 
	<p>(12x1, 1x2, 2x2¹) a</p> 	<p>(12x1, 1x2, 2x2¹) b</p> 	<p>(12x1, 1x2, 2x2¹) c</p> 	<p>(12x1, 1x2, 2x2¹) d</p> 

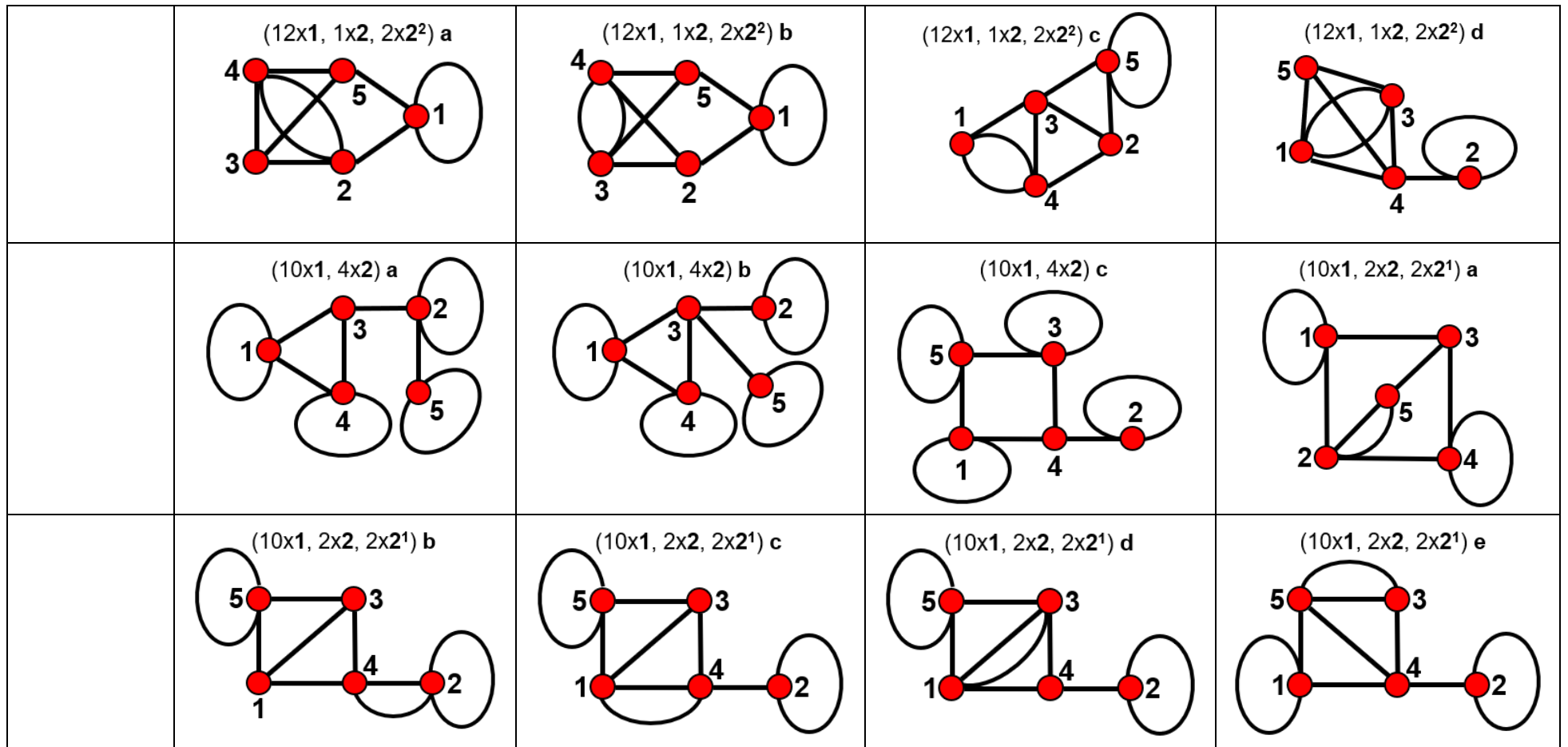

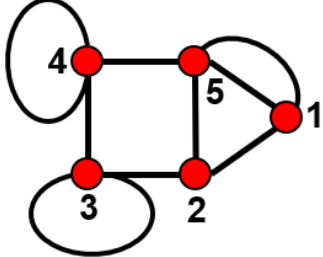
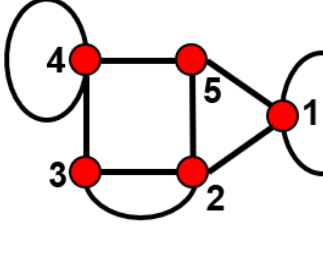
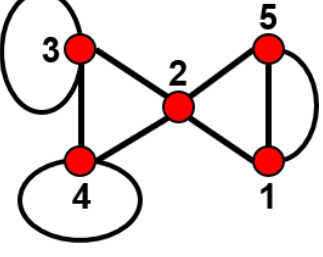
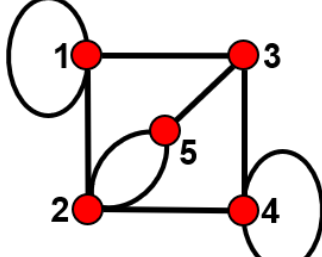
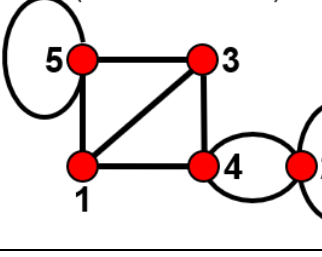
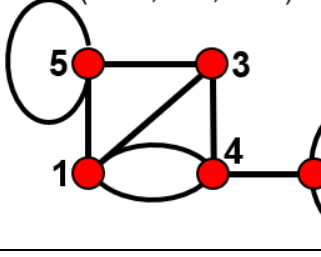
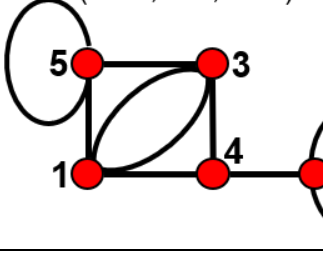
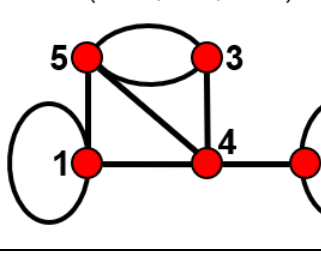
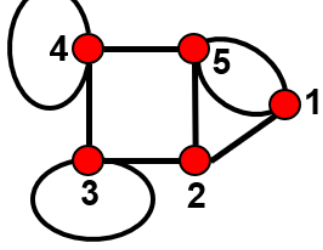
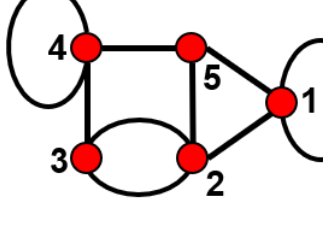
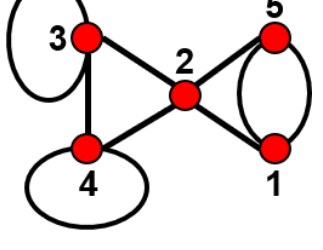
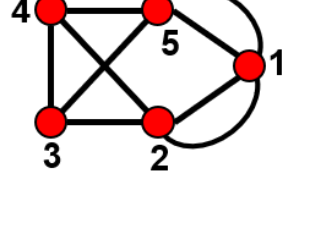
	(10x1, 2x2, 2x2 ¹) f 	(10x1, 2x2, 2x2 ¹) g 	(10x1, 2x2, 2x2 ¹) h 	(10x1, 2x2, 2x2 ²) a 
	(10x1, 2x2, 2x2 ²) b 	(10x1, 2x2, 2x2 ²) c 	(10x1, 2x2, 2x2 ²) d 	(10x1, 2x2, 2x2 ²) e 
	(10x1, 2x2, 2x2 ²) f 	(10x1, 2x2, 2x2 ²) g 	(10x1, 2x2, 2x2 ²) h 	(10x1, 4x2 ¹) a 

	<p>(10x1, 4x2¹) b</p>	<p>(10x1, 4x2¹) c</p>	<p>(10x1, 4x2¹) d</p>	<p>(10x1, 2x2¹, 2x2²) a</p>
	<p>(10x1, 2x2¹, 2x2²) b</p>	<p>(10x1, 2x2¹, 2x2²) c</p>	<p>(10x1, 2x2¹, 2x2²) d</p>	<p>(10x1, 2x2¹, 2x2²) e</p>
	<p>(10x1, 2x2¹, 2x2²) f</p>	<p>(10x1, 4x2²) a</p>	<p>(10x1, 4x2²) b</p>	<p>(10x1, 4x2²) c</p>
	<p>(10x1, 4x2²) d</p>	<p>(8x1, 5x2) a</p>	<p>(8x1, 5x2) b</p>	<p>(8x1, 3x2, 2x2¹) a</p>

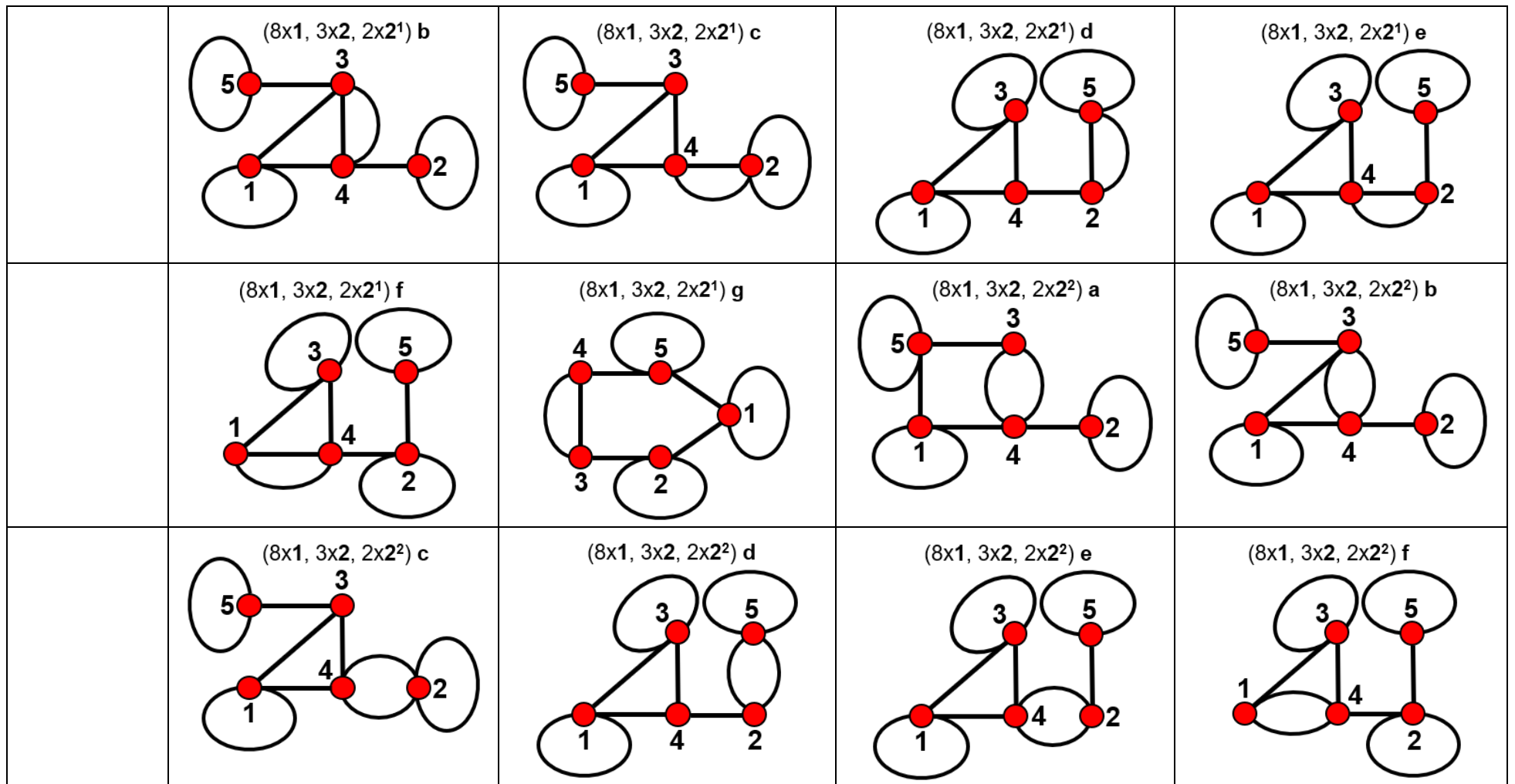

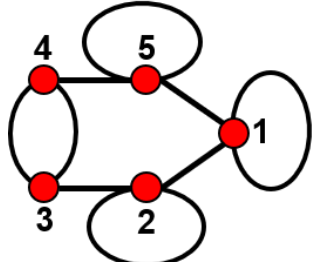
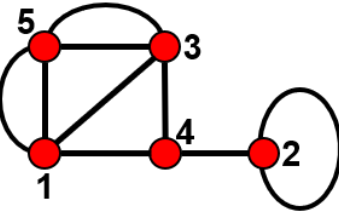
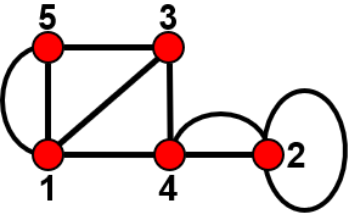
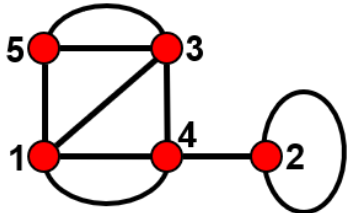
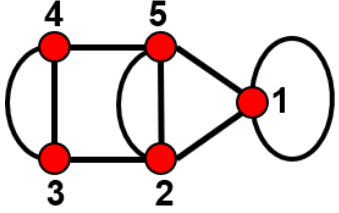
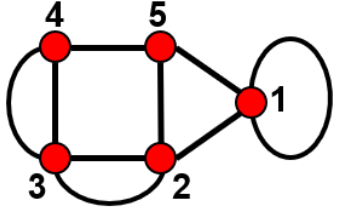
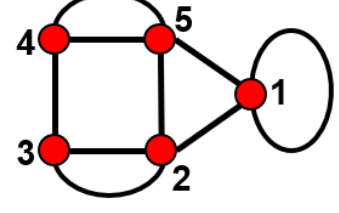
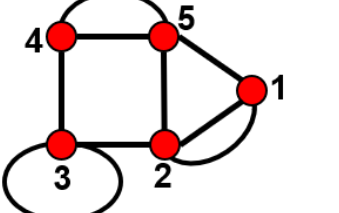
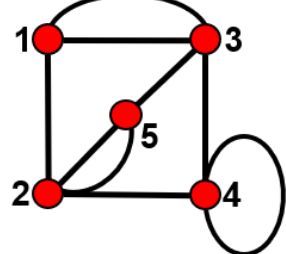
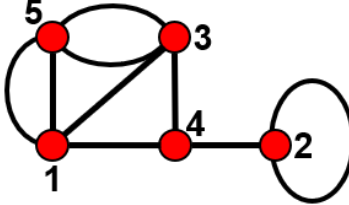
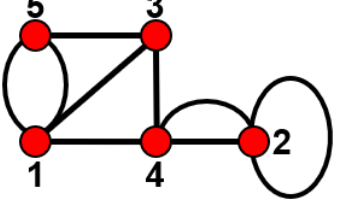
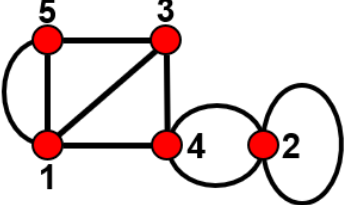
	<p>($8x^1, 3x^2, 2x^{2^2}$) g</p> 	<p>($8x^1, 1x^2, 4x^{2^1}$) a</p> 	<p>($8x^1, 1x^2, 4x^{2^1}$) b</p> 	<p>($8x^1, 1x^2, 4x^{2^1}$) c</p> 
	<p>($8x^1, 1x^2, 4x^{2^1}$) d</p> 	<p>($8x^1, 1x^2, 4x^{2^1}$) e</p> 	<p>($8x^1, 1x^2, 4x^{2^1}$) f</p> 	<p>($8x^1, 1x^2, 4x^{2^1}$) g</p> 
	<p>($8x^1, 1x^2, 4x^{2^1}$) h</p> 	<p>($8x^1, 1x^2, 2x^{2^1}, 2x^{2^2}$) a</p> 	<p>($8x^1, 1x^2, 2x^{2^1}, 2x^{2^2}$) b</p> 	<p>($8x^1, 1x^2, 2x^{2^1}, 2x^{2^2}$) c</p> 

	<p>$(8x^1, 1x^2, 2x^{2^1}, 2x^{2^2})$ d</p>	<p>$(8x^1, 1x^2, 2x^{2^1}, 2x^{2^2})$ e</p>	<p>$(8x^1, 1x^2, 2x^{2^1}, 2x^{2^2})$ f</p>	<p>$(8x^1, 1x^2, 2x^{2^1}, 2x^{2^2})$ g</p>
	<p>$(8x^1, 1x^2, 2x^{2^1}, 2x^{2^2})$ h</p>	<p>$(8x^1, 1x^2, 2x^{2^1}, 2x^{2^2})$ i</p>	<p>$(8x^1, 1x^2, 2x^{2^1}, 2x^{2^2})$ j</p>	<p>$(8x^1, 1x^2, 2x^{2^1}, 2x^{2^2})$ k</p>
	<p>$(8x^1, 1x^2, 2x^{2^1}, 2x^{2^2})$ l</p>	<p>$(8x^1, 1x^2, 2x^{2^1}, 2x^{2^2})$ m</p>	<p>$(8x^1, 1x^2, 2x^{2^1}, 2x^{2^2})$ n</p>	<p>$(8x^1, 1x^2, 4x^{2^2})$ a</p>
	<p>$(8x^1, 1x^2, 4x^{2^2})$ b</p>	<p>$(8x^1, 1x^2, 4x^{2^2})$ c</p>	<p>$(8x^1, 1x^2, 4x^{2^2})$ d</p>	<p>$(8x^1, 1x^2, 4x^{2^2})$ e</p>

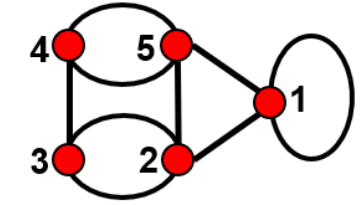
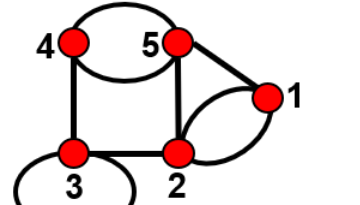
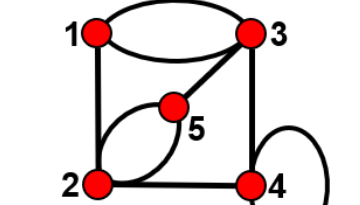
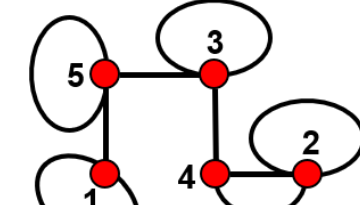
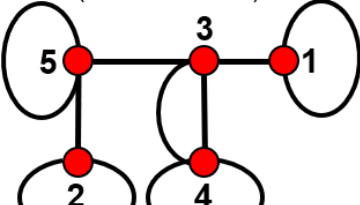
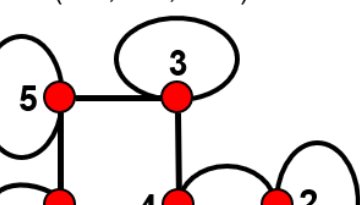
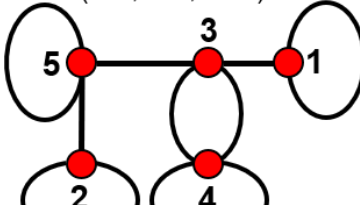
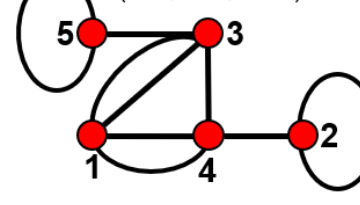
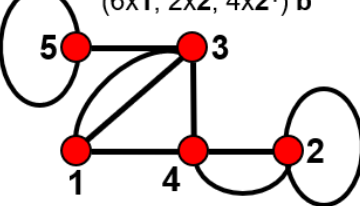
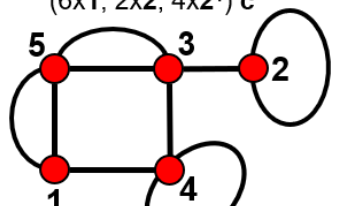
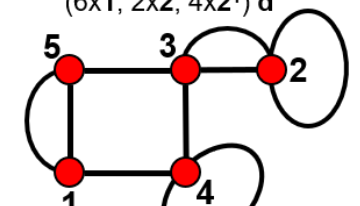
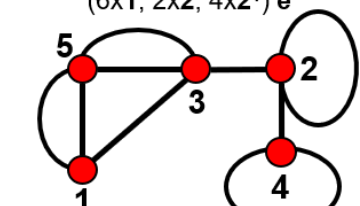
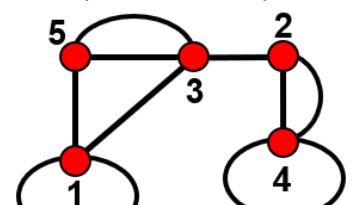
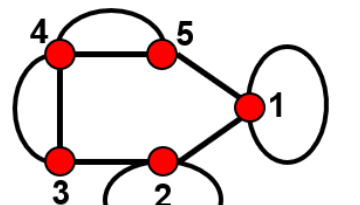
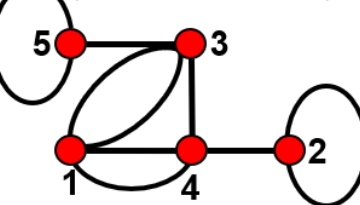
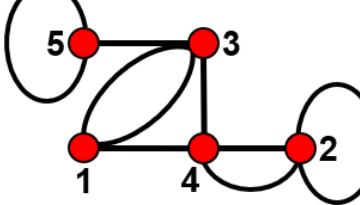
	<p>(8x1, 1x2, 4x2²) f</p> 	<p>(8x1, 1x2, 4x2²) g</p> 	<p>(8x1, 1x2, 4x2²) h</p> 	<p>(6x1, 4x2, 2x2¹) a</p> 
	<p>(6x1, 4x2, 2x2¹) b</p> 	<p>(6x1, 4x2, 2x2²) a</p> 	<p>(6x1, 4x2, 2x2²) b</p> 	<p>(6x1, 2x2, 4x2¹) a</p> 
	<p>(6x1, 2x2, 4x2¹) b</p> 	<p>(6x1, 2x2, 4x2¹) c</p> 	<p>(6x1, 2x2, 4x2¹) d</p> 	<p>(6x1, 2x2, 4x2¹) e</p> 
	<p>(6x1, 2x2, 4x2¹) f</p> 	<p>(6x1, 2x2, 4x2¹) g</p> 	<p>(6x1, 2x2, 2x2¹, 2x2²) a</p> 	<p>(6x1, 2x2, 2x2¹, 2x2²) b</p> 

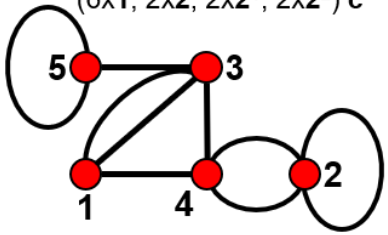
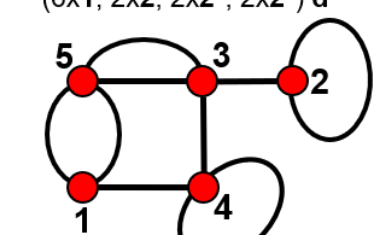
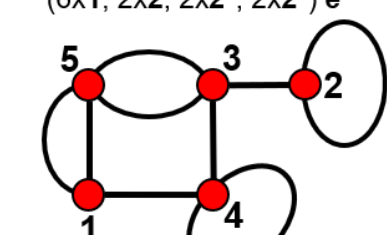
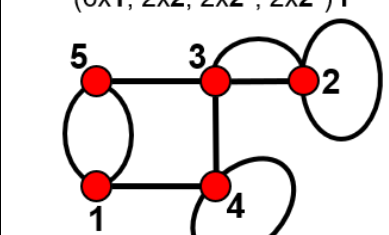
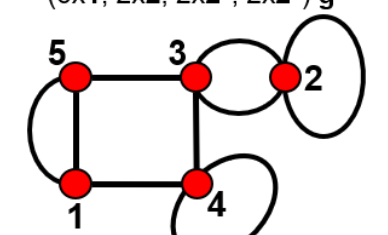
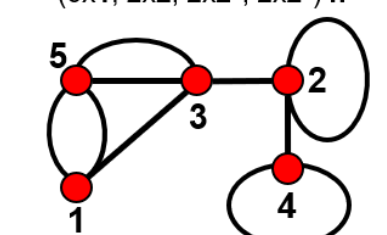
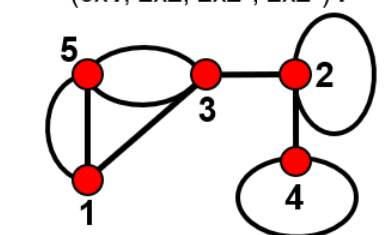
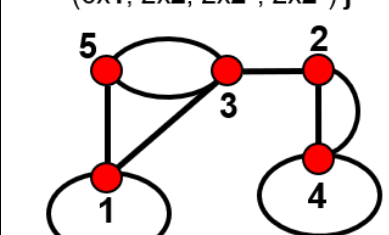
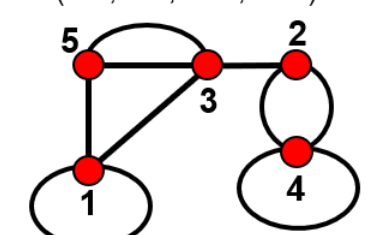
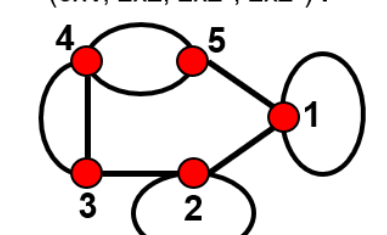
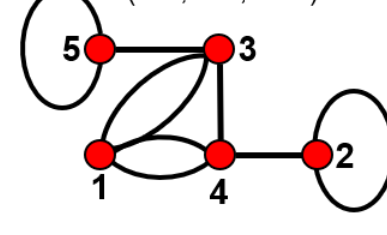
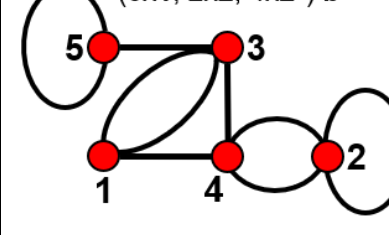
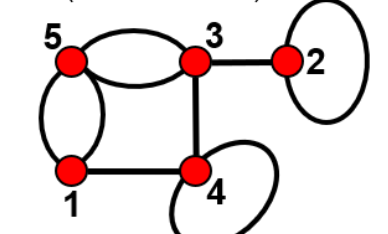
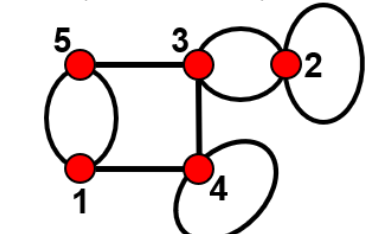
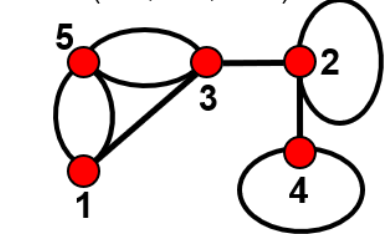
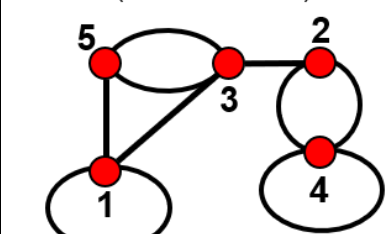
	<p>($6x1, 2x2, 2x2^1, 2x2^2$) c</p> 	<p>($6x1, 2x2, 2x2^1, 2x2^2$) d</p> 	<p>($6x1, 2x2, 2x2^1, 2x2^2$) e</p> 	<p>($6x1, 2x2, 2x2^1, 2x2^2$) f</p> 
	<p>($6x1, 2x2, 2x2^1, 2x2^2$) g</p> 	<p>($6x1, 2x2, 2x2^1, 2x2^2$) h</p> 	<p>($6x1, 2x2, 2x2^1, 2x2^2$) i</p> 	<p>($6x1, 2x2, 2x2^1, 2x2^2$) j</p> 
	<p>($6x1, 2x2, 2x2^1, 2x2^2$) k</p> 	<p>($6x1, 2x2, 2x2^1, 2x2^2$) l</p> 	<p>($6x1, 2x2, 4x2^2$) a</p> 	<p>($6x1, 2x2, 4x2^2$) b</p> 
	<p>($6x1, 2x2, 4x2^2$) c</p> 	<p>($6x1, 2x2, 4x2^2$) d</p> 	<p>($6x1, 2x2, 4x2^2$) e</p> 	<p>($6x1, 2x2, 4x2^2$) f</p> 

	<p>$(6x1, 2x2, 4x2^2)$ g</p>	<p>$(6x1, 6x2^1)$ a</p>	<p>$(6x1, 6x2^1)$ b</p>	<p>$(6x1, 4x2^1, 2x2^2)$ a</p>
	<p>$(6x1, 4x2^1, 2x2^2)$ b</p>	<p>$(6x1, 4x2^1, 2x2^2)$ c</p>	<p>$(6x1, 4x2^1, 2x2^2)$ d</p>	<p>$(6x1, 4x2^1, 2x2^2)$ e</p>
	<p>$(6x1, 2x2^1, 4x2^2)$ a</p>	<p>$(6x1, 2x2^1, 4x2^2)$ b</p>	<p>$(6x1, 2x2^1, 4x2^2)$ c</p>	<p>$(6x1, 2x2^1, 4x2^2)$ d</p>
	<p>$(6x1, 2x2^1, 4x2^2)$ e</p>	<p>$(6x1, 6x2^2)$ a</p>	<p>$(6x1, 6x2^2)$ b</p>	<p>$(4x1, 5x2, 2x2^1)$</p>

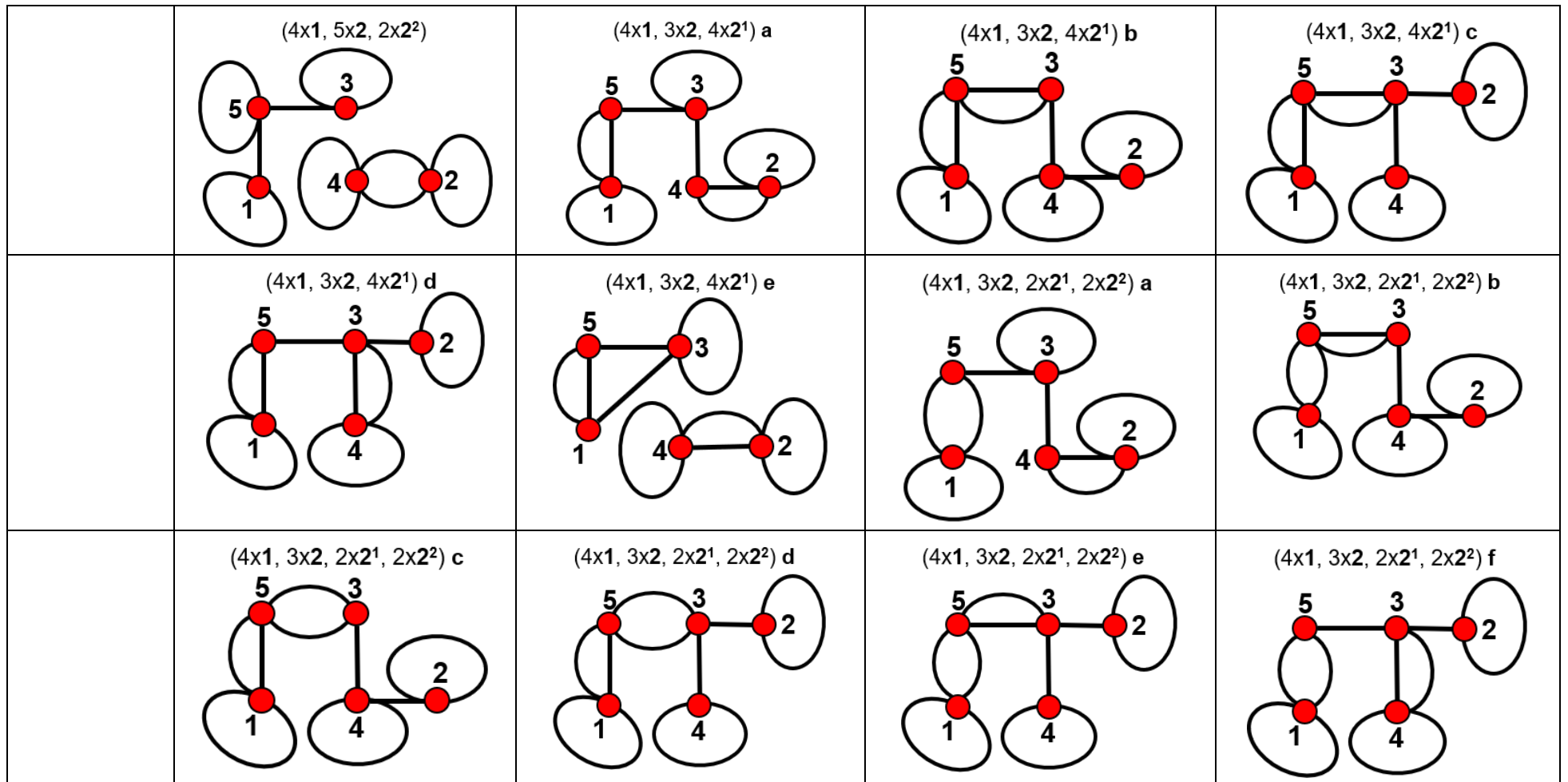

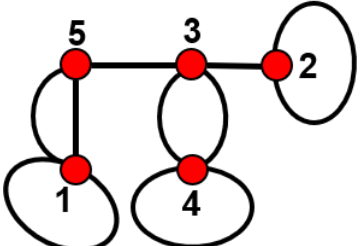
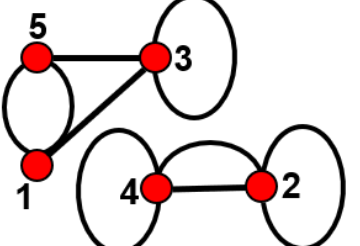
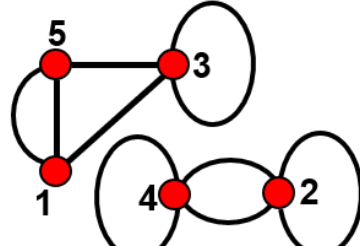
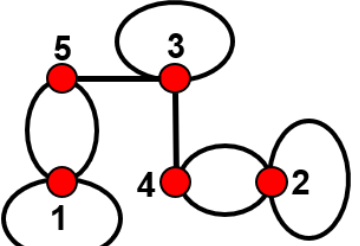
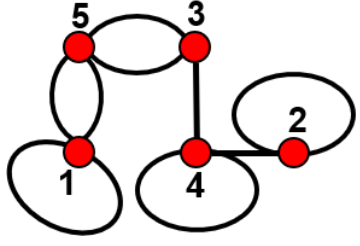
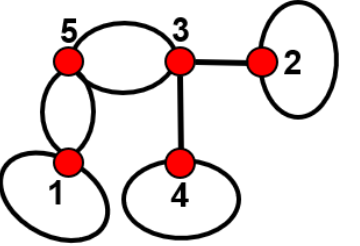
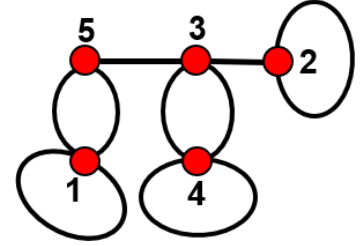
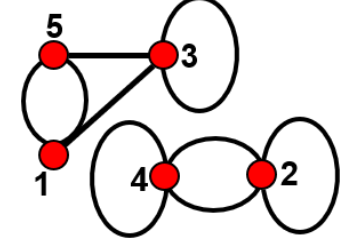
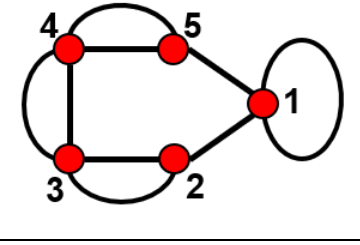
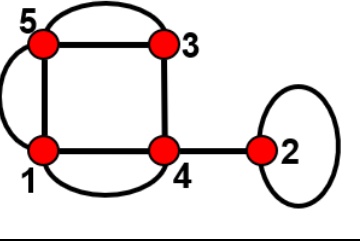
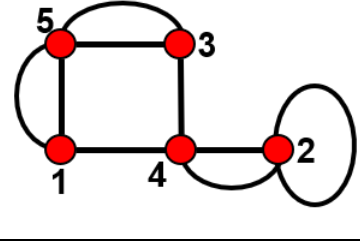
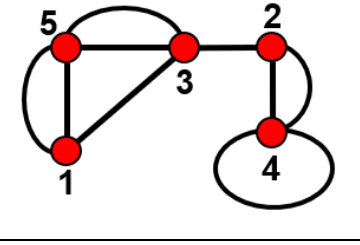
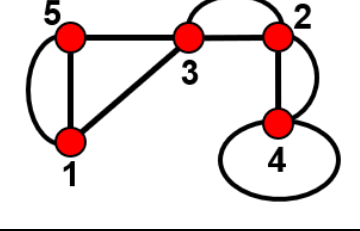
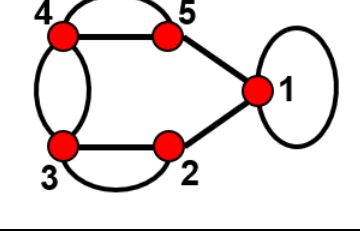
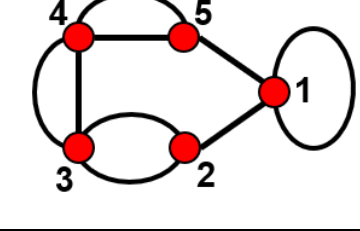
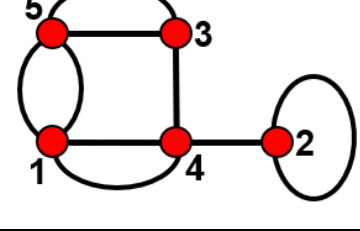
	<p>(4x1, 3x2, 2x2¹, 2x2²) g</p> 	<p>(4x1, 3x2, 2x2¹, 2x2²) h</p> 	<p>(4x1, 3x2, 2x2¹, 2x2²) i</p> 	<p>(4x1, 3x2, 4x2²) a</p> 
	<p>(4x1, 3x2, 4x2²) b</p> 	<p>(4x1, 3x2, 4x2²) c</p> 	<p>(4x1, 3x2, 4x2²) d</p> 	<p>(4x1, 3x2, 4x2²) e</p> 
	<p>(4x1, 1x2, 6x2¹) a</p> 	<p>(4x1, 1x2, 6x2¹) b</p> 	<p>(4x1, 1x2, 6x2¹) c</p> 	<p>(4x1, 1x2, 6x2¹) d</p> 
	<p>(4x1, 1x2, 6x2¹) e</p> 	<p>(4x1, 1x2, 4x2¹, 2x2²) a</p> 	<p>(4x1, 1x2, 4x2¹, 2x2²) b</p> 	<p>(4x1, 1x2, 4x2¹, 2x2²) c</p> 

	(4x1, 1x2, 4x2 ¹ , 2x2 ²) d 	(4x1, 1x2, 4x2 ¹ , 2x2 ²) e 	(4x1, 1x2, 4x2 ¹ , 2x2 ²) f 	(4x1, 1x2, 4x2 ¹ , 2x2 ²) g
	(4x1, 1x2, 4x2 ¹ , 2x2 ²) h 	(4x1, 1x2, 4x2 ¹ , 2x2 ²) i 	(4x1, 1x2, 4x2 ¹ , 2x2 ²) j 	(4x1, 1x2, 4x2 ¹ , 2x2 ²) k
	(4x1, 1x2, 4x2 ¹ , 2x2 ²) l 	(4x1, 1x2, 4x2 ¹ , 2x2 ²) m 	(4x1, 1x2, 2x2 ¹ , 4x2 ²) a 	(4x1, 1x2, 2x2 ¹ , 4x2 ²) b
	(4x1, 1x2, 2x2 ¹ , 4x2 ²) c 	(4x1, 1x2, 2x2 ¹ , 4x2 ²) d 	(4x1, 1x2, 2x2 ¹ , 4x2 ²) e 	(4x1, 1x2, 2x2 ¹ , 4x2 ²) f

	<p>$(4x1, 1x2, 2x2^1, 4x2^2)$ g</p>	<p>$(4x1, 1x2, 2x2^1, 4x2^2)$ h</p>	<p>$(4x1, 1x2, 2x2^1, 4x2^2)$ i</p>	<p>$(4x1, 1x2, 2x2^1, 4x2^2)$ j</p>
	<p>$(4x1, 1x2, 2x2^1, 4x2^2)$ k</p>	<p>$(4x1, 1x2, 2x2^1, 4x2^2)$ l</p>	<p>$(4x1, 1x2, 2x2^1, 4x2^2)$ m</p>	<p>$(4x1, 1x2, 6x2^2)$ a</p>
	<p>$(4x1, 1x2, 6x2^2)$ b</p>	<p>$(4x1, 1x2, 6x2^2)$ c</p>	<p>$(4x1, 1x2, 6x2^2)$ d</p>	<p>$(4x1, 1x2, 6x2^2)$ e</p>
	<p>$(2x1, 4x2, 4x2^1)$ a</p>	<p>$(2x1, 4x2, 4x2^1)$ b</p>	<p>$(2x1, 4x2, 2x2^1, 2x2^2)$ a</p>	<p>$(2x1, 4x2, 2x2^1, 2x2^2)$ b</p>

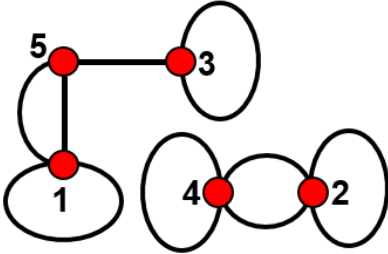
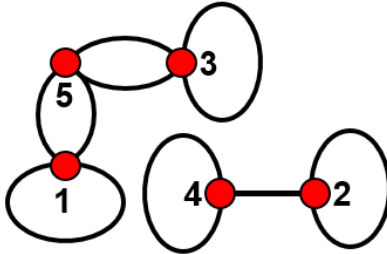
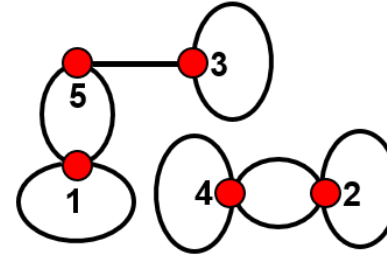
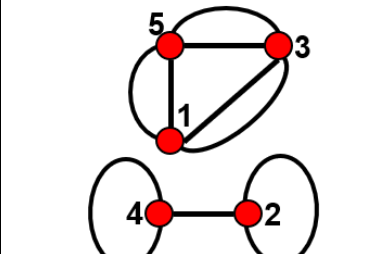
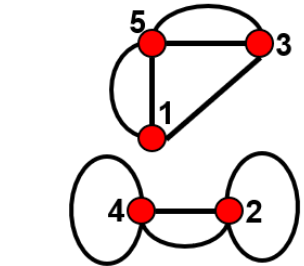
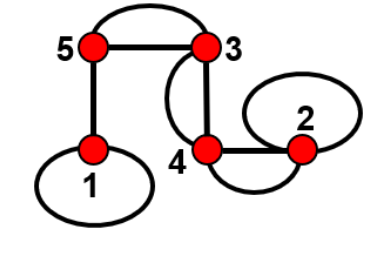
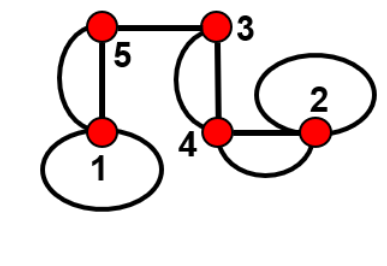
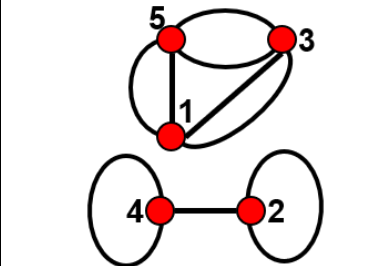
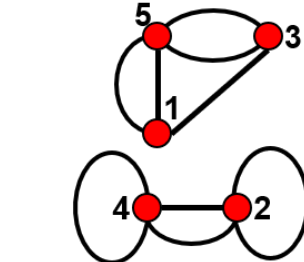
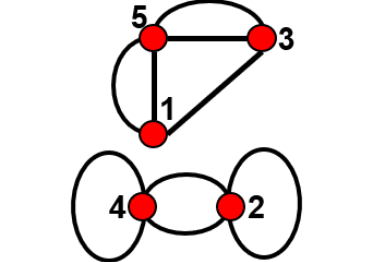
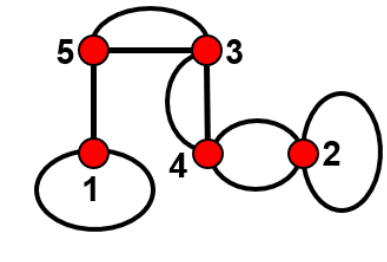
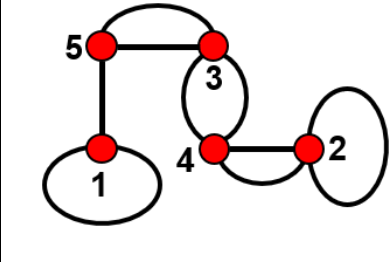
	<p>(2x1, 4x2, 2x2¹, 2x2²) c</p> 	<p>(2x1, 4x2, 4x2²) a</p> 	<p>(2x1, 4x2, 4x2²) b</p> 	<p>(2x1, 2x2, 6x2¹) a</p> 
	<p>(2x1, 2x2, 6x2¹) b</p> 	<p>(2x1, 2x2, 6x2¹) c</p> 	<p>(2x1, 2x2, 6x2¹) d</p> 	<p>(2x1, 2x2, 4x2¹, 2x2²) a</p> 
	<p>(2x1, 2x2, 4x2¹, 2x2²) b</p> 	<p>(2x1, 2x2, 4x2¹, 2x2²) c</p> 	<p>(2x1, 2x2, 4x2¹, 2x2²) d</p> 	<p>(2x1, 2x2, 4x2¹, 2x2²) e</p> 

	<p>$(2x1, 2x2, 4x2^1, 2x2^2)$ f</p>	<p>$(2x1, 2x2, 4x2^1, 2x2^2)$ g</p>	<p>$(2x1, 2x2, 4x2^1, 2x2^2)$ h</p>	<p>$(2x1, 2x2, 4x2^1, 2x2^2)$ i</p>
	<p>$(2x1, 2x2, 2x2^1, 4x2^2)$ a</p>	<p>$(2x1, 2x2, 2x2^1, 4x2^2)$ b</p>	<p>$(2x1, 2x2, 2x2^1, 4x2^2)$ c</p>	<p>$(2x1, 2x2, 2x2^1, 4x2^2)$ d</p>
	<p>$(2x1, 2x2, 2x2^1, 4x2^2)$ e</p>	<p>$(2x1, 2x2, 2x2^1, 4x2^2)$ f</p>	<p>$(2x1, 2x2, 2x2^1, 4x2^2)$ g</p>	<p>$(2x1, 2x2, 2x2^1, 4x2^2)$ h</p>

	<p>$(2x1, 2x2, 2x2^1, 4x2^2)$ i</p>	<p>$(2x1, 2x2, 6x2^2)$ a</p>	<p>$(2x1, 2x2, 6x2^2)$ b</p>	<p>$(2x1, 2x2, 6x2^2)$ c</p>
	<p>$(2x1, 2x2, 6x2^2)$ d</p>	<p>$(2x1, 8x2^1)$</p>	<p>$(2x1, 6x2^1, 2x2^2)$ a</p>	<p>$(2x1, 6x2^1, 2x2^2)$ b</p>
	<p>$(2x1, 4x2^1, 4x2^2)$ a</p>	<p>$(2x1, 4x2^1, 4x2^2)$ b</p>	<p>$(2x1, 4x2^1, 4x2^2)$ c</p>	<p>$(2x1, 2x2^1, 6x2^2)$ a</p>
	<p>$(2x1, 2x2^1, 6x2^2)$ b</p>	<p>$(2x1, 8x2^2)$</p>		

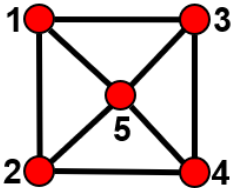
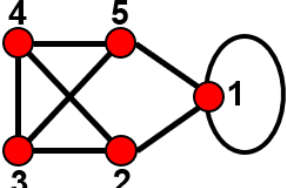
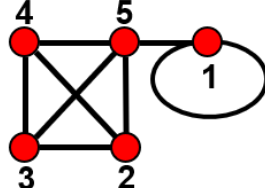
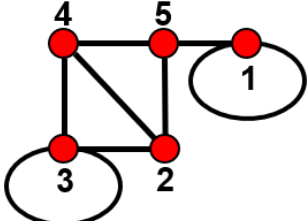
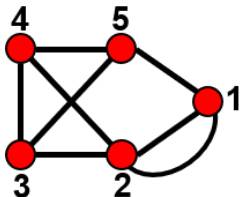
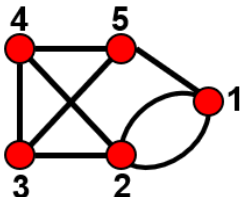
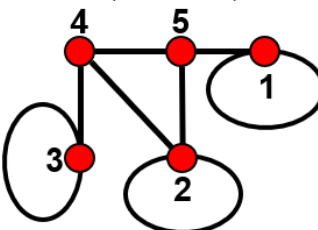
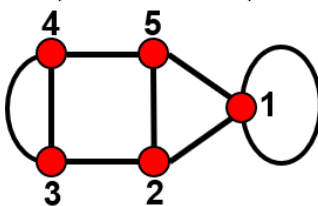
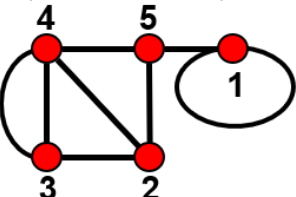
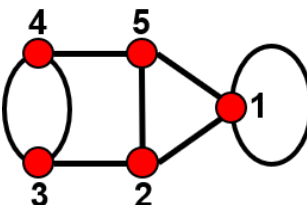
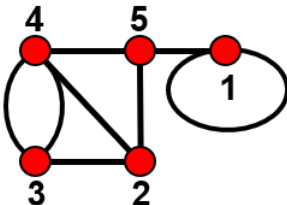
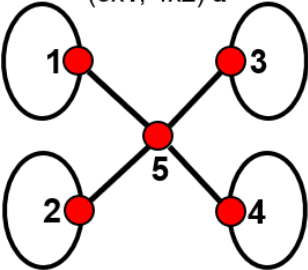
${}^3V_2^4V_4$	NG			
${}^3V_2^4V_5$	NG			
${}^3V_2^4V_6$	NG			
${}^3V_4^4V_1$	<p>(16x1)</p> 	<p>(14x1, 1x2) a</p> 	<p>(14x1, 1x2) b</p> 	<p>(12x1, 2x2)</p> 
	<p>(12x1, 2x2¹)</p> 	<p>(12x1, 2x2²)</p> 	<p>(10x1, 3x2)</p> 	<p>(10x1, 1x2, 2x2¹) a</p> 
	<p>(10x1, 1x2, 2x2¹) b</p> 	<p>(10x1, 1x2, 2x2²) a</p> 	<p>(10x1, 1x2, 2x2²) b</p> 	<p>(8x1, 4x2) a</p> 

	<p>(8x1, 4x2) b</p>	<p>(8x1, 2x2, 2x2¹) a</p>	<p>(8x1, 2x2, 2x2¹) b</p>	<p>(8x1, 2x2, 2x2¹) c</p>
	<p>(8x1, 2x2, 2x2²) d</p>	<p>(8x1, 2x2, 2x2²) a</p>	<p>(8x1, 2x2, 2x2²) b</p>	<p>(8x1, 2x2, 2x2²) c</p>
	<p>(8x1, 2x2, 2x2²) d</p>	<p>(8x1, 4x2¹) a</p>	<p>(8x1, 4x2¹) b</p>	<p>(8x1, 2x2¹, 2x2²) a</p>
	<p>(8x1, 2x2¹, 2x2²) b</p>	<p>(8x1, 2x2¹, 2x2²) c</p>	<p>(8x1, 4x2²) a</p>	<p>(8x1, 4x2²) b</p>

	<p>(6x1, 5x2)</p>	<p>(6x1, 3x2, 2x2¹) a</p>	<p>(6x1, 3x2, 2x2¹) b</p>	<p>(6x1, 3x2, 2x2¹) c</p>
	<p>(6x1, 3x2, 2x2²) d</p>	<p>(6x1, 3x2, 2x2²) a</p>	<p>(6x1, 3x2, 2x2²) b</p>	<p>(6x1, 3x2, 2x2²) c</p>
	<p>(6x1, 3x2, 2x2²) d</p>	<p>(6x1, 1x2, 4x2¹) a</p>	<p>(6x1, 1x2, 4x2¹) b</p>	<p>(6x1, 1x2, 4x2¹) c</p>

	<p>(6x1, 1x2, 4x2¹) d</p>	<p>(6x1, 1x2, 4x2¹) e</p>	<p>(6x1, 1x2, 2x2¹, 2x2²) a</p>	<p>(6x1, 1x2, 2x2¹, 2x2²) b</p>
	<p>(6x1, 1x2, 2x2¹, 2x2²) c</p>	<p>(6x1, 1x2, 2x2¹, 2x2²) d</p>	<p>(6x1, 1x2, 2x2¹, 2x2²) e</p>	<p>(6x1, 1x2, 2x2¹, 2x2²) f</p>
	<p>(6x1, 1x2, 2x2¹, 2x2²) g</p>	<p>(6x1, 1x2, 2x2¹, 2x2²) h</p>	<p>(6x1, 1x2, 4x2²) a</p>	<p>(6x1, 1x2, 4x2²) b</p>
	<p>(6x1, 1x2, 4x2²) c</p>	<p>(6x1, 1x2, 4x2²) d</p>	<p>(6x1, 1x2, 4x2²) e</p>	<p>(4x1, 4x2, 2x2¹)</p>

	<p>$(4x1, 4x2, 2x2^2)$</p>	<p>$(4x1, 2x2, 4x2^1) a$</p>	<p>$(4x1, 2x2, 4x2^1) b$</p>	<p>$(4x1, 2x2, 4x2^1) c$</p>
	<p>$(4x1, 2x2, 2x2^1, 2x2^2) a$</p>	<p>$(4x1, 2x2, 2x2^1, 2x2^2) b$</p>	<p>$(4x1, 2x2, 2x2^1, 2x2^2) c$</p>	<p>$(4x1, 2x2, 2x2^1, 2x2^2) d$</p>
	<p>$(4x1, 2x2, 4x2^2) a$</p>	<p>$(4x1, 2x2, 4x2^2) b$</p>	<p>$(4x1, 2x2, 4x2^2) c$</p>	<p>$(4x1, 6x2^1)$</p>

	(4x1, 4x2 ¹ , 2x2 ²) a 	(4x1, 4x2 ¹ , 2x2 ²) b 	(4x1, 2x2 ¹ , 4x2 ²) a 	(4x1, 2x2 ¹ , 4x2 ²) b
	(4x1, 6x2 ²) 			
${}^3V_4^4V_2$	NG			
${}^3V_4^4V_3$	NG			
${}^3V_4^4V_4$	NG			
${}^3V_6^4V_1$	NG			
${}^3V_6^4V_2$	NG			
Rank 3				
${}^1V_r^2V_r^3V_r$				
${}^1V_1^2V_1^3V_1$	(4x1, 1x2) 	(2x1, 2x2) 	(2x1, 2x2 ¹) 	(2x1, 2x2 ²)

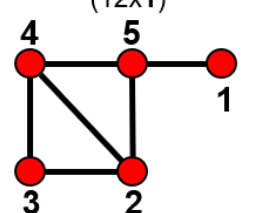
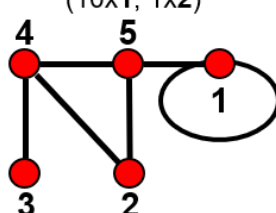
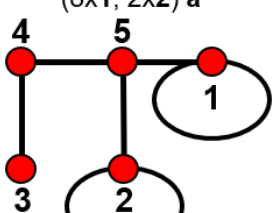
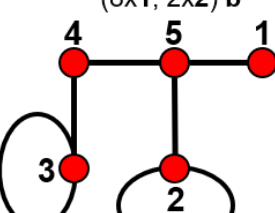
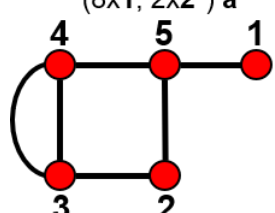
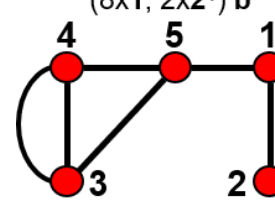
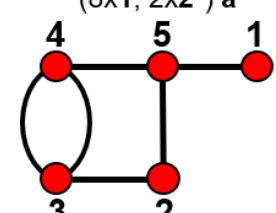
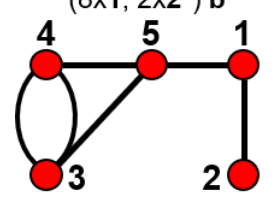
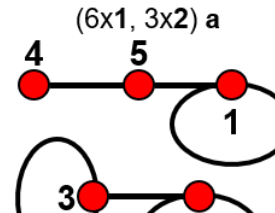
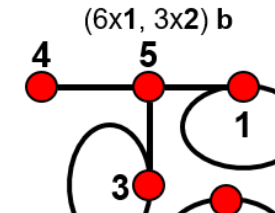
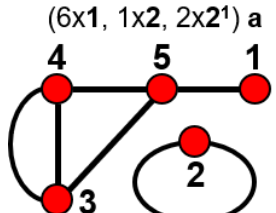
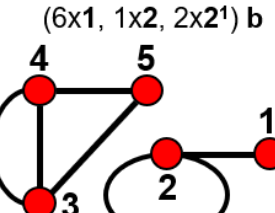
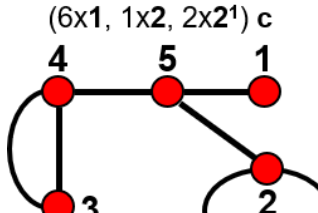
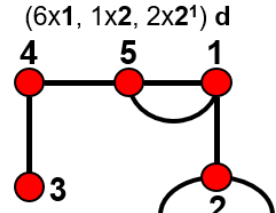
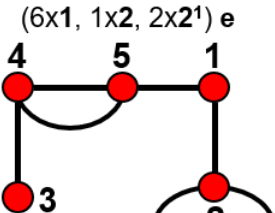
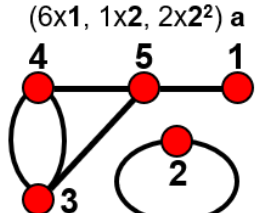
${}^1V_1^2V_1^3V_3$	<p>(12x1)</p> 	<p>(10x1, 1x2)</p> 	<p>(8x1, 2x2) a</p> 	<p>(8x1, 2x2) b</p> 
	<p>(8x1, 2x2¹) a</p> 	<p>(8x1, 2x2¹) b</p> 	<p>(8x1, 2x2²) a</p> 	<p>(8x1, 2x2²) b</p> 
	<p>(6x1, 3x2) a</p> 	<p>(6x1, 3x2) b</p> 	<p>(6x1, 1x2, 2x2¹) a</p> 	<p>(6x1, 1x2, 2x2¹) b</p> 
	<p>(6x1, 1x2, 2x2¹) c</p> 	<p>(6x1, 1x2, 2x2¹) d</p> 	<p>(6x1, 1x2, 2x2¹) e</p> 	<p>(6x1, 1x2, 2x2²) a</p> 

	<p>(6x1, 1x2, 2x2²) b</p>	<p>(6x1, 1x2, 2x2²) c</p>	<p>(6x1, 1x2, 2x2²) d</p>	<p>(6x1, 1x2, 2x2²) e</p>
	<p>(4x1, 4x2)</p>	<p>(4x1, 2x2, 2x2¹) a</p>	<p>(4x1, 2x2, 2x2¹) b</p>	<p>(4x1, 2x2, 2x2¹) c</p>
	<p>(4x1, 2x2, 2x2²) a</p>	<p>(4x1, 2x2, 2x2²) b</p>	<p>(4x1, 2x2, 2x2²) c</p>	<p>(4x1, 4x2¹) c</p>
	<p>(4x1, 2x2¹, 2x2²) a</p>	<p>(4x1, 2x2¹, 2x2²) b</p>	<p>(4x1, 4x2²)</p>	

${}^1V_1^2V_1^3V_5$	NG			
${}^1V_1^2V_2^3V_1$	<p>(8x1)</p>	<p>(6x1, 1x2)</p>	<p>(4x1, 2x2)</p>	<p>(4x1, 2x2¹)</p>
	<p>(4x1, 2x2²)</p>	<p>(2x1, 3x2)</p>	<p>(2x1, 1x2, 2x2¹) a</p>	<p>(2x1, 1x2, 2x2¹) b</p>
	<p>(2x1, 1x2, 2x2²) a</p>	<p>(2x1, 1x2, 2x2²) b</p>		
${}^1V_1^2V_2^3V_3$	<p>(14x1) a</p>	<p>(14x1) b</p>	<p>(14x1) c</p>	<p>(14x1) d</p>

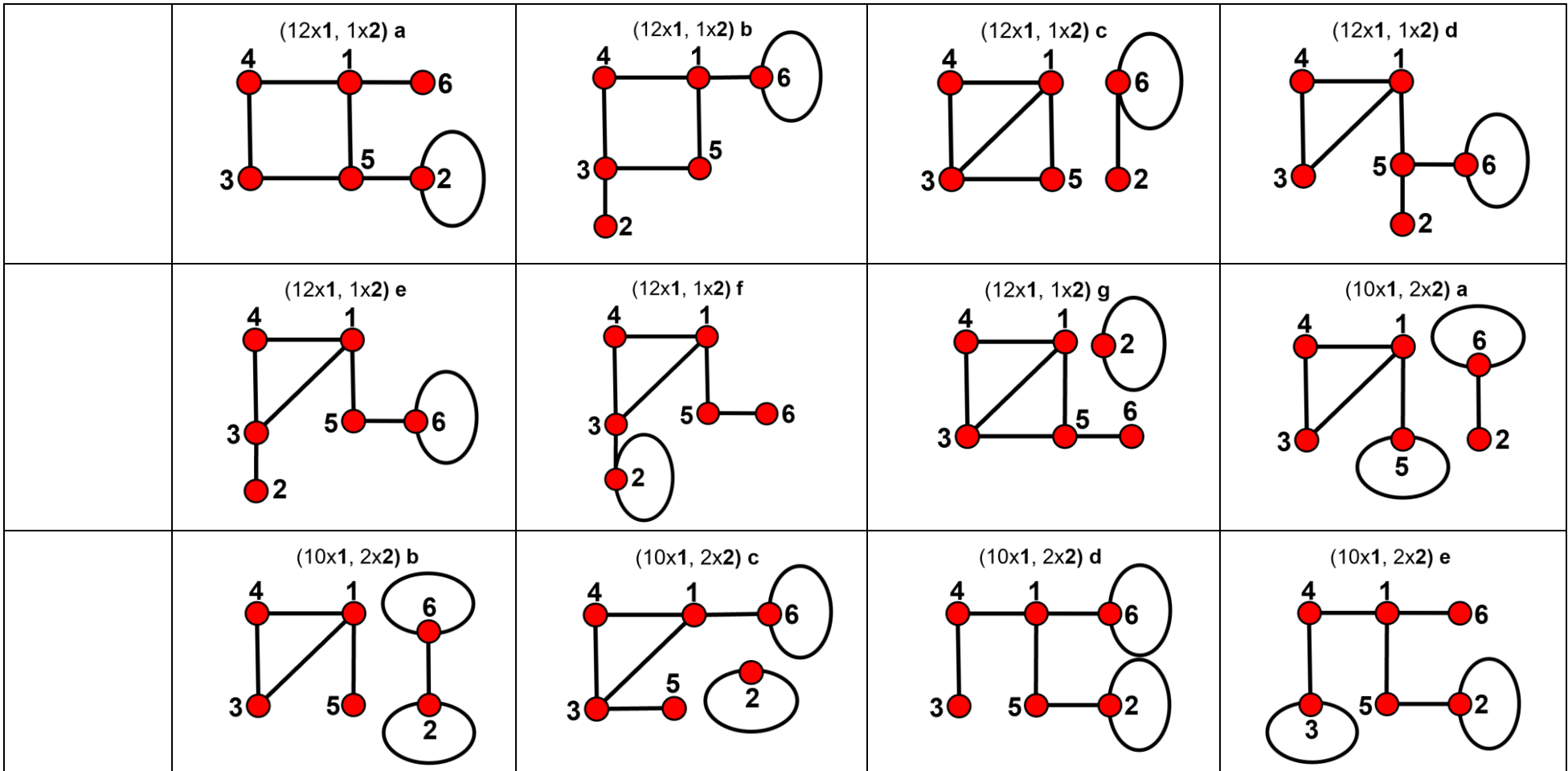

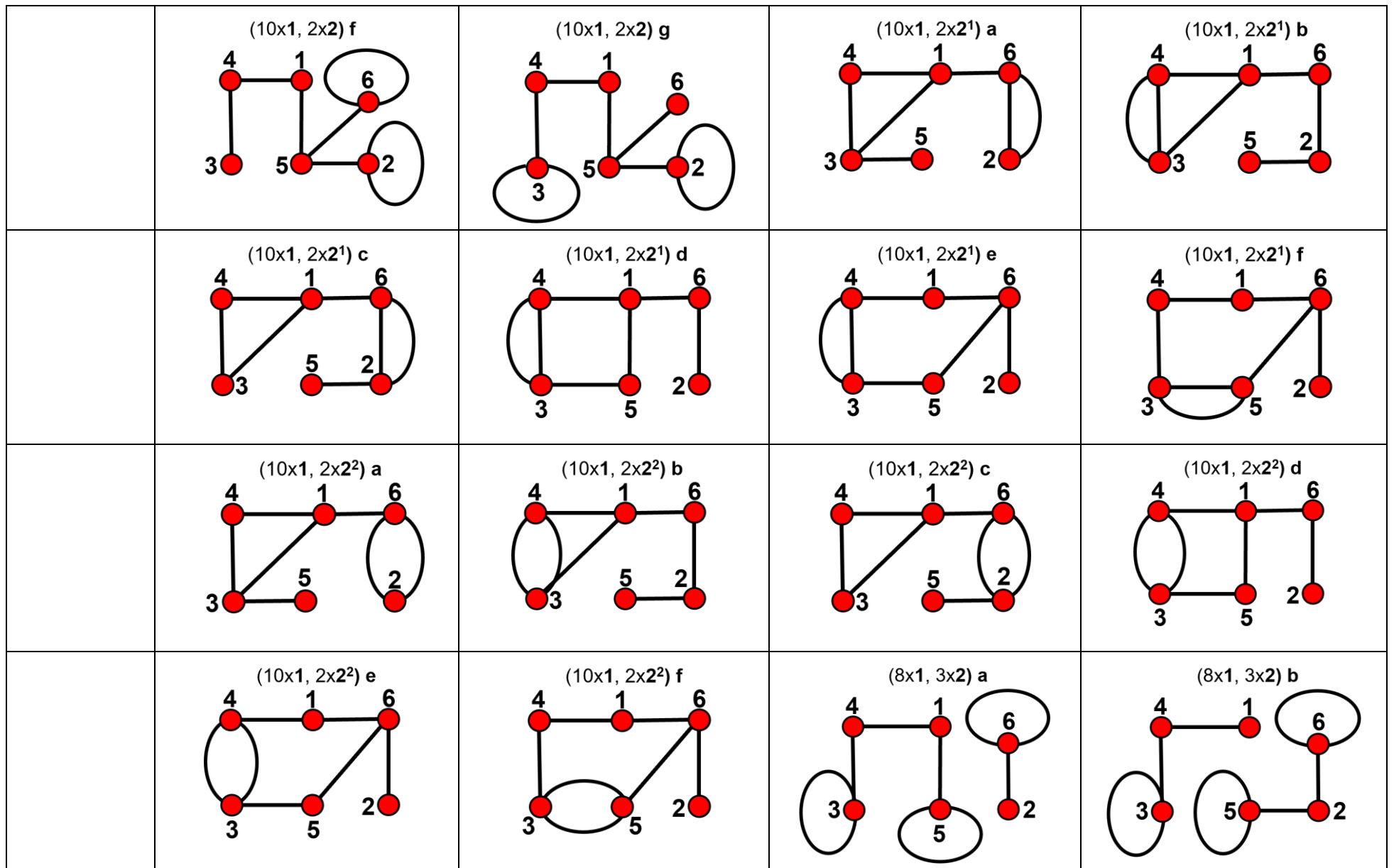

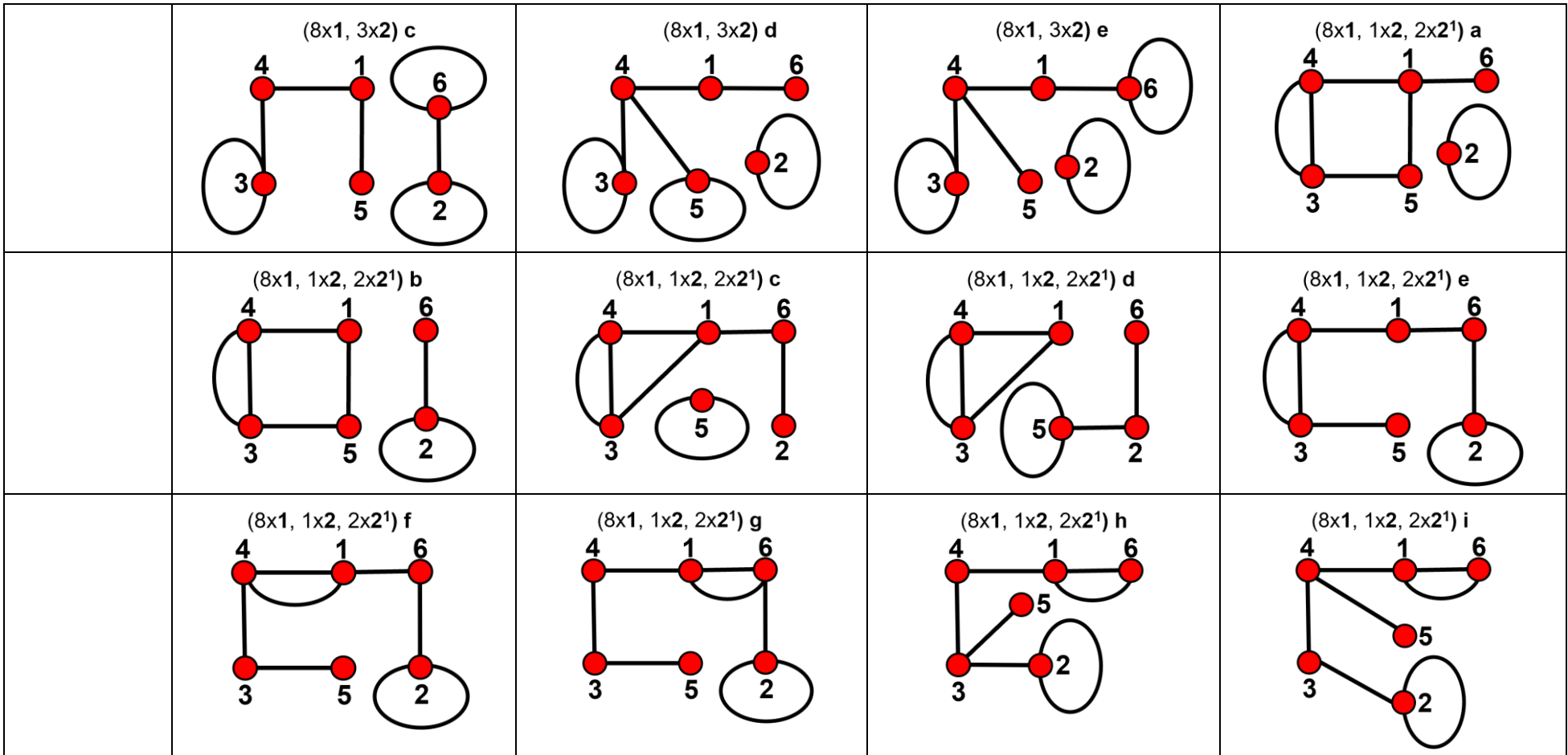

	<p>(8x1, 1x2, 2x2¹) j</p>	<p>(8x1, 1x2, 2x2²) a</p>	<p>(8x1, 1x2, 2x2²) b</p>	<p>(8x1, 1x2, 2x2²) c</p>
	<p>(8x1, 1x2, 2x2²) d</p>	<p>(8x1, 1x2, 2x2²) e</p>	<p>(8x1, 1x2, 2x2²) f</p>	<p>(8x1, 1x2, 2x2²) g</p>
	<p>(8x1, 1x2, 2x2²) h</p>	<p>(8x1, 1x2, 2x2²) i</p>	<p>(8x1, 1x2, 2x2²) j</p>	<p>(6x1, 4x2) a</p>

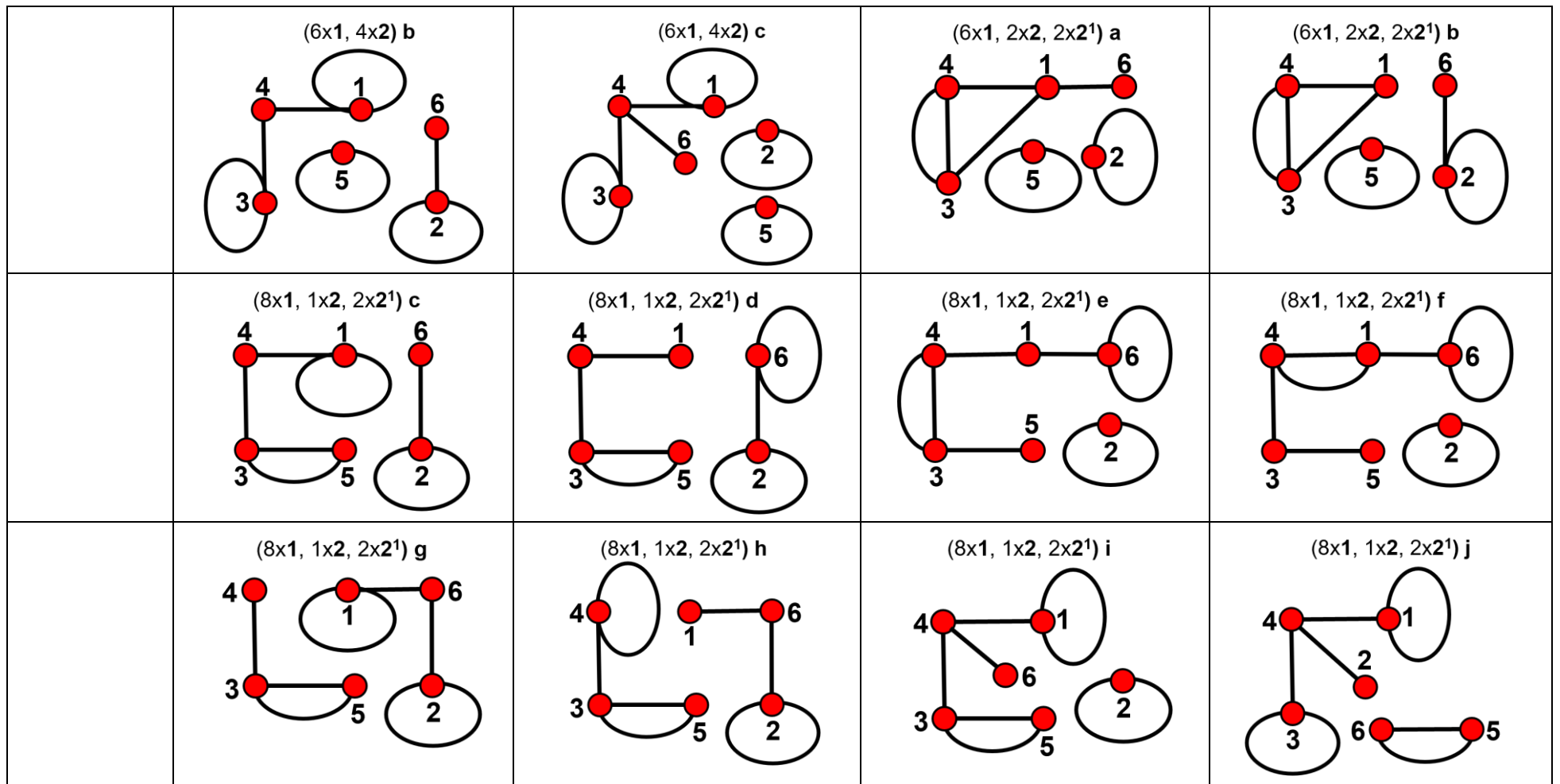

	<p>(6x1, 2x2, 2x2²) a</p>	<p>(6x1, 2x2, 2x2²) b</p>	<p>(8x1, 1x2, 2x2²) c</p>	<p>(8x1, 1x2, 2x2²) d</p>
	<p>(8x1, 1x2, 2x2²) e</p>	<p>(8x1, 1x2, 2x2²) f</p>	<p>(8x1, 1x2, 2x2²) g</p>	<p>(8x1, 1x2, 2x2²) h</p>
	<p>(8x1, 1x2, 2x2²) i</p>	<p>(8x1, 1x2, 2x2²) j</p>	<p>(6x1, 4x2¹) a</p>	<p>(6x1, 4x2¹) b</p>

	<p>(6x1, 4x2¹) c</p>	<p>(6x1, 4x2¹) d</p>	<p>(6x1, 4x2¹) e</p>	<p>(6x1, 2x2¹, 2x2²) a</p>
	<p>(6x1, 2x2¹, 2x2²) b</p>	<p>(6x1, 2x2¹, 2x2²) c</p>	<p>(6x1, 2x2¹, 2x2²) d</p>	<p>(6x1, 2x2¹, 2x2²) e</p>
	<p>(6x1, 2x2¹, 2x2²) f</p>	<p>(6x1, 2x2¹, 2x2²) g</p>	<p>(6x1, 2x2¹, 2x2²) h</p>	<p>(6x1, 2x2¹, 2x2²) i</p>

	<p>(6x1, 4x2²) a</p>	<p>(6x1, 4x2²) b</p>	<p>(6x1, 4x2²) c</p>	<p>(6x1, 4x2²) d</p>
	<p>(6x1, 4x2²) e</p>	<p>(4x1, 5x2)</p>	<p>(4x1, 3x2, 2x2¹) a</p>	<p>(4x1, 3x2, 2x2¹) b</p>
	<p>(4x1, 3x2, 2x2¹) c</p>	<p>(4x1, 3x2, 2x2¹) d</p>	<p>(4x1, 3x2, 2x2²) a</p>	<p>(4x1, 3x2, 2x2²) b</p>

	<p>(4x1, 3x2, 2x2²) c</p>	<p>(4x1, 3x2, 2x2²) d</p>	<p>(4x1, 1x2, 4x2¹) a</p>	<p>(4x1, 1x2, 4x2¹) b</p>
	<p>(4x1, 1x2, 4x2¹) c</p>	<p>(4x1, 1x2, 4x2¹) d</p>	<p>(4x1, 1x2, 2x2¹, 2x2²) a</p>	<p>(4x1, 1x2, 2x2¹, 2x2²) b</p>
	<p>(4x1, 1x2, 2x2¹, 2x2²) c</p>	<p>(4x1, 1x2, 2x2¹, 2x2²) d</p>	<p>(4x1, 1x2, 2x2¹, 2x2²) e</p>	<p>(4x1, 1x2, 2x2¹, 2x2²) f</p>

	(4x1, 1x2, 2x2 ¹ , 2x2 ²) g 	(4x1, 1x2, 4x2 ²) a 	(4x1, 1x2, 4x2 ²) b 	(4x1, 1x2, 4x2 ²) c
	(4x1, 1x2, 4x2 ²) d 			
${}^1V_1^2V_2^3V_5$	NG			
${}^1V_1^2V_3^3V_1$	(10x1) a 	(10x1) b 	(8x1, 1x2) a 	(8x1, 1x2) b
	(8x1, 1x2) c 	(6x1, 2x2) 	(6x1, 2x2 ¹) 	(6x1, 2x2 ²)

	<p>(4x1, 3x2)</p>	<p>(4x1, 1x2, 2x2¹) a</p>	<p>(4x1, 1x2, 2x2¹) b</p>	<p>(4x1, 1x2, 2x2²) a</p>
	<p>(4x1, 1x2, 2x2²) b</p>	<p>(2x1, 4x2)</p>	<p>(2x1, 2x2, 2x2¹) a</p>	<p>(2x1, 2x2, 2x2¹) b</p>
	<p>(2x1, 2x2, 2x2²) a</p>	<p>(2x1, 2x2, 2x2²) b</p>	<p>(2x1, 4x2¹)</p>	<p>(2x1, 2x2¹, 2x2²) a</p>
	<p>(2x1, 2x2¹, 2x2²) b</p>	<p>(2x1, 4x2²)</p>		

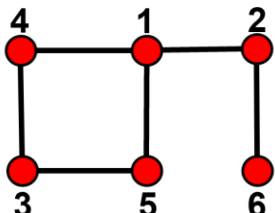
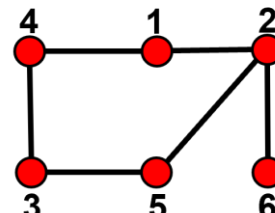
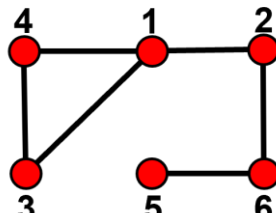
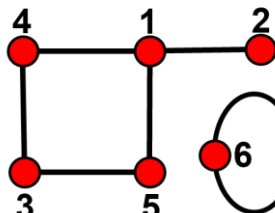
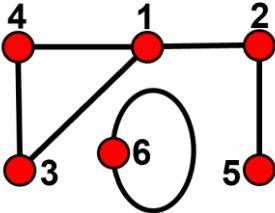
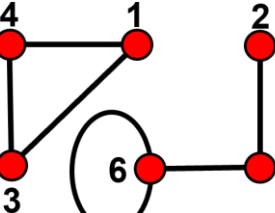
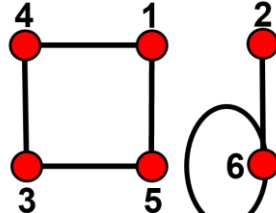
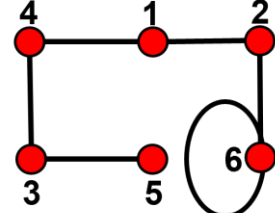
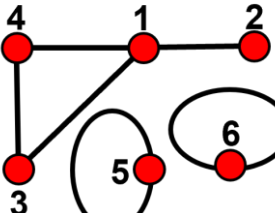
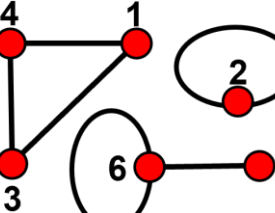
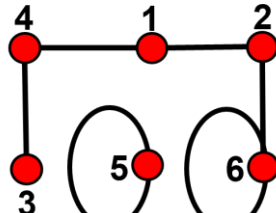
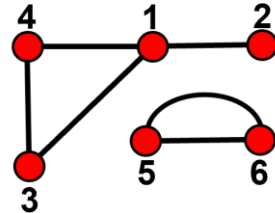
${}^1V_1^2V_3^3V_3$	NG			
${}^1V_1^2V_4^3V_1$	<p>(12x1) a</p> 	<p>(12x1) b</p> 	<p>(12x1) c</p> 	<p>(10x1, 1x2) a</p> 
	<p>(10x1, 1x2) b</p> 	<p>(10x1, 1x2) c</p> 	<p>(10x1, 1x2) d</p> 	<p>(10x1, 1x2) e</p> 
	<p>(8x1, 2x2) a</p> 	<p>(8x1, 2x2) b</p> 	<p>(8x1, 2x2) c</p> 	<p>(8x1, 2x2¹) a</p> 

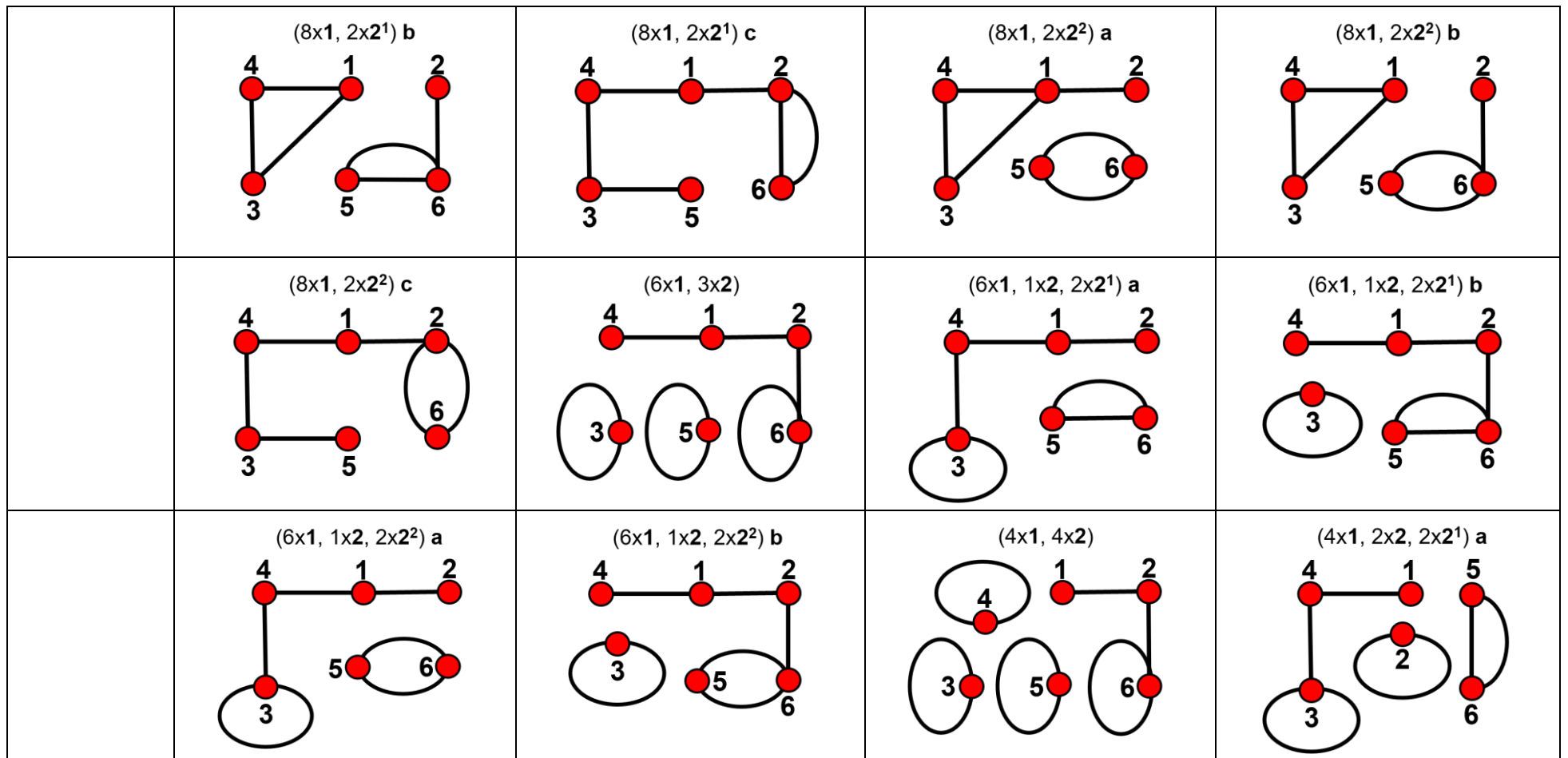

	<p>(4x1, 2x2, 2x2¹) b</p>	<p>(4x1, 2x2, 2x2²) a</p>	<p>(4x1, 2x2, 2x2²) b</p>	<p>(4x1, 4x2¹)</p>
	<p>(4x1, 2x2¹, 2x2²) a</p>	<p>(4x1, 2x2¹, 2x2²) b</p>	<p>(4x1, 4x2²)</p>	<p>(2x1, 5x2)</p>
	<p>(2x1, 3x2, 2x2¹) a</p>	<p>(2x1, 3x2, 2x2¹) b</p>	<p>(2x1, 3x2, 2x2²) a</p>	<p>(2x1, 3x2, 2x2²) b</p>

	<p>(2x1, 1x2, 4x2¹) a</p>	<p>(2x1, 1x2, 4x2¹) b</p>	<p>(2x1, 1x2, 2x2¹, 2x2²) a</p>	<p>(2x1, 1x2, 2x2¹, 2x2²) b</p>
	<p>(2x1, 1x2, 2x2¹, 2x2²) c</p>	<p>(2x1, 1x2, 4x2²) a</p>	<p>(2x1, 1x2, 4x2²) b</p>	
${}^1V_1^2V_4^3V_3$	NG			
${}^1V_1^2V_5^3V_1$	NG			
${}^1V_1^2V_6^3V_1$	NG			
${}^1V_2^2V_1^3V_2$	<p>(10x1)</p>	<p>(8x1, 1x2) a</p>	<p>(8x1, 1x2) b</p>	<p>(6x1, 2x2) a</p>

	<p>(6x1, 2x2) b</p>	<p>(6x1, 2x2) c</p>	<p>(6x1, 2x2) d</p>	<p>(6x1, 2x2^1) a</p>
	<p>(6x1, 2x2^1) b</p>	<p>(6x1, 2x2^1) c</p>	<p>(6x1, 2x2^2) a</p>	<p>(6x1, 2x2^2) b</p>
	<p>(6x1, 2x2^2) c</p>	<p>(4x1, 3x2) a</p>	<p>(4x1, 3x2) b</p>	<p>(4x1, 1x2, 2x2^1) a</p>
	<p>(4x1, 1x2, 2x2^1) b</p>	<p>(4x1, 1x2, 2x2^1) c</p>	<p>(4x1, 1x2, 2x2^2) a</p>	<p>(4x1, 1x2, 2x2^2) b</p>

	<p>(4x1, 1x2, 2x2²) c</p>			
${}^1V_2^2V_1^3V_4$	NG			
${}^1V_2^2V_2^3V_2$	<p>(12x1) a</p>	<p>(12x1) b</p>	<p>(12x1) c</p>	<p>(12x1) d</p>
	<p>(12x1) e</p>	<p>(10x1, 1x2) a</p>	<p>(10x1, 1x2) b</p>	<p>(10x1, 1x2) c</p>

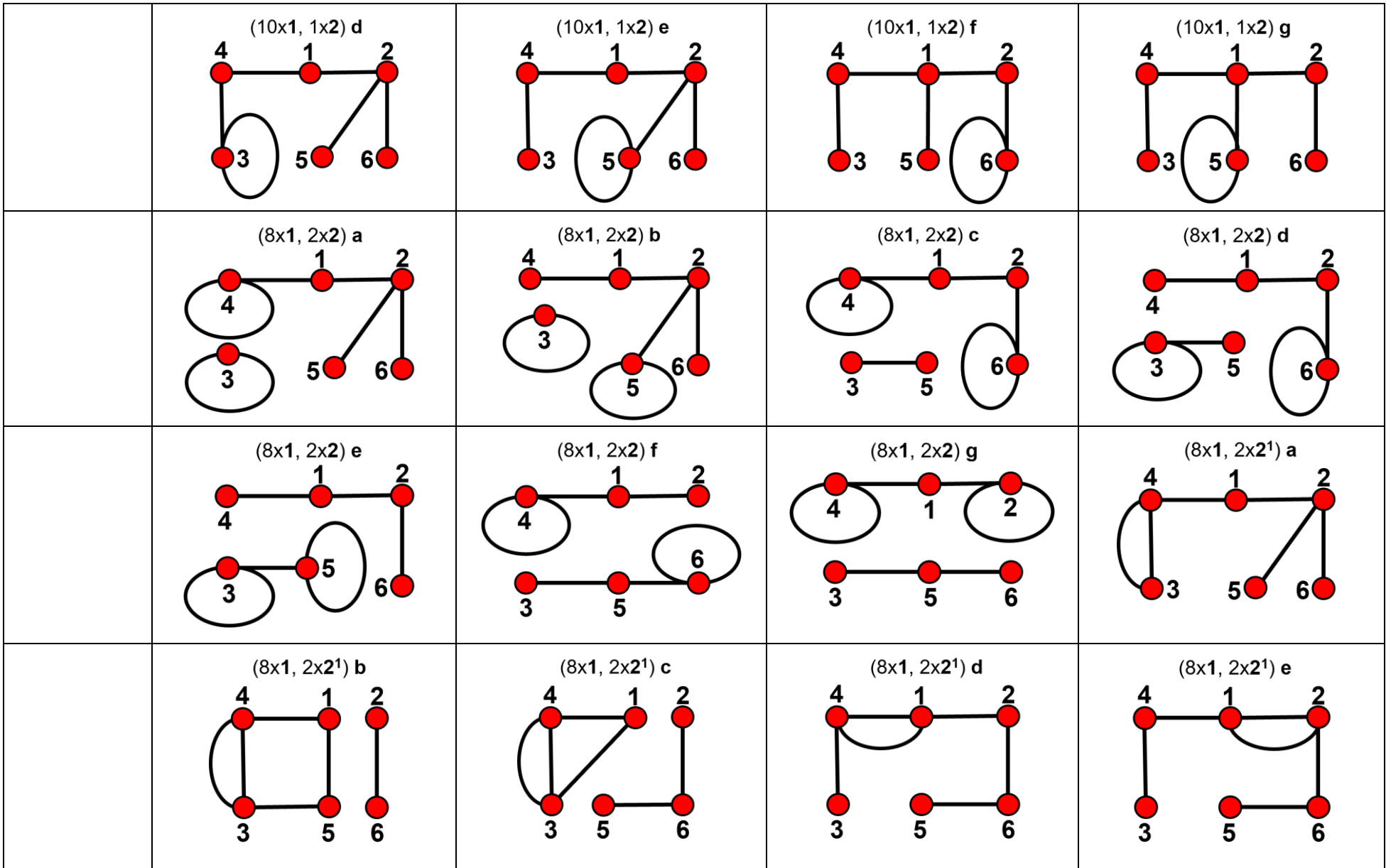

	<p>(8x1, 2x2¹) f</p>	<p>(8x1, 2x2²) a</p>	<p>(8x1, 2x2²) b</p>	<p>(8x1, 2x2²) c</p>
	<p>(8x1, 2x2²) d</p>	<p>(8x1, 2x2²) e</p>	<p>(8x1, 2x2²) f</p>	<p>(6x1, 3x2) a</p>
	<p>(6x1, 3x2) b</p>	<p>(6x1, 3x2) c</p>	<p>(6x1, 3x2) d</p>	<p>(6x1, 1x2, 2x2¹) a</p>

	<p>(6x1, 1x2, 2x2¹) b</p>	<p>(6x1, 1x2, 2x2¹) c</p>	<p>(6x1, 1x2, 2x2¹) d</p>	<p>(6x1, 1x2, 2x2¹) e</p>
	<p>(6x1, 1x2, 2x2¹) f</p>	<p>(6x1, 1x2, 2x2¹) g</p>	<p>(6x1, 1x2, 2x2¹) h</p>	<p>(6x1, 1x2, 2x2²) a</p>
	<p>(6x1, 1x2, 2x2²) b</p>	<p>(6x1, 1x2, 2x2²) c</p>	<p>(6x1, 1x2, 2x2²) d</p>	<p>(6x1, 1x2, 2x2²) e</p>

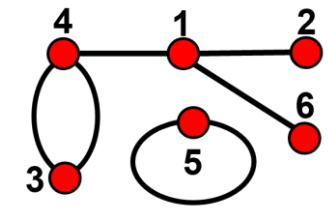
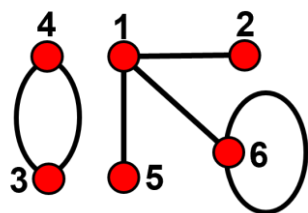
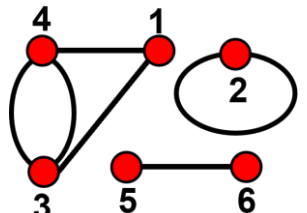
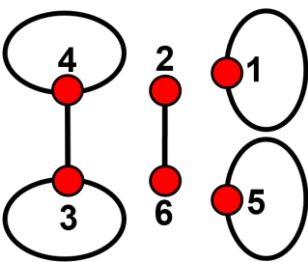
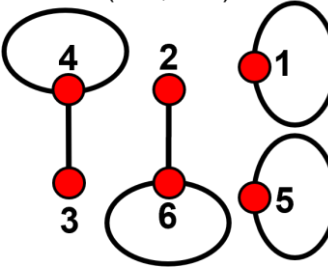
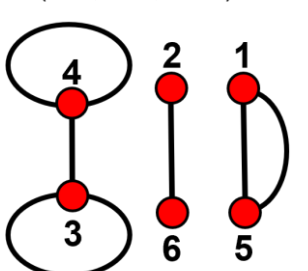
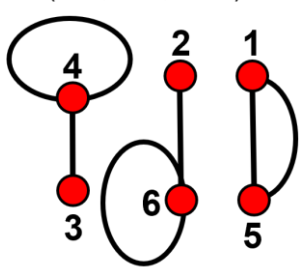
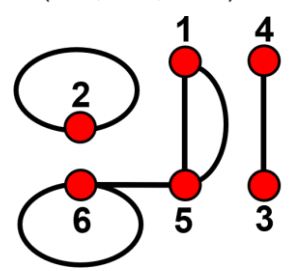
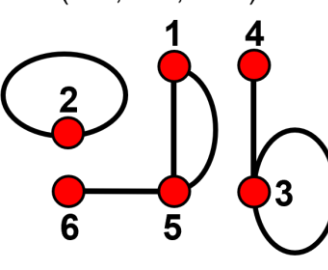
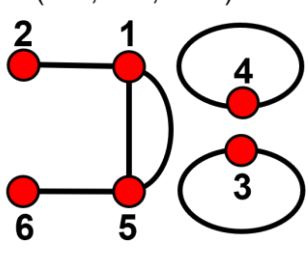
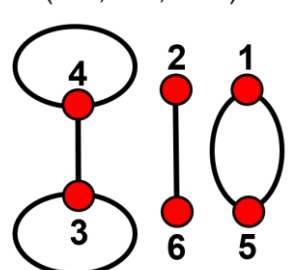
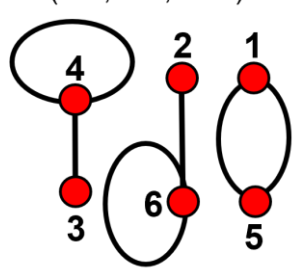
	<p>(6x1, 1x2, 2x2²) f</p> 	<p>(6x1, 1x2, 2x2²) g</p> 	<p>(6x1, 1x2, 2x2²) h</p> 	<p>(4x1, 4x2) a</p> 
	<p>(4x1, 4x2) b</p> 	<p>(4x1, 2x2, 2x2¹) a</p> 	<p>(4x1, 2x2, 2x2¹) b</p> 	<p>(4x1, 2x2, 2x2¹) c</p> 
	<p>(4x1, 2x2, 2x2¹) d</p> 	<p>(4x1, 2x2, 2x2¹) e</p> 	<p>(4x1, 2x2, 2x2²) a</p> 	<p>(4x1, 2x2, 2x2²) b</p> 

	<p>(4x1, 2x2, 2x2²) c</p>	<p>(4x1, 2x2, 2x2²) d</p>	<p>(4x1, 2x2, 2x2²) e</p>	<p>(4x1, 4x2¹) a</p>
	<p>(4x1, 4x2¹) b</p>	<p>(4x1, 4x2¹) c</p>	<p>(4x1, 2x2¹, 2x2²) a</p>	<p>(4x1, 2x2¹, 2x2²) b</p>
	<p>(4x1, 2x2¹, 2x2²) c</p>	<p>(4x1, 2x2¹, 2x2²) d</p>	<p>(4x1, 4x2²) a</p>	<p>(4x1, 4x2²) b</p>
	<p>(4x1, 4x2²) c</p>			

${}^1V_2^2V_2^3V_4$	NG				
${}^1V_2^2V_3^3V_2$	NG				
${}^1V_2^2V_4^3V_2$	NG				
${}^1V_3^2V_1^3V_1$	(8x1)	(6x1, 1x2) a	(6x1, 1x2) b	(6x1, 1x2) c	
	(4x1, 2x2)	(4x1, 2x2^1)	(4x1, 2x2^2)		
${}^1V_3^2V_1^3V_3$	NG				
${}^1V_3^2V_2^3V_1$	(10x1) a	(10x1) b	(10x1) c	(8x1, 1x2) a	

	<p>(8x1, 1x2) b</p>	<p>(8x1, 1x2) c</p>	<p>(8x1, 1x2) d</p>	<p>(6x1, 2x2) a</p>
	<p>(6x1, 2x2) b</p>	<p>(6x1, 2x2) c</p>	<p>(6x1, 2x2^1) a</p>	<p>(6x1, 2x2^1) b</p>
	<p>(6x1, 2x2^1) c</p>	<p>(6x1, 2x2^2) a</p>	<p>(6x1, 2x2^2) b</p>	<p>(6x1, 2x2^2) c</p>
	<p>(4x1, 3x2)</p>	<p>(4x1, 1x2, 2x2^1) a</p>	<p>(4x1, 1x2, 2x2^1) b</p>	<p>(4x1, 1x2, 2x2^2) a</p>

	<p>(4x1, 1x2, 2x2²) b</p>			
${}^1V_3^2V_2^3V_3$	NG			
${}^1V_3^2V_3^3V_1$	NG			
${}^1V_3^2V_4^3V_1$	NG			
${}^1V_4^2V_1^3V_2$	<p>(12x1) a</p>	<p>(12x1) b</p>	<p>(12x1) c</p>	<p>(10x1, 1x2) a</p>
	<p>(10x1, 1x2) b</p>	<p>(10x1, 1x2) c</p>	<p>(10x1, 1x2) d</p>	<p>(10x1, 1x2) e</p>

	<p>(10x1, 1x2) f</p>	<p>(8x1, 2x2) a</p>	<p>(8x1, 2x2) b</p>	<p>(8x1, 2x2) c</p>
	<p>(8x1, 2x2) d</p>	<p>(8x1, 2x2) e</p>	<p>(8x1, 2x2) f</p>	<p>(8x1, 2x2^1) a</p>
	<p>(8x1, 2x2^1) b</p>	<p>(8x1, 2x2^1) c</p>	<p>(8x1, 2x2^1) d</p>	<p>(8x1, 2x2^1) e</p>

	<p>(8x1, 2x2²) a</p>	<p>(8x1, 2x2²) b</p>	<p>(8x1, 2x2²) c</p>	<p>(8x1, 2x2²) d</p>
	<p>(8x1, 2x2²) e</p>	<p>(6x1, 3x2) a</p>	<p>(6x1, 3x2) b</p>	<p>(6x1, 1x2, 2x2¹) a</p>
	<p>(6x1, 1x2, 2x2¹) b</p>	<p>(6x1, 1x2, 2x2¹) c</p>	<p>(6x1, 1x2, 2x2²) a</p>	<p>(6x1, 1x2, 2x2²) b</p>

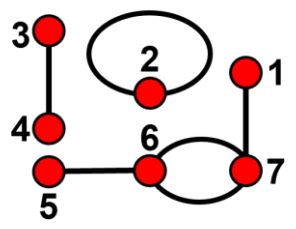
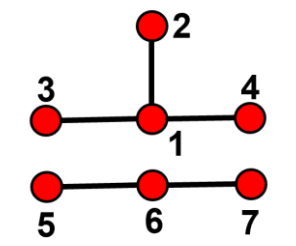
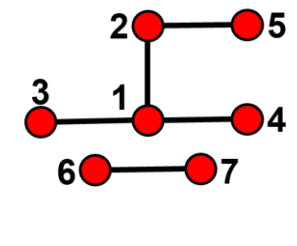
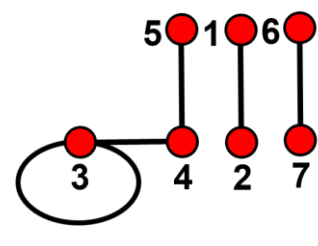
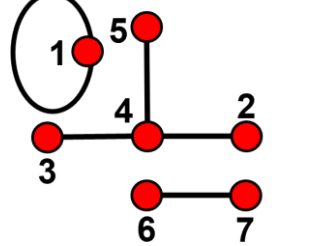
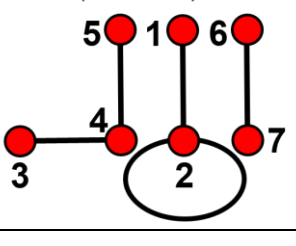
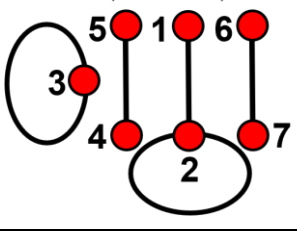
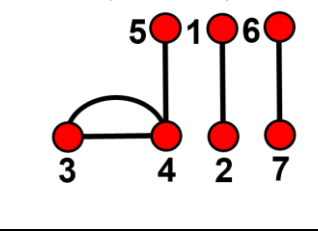
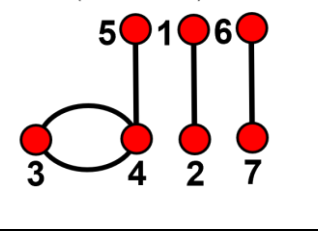
	(6x1, 1x2, 2x2 ²) c 			
${}^1V_4^2V_2^3V_2$	NG			
${}^1V_5^2V_1^3V_1$	(10x1) a 	(10x1) b 	(8x1, 1x2) a 	(8x1, 1x2) b 
	(8x1, 1x2) c 	(6x1, 2x2) 	(6x1, 2x2 ¹) 	(6x1, 2x2 ²) 
${}^1V_5^2V_2^3V_1$	NG			
${}^1V_r^2V_r^4V_r$				

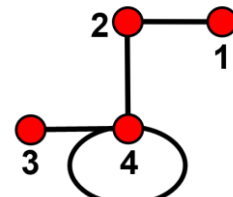
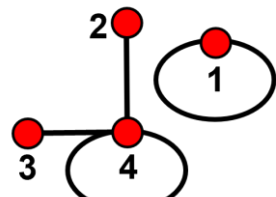
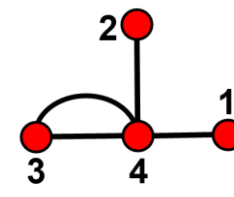
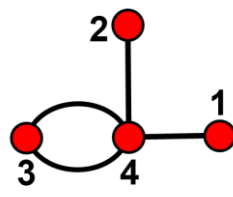
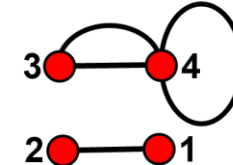
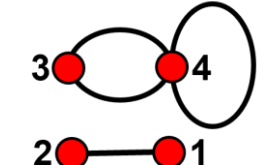
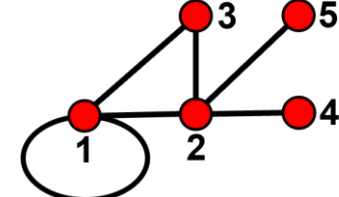
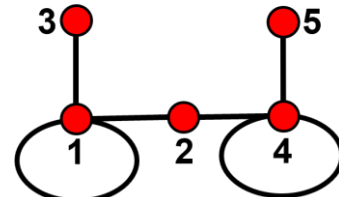
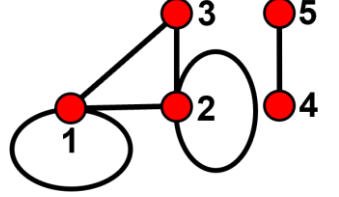
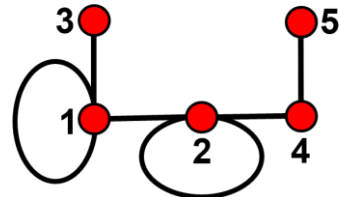
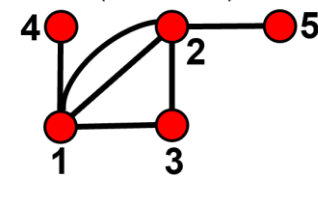
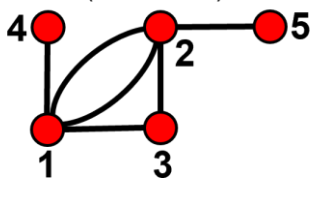
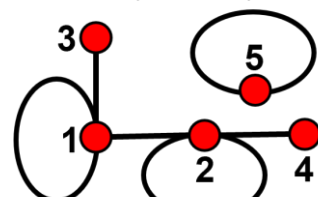
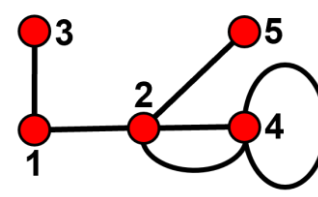
${}^1V_2^2V_1^4V_1$	<p>(6x1, 1x2)</p> 	<p>(4x1, 2x2)</p> 	<p>(4x1, 2x2')</p> 	<p>(4x1, 2x2'')</p> 
	<p>(2x1, 1x2, 2x2')</p> 	<p>(2x1, 1x2, 2x2'')</p> 		
${}^1V_2^2V_1^4V_2$	<p>(10x1, 1x2)</p> 	<p>(8x1, 2x2) a</p> 	<p>(8x1, 2x2) b</p> 	<p>(8x1, 2x2) c</p> 
	<p>(8x1, 2x2')</p> 	<p>(8x1, 2x2'')</p> 	<p>(6x1, 3x2)</p> 	<p>(6x1, 1x2, 2x2') a</p> 

	<p>(6x1, 1x2, 2x2¹) b</p>	<p>(6x1, 1x2, 2x2²) a</p>	<p>(6x1, 1x2, 2x2²) b</p>	<p>(4x1, 2x2, 2x2¹) a</p>
	<p>(4x1, 2x2, 2x2¹) b</p>	<p>(4x1, 2x2, 2x2¹) c</p>	<p>(4x1, 2x2, 2x2²) a</p>	<p>(4x1, 2x2, 2x2²) b</p>
	<p>(4x1, 2x2, 2x2²) c</p>	<p>(4x1, 4x2¹)</p>	<p>(4x1, 2x2¹, 2x2²) a</p>	<p>(4x1, 2x2¹, 2x2²) b</p>
	<p>(4x1, 4x2²)</p>	<p>(2x1, 3x2, 2x2¹)</p>	<p>(2x1, 3x2, 2x2²)</p>	<p>(2x1, 1x2, 4x2¹)</p>

	(2x1, 1x2, 2x2 ¹ , 2x2 ²) a 	(2x1, 1x2, 2x2 ¹ , 2x2 ²) b 	(2x1, 1x2, 4x2 ²) 	
${}^1V_2^2V_1^4V_3$	NG			
${}^1V_2^2V_1^4V_4$	NG			
${}^1V_2^2V_1^4V_5$	NG			
${}^1V_2^2V_2^4V_1$	(10x1) 	(8x1, 1x2) a 	(8x1, 1x2) b 	(8x1, 1x2) c
	(6x1, 2x2) 	(6x1, 2x2 ¹) 	(6x1, 2x2 ²) 	(4x1, 3x2)
	(4x1, 1x2, 2x2 ¹) a 	(4x1, 1x2, 2x2 ¹) b 	(4x1, 1x2, 2x2 ¹) c 	(4x1, 1x2, 2x2 ²) a

	<p>(4x1, 1x2, 2x2²) b</p>	<p>(4x1, 1x2, 2x2²) c</p>	<p>(2x1, 2x2, 2x2¹)</p>	<p>(2x1, 2x2, 2x2²)</p>
	<p>(2x1, 4x2¹)</p>	<p>(2x1, 2x2¹, 2x2²)</p>	<p>(2x1, 4x2²)</p>	
${}^1V_2^2V_2^4V_2$	NG			
${}^1V_2^2V_2^4V_3$	NG			
${}^1V_2^2V_2^4V_4$	NG			
${}^1V_2^2V_3^4V_1$	NG			
${}^1V_2^2V_3^4V_2$	NG			
${}^1V_2^2V_3^4V_3$	NG			
${}^1V_2^2V_4^4V_1$	NG			
${}^1V_2^2V_4^4V_2$	NG			
${}^1V_2^2V_5^4V_1$	NG			

${}^1V_4^2V_1^4V_1$	(10x1) 	(8x1, 1x2) a 	(8x1, 1x2) b 	(8x1, 1x2) c
	(6x1, 2x2) 	(6x1, 2x2^1) 	(6x1, 2x2^2) 	(4x1, 1x2, 2x2^1)
	(4x1, 1x2, 2x2^2) 			
${}^1V_4^2V_1^4V_2$	NG			
${}^1V_4^2V_1^4V_3$	NG			
${}^1V_4^2V_2^4V_1$	NG			
${}^1V_4^2V_2^4V_2$	NG			
${}^1V_4^2V_3^4V_1$	NG			
${}^1V_6^2V_1^4V_1$	NG			
${}^1V_r^3V_r^4V_r$				

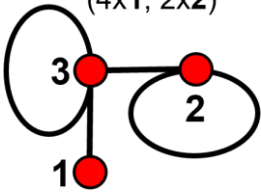
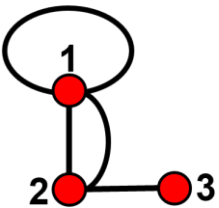
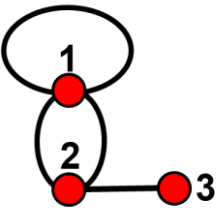
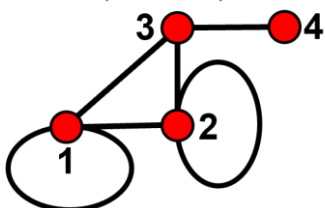
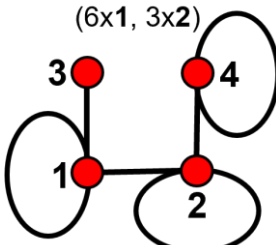
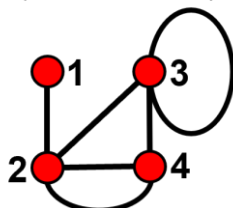
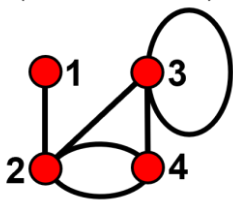
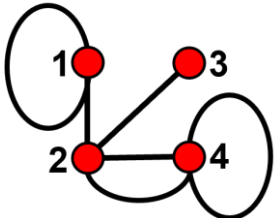
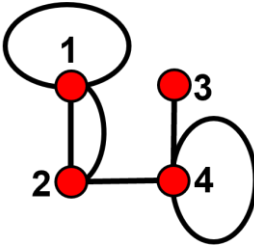
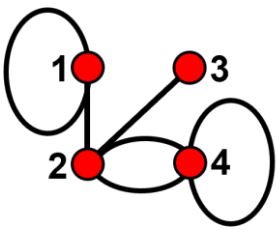
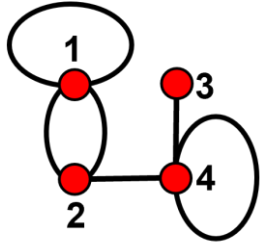
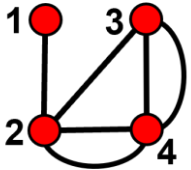
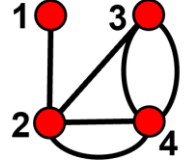
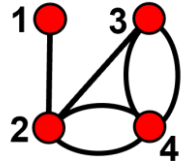
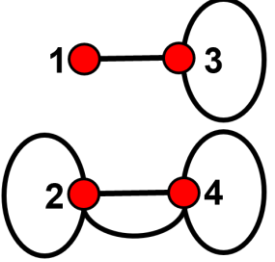
${}^1V_1{}^3V_1{}^4V_1$	<p>(4x1, 2x2)</p> 	<p>(2x1, 1x2, 2x2¹)</p> 	<p>(2x1, 1x2, 2x2²)</p> 	
${}^1V_1{}^3V_1{}^4V_2$	<p>(8x1, 2x2)</p> 	<p>(6x1, 3x2)</p> 	<p>(6x1, 1x2, 2x2¹)</p> 	<p>(6x1, 1x2, 2x2²)</p> 
	<p>(4x1, 2x2, 2x2¹) a</p> 	<p>(4x1, 2x2, 2x2¹) b</p> 	<p>(4x1, 2x2, 2x2²) a</p> 	<p>(4x1, 2x2, 2x2²) b</p> 
	<p>(4x1, 4x2¹)</p> 	<p>(4x1, 2x2¹, 2x2²)</p> 	<p>(4x1, 4x2²)</p> 	<p>(2x1, 3x2, 2x2¹)</p> 

	<p>(2x1, 3x2, 2x2²)</p>	<p>(2x1, 1x2, 4x2¹)</p>	<p>(2x1, 1x2, 2x2¹, 2x2²)</p>	<p>(2x1, 1x2, 4x2²)</p>
${}^1V_1{}^3V_1{}^4V_3$	<p>(12x1, 2x2)</p>	<p>(12x1, 2x2¹)</p>	<p>(12x1, 2x2²)</p>	<p>(10x1, 3x2) a</p>
	<p>(10x1, 3x2) b</p>	<p>(10x1, 3x2) c</p>	<p>(10x1, 1x2, 2x2¹) a</p>	<p>(10x1, 1x2, 2x2¹) b</p>
	<p>(10x1, 1x2, 2x2¹) c</p>	<p>(10x1, 1x2, 2x2²) a</p>	<p>(10x1, 1x2, 2x2²) b</p>	<p>(10x1, 1x2, 2x2²) c</p>

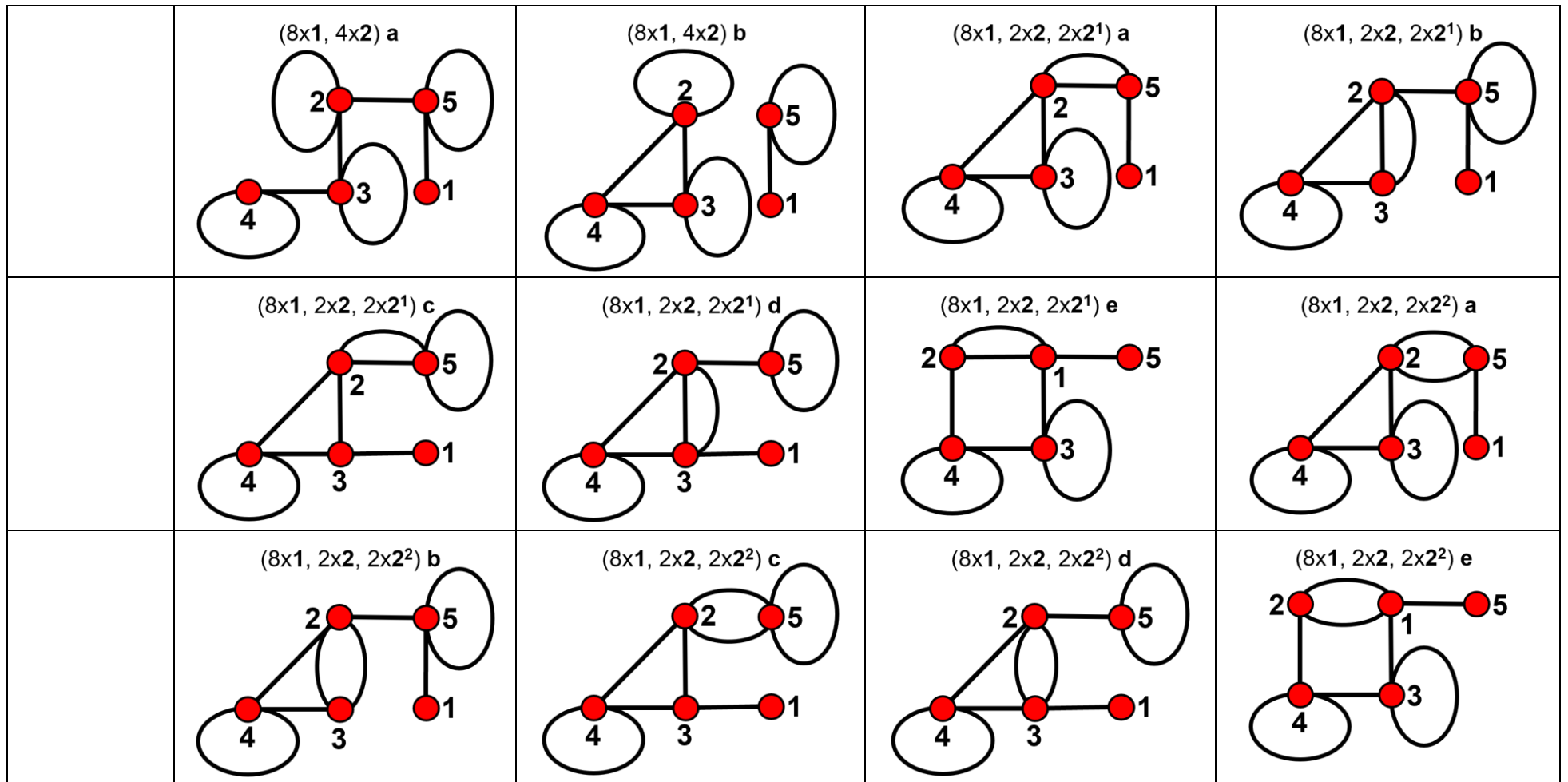

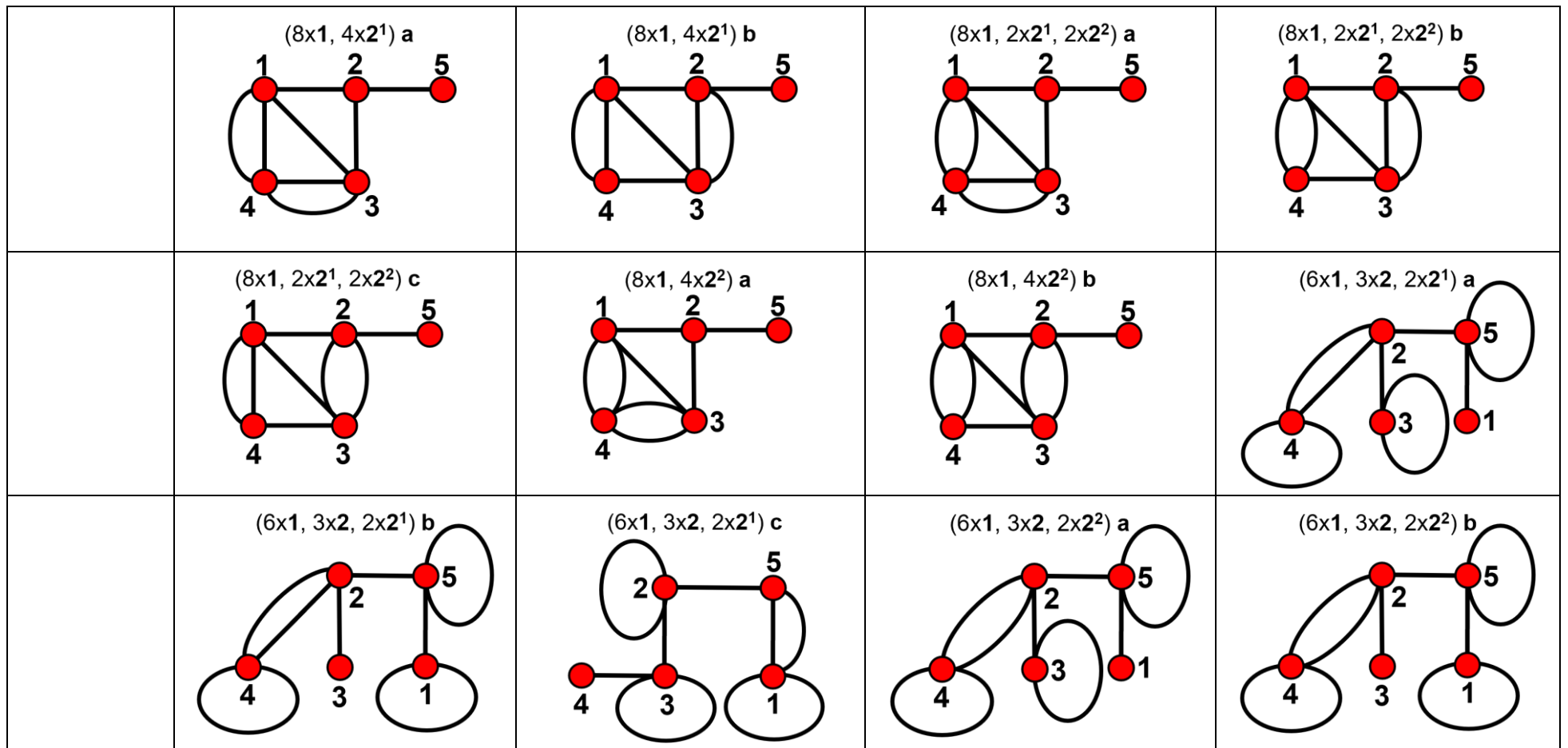

	<p>$(6x1, 3x2, 2x2^2)$ c</p>	<p>$(6x1, 1x2, 4x2^1)$ a</p>	<p>$(6x1, 1x2, 4x2^1)$ b</p>	<p>$(6x1, 1x2, 4x2^1)$ c</p>
	<p>$(6x1, 1x2, 4x2^1)$ d</p>	<p>$(6x1, 1x2, 2x2^1, 2x2^2)$ a</p>	<p>$(6x1, 1x2, 2x2^1, 2x2^2)$ b</p>	<p>$(6x1, 1x2, 2x2^1, 2x2^2)$ c</p>
	<p>$(6x1, 1x2, 2x2^1, 2x2^2)$ d</p>	<p>$(6x1, 1x2, 2x2^1, 2x2^2)$ e</p>	<p>$(6x1, 1x2, 2x2^1, 2x2^2)$ f</p>	<p>$(6x1, 1x2, 2x2^1, 2x2^2)$ g</p>
	<p>$(6x1, 1x2, 2x2^1, 2x2^2)$ h</p>	<p>$(6x1, 1x2, 4x2^2)$ a</p>	<p>$(6x1, 1x2, 4x2^2)$ b</p>	<p>$(6x1, 1x2, 4x2^2)$ c</p>

	<p>(6x1, 1x2, 4x2²) d</p>	<p>(4x1, 4x2, 2x2¹)</p>	<p>(4x1, 4x2, 2x2²)</p>	<p>(4x1, 2x2, 4x2¹) a</p>
	<p>(4x1, 2x2, 4x2¹) b</p>	<p>(4x1, 2x2, 4x2¹) c</p>	<p>(4x1, 2x2, 2x2¹, 2x2²) a</p>	<p>(4x1, 2x2, 2x2¹, 2x2²) b</p>
	<p>(4x1, 2x2, 2x2¹, 2x2²) c</p>	<p>(4x1, 2x2, 2x2¹, 2x2²) d</p>	<p>(4x1, 2x2, 2x2¹, 2x2²) e</p>	<p>(4x1, 2x2, 2x2¹, 2x2²) f</p>

	<p>(4x1, 2x2, 4x2²) a</p>	<p>(4x1, 2x2, 4x2²) b</p>	<p>(4x1, 2x2, 4x2²) c</p>	<p>(4x1, 6x2¹)</p>
	<p>(4x1, 4x2¹, 2x2²) a</p>	<p>(4x1, 4x2¹, 2x2²) b</p>	<p>(4x1, 4x2¹, 2x2²) c</p>	<p>(4x1, 2x2¹, 4x2²) a</p>
	<p>(4x1, 2x2¹, 4x2²) b</p>	<p>(4x1, 2x2¹, 4x2²) c</p>	<p>(4x1, 6x2²)</p>	<p>(2x1, 3x2, 4x2¹) a</p>

	<p>$(2x1, 3x2, 4x2^1)$ b</p>	<p>$(2x1, 3x2, 2x2^1, 2x2^2)$ a</p>	<p>$(2x1, 3x2, 2x2^1, 2x2^2)$ b</p>	<p>$(2x1, 3x2, 2x2^1, 2x2^2)$ c</p>
	<p>$(2x1, 3x2, 4x2^2)$ a</p>	<p>$(2x1, 3x2, 4x2^2)$ b</p>	<p>$(2x1, 1x2, 6x2^1)$ a</p>	<p>$(2x1, 1x2, 6x2^1)$ b</p>
	<p>$(2x1, 1x2, 4x2^1, 2x2^2)$ a</p>	<p>$(2x1, 1x2, 4x2^1, 2x2^2)$ b</p>	<p>$(2x1, 1x2, 4x2^1, 2x2^2)$ c</p>	<p>$(2x1, 1x2, 4x2^1, 2x2^2)$ d</p>

	(2x1, 1x2, 2x2 ¹ , 4x2 ²) a 	(2x1, 1x2, 2x2 ¹ , 4x2 ²) b 	(2x1, 1x2, 2x2 ¹ , 4x2 ²) c 	(2x1, 1x2, 2x2 ¹ , 4x2 ²) d
	(2x1, 1x2, 6x2 ²) a 	(2x1, 1x2, 6x2 ²) b 		
${}^1V_1{}^3V_1{}^4V_4$	NG			
${}^1V_1{}^3V_1{}^4V_5$	NG			
${}^1V_1{}^3V_1{}^4V_6$	NG			
${}^1V_1{}^3V_3{}^4V_1$	(14x1) 	(12x1, 1x2) 	(10x1, 2x2) 	(10x1, 2x2 ¹)

	<p>(10x1, 2x2²)</p>	<p>(8x1, 3x2) a</p>	<p>(8x1, 3x2) b</p>	<p>(8x1, 3x2) c</p>
	<p>(8x1, 1x2, 2x2¹) a</p>	<p>(8x1, 1x2, 2x2¹) b</p>	<p>(8x1, 1x2, 2x2¹) c</p>	<p>(8x1, 1x2, 2x2¹) d</p>
	<p>(8x1, 1x2, 2x2¹) e</p>	<p>(8x1, 1x2, 2x2²) a</p>	<p>(8x1, 1x2, 2x2²) b</p>	<p>(8x1, 1x2, 2x2²) c</p>

	<p>(8x1, 1x2, 2x2²) d</p>	<p>(8x1, 1x2, 2x2²) e</p>	<p>(6x1, 4x2) a</p>	<p>(6x1, 4x2) b</p>
	<p>(6x1, 2x2, 2x2¹) a</p>	<p>(6x1, 2x2, 2x2¹) b</p>	<p>(6x1, 2x2, 2x2¹) c</p>	<p>(6x1, 2x2, 2x2¹) d</p>
	<p>(6x1, 2x2, 2x2¹) e</p>	<p>(6x1, 2x2, 2x2¹) f</p>	<p>(6x1, 2x2, 2x2²) a</p>	<p>(6x1, 2x2, 2x2²) b</p>

	<p>(6x1, 2x2, 2x2²) c</p>	<p>(6x1, 2x2, 2x2²) d</p>	<p>(6x1, 2x2, 2x2²) e</p>	<p>(6x1, 2x2, 2x2²) f</p>
	<p>(6x1, 4x2¹) a</p>	<p>(6x1, 4x2¹) b</p>	<p>(6x1, 4x2¹) c</p>	<p>(6x1, 2x2¹, 2x2²) a</p>
	<p>(6x1, 2x2¹, 2x2²) b</p>	<p>(6x1, 2x2¹, 2x2²) c</p>	<p>(6x1, 2x2¹, 2x2²) d</p>	<p>(6x1, 2x2¹, 2x2²) e</p>
	<p>(6x1, 4x2²) a</p>	<p>(6x1, 4x2²) b</p>	<p>(6x1, 4x2²) c</p>	<p>(4x1, 3x2, 2x2¹) a</p>

	<p>(4x1, 3x2, 2x2¹) b</p>	<p>(4x1, 3x2, 2x2²) a</p>	<p>(4x1, 3x2, 2x2²) b</p>	<p>(4x1, 1x2, 4x2¹) a</p>
	<p>(4x1, 1x2, 4x2¹) b</p>	<p>(4x1, 1x2, 4x2¹) c</p>	<p>(4x1, 1x2, 2x2¹, 2x2²) a</p>	<p>(4x1, 1x2, 2x2¹, 2x2²) b</p>
	<p>(4x1, 1x2, 2x2¹, 2x2²) c</p>	<p>(4x1, 1x2, 2x2¹, 2x2²) d</p>	<p>(4x1, 1x2, 2x2¹, 2x2²) e</p>	<p>(4x1, 1x2, 4x2²) a</p>
	<p>(4x1, 1x2, 4x2²) b</p>	<p>(4x1, 1x2, 4x2²) c</p>		

${}^1V_1{}^3V_3{}^4V_2$	NG				
${}^1V_1{}^3V_3{}^4V_3$	NG				
${}^1V_1{}^3V_3{}^4V_4$	NG				
${}^1V_1{}^3V_5{}^4V_1$	NG				
${}^1V_1{}^3V_5{}^4V_2$	NG				
${}^1V_2{}^3V_2{}^4V_1$		<p>(10x1, 1x2)</p>	<p>(8x1, 2x2) a</p>	<p>(8x1, 2x2) b</p>	<p>(8x1, 2x2) c</p>
		<p>(8x1, 2x2¹) a</p>	<p>(8x1, 2x2¹) b</p>	<p>(8x1, 2x2²) a</p>	<p>(8x1, 2x2²) b</p>
		<p>(6x1, 3x2) a</p>	<p>(6x1, 3x2) b</p>	<p>(6x1, 3x2) c</p>	<p>(6x1, 1x2, 2x2¹) a</p>

	<p>(6x1, 1x2, 2x2¹) b</p>	<p>(6x1, 1x2, 2x2¹) c</p>	<p>(6x1, 1x2, 2x2¹) d</p>	<p>(6x1, 1x2, 2x2¹) e</p>
	<p>(6x1, 1x2, 2x2²) a</p>	<p>(6x1, 1x2, 2x2²) b</p>	<p>(6x1, 1x2, 2x2²) c</p>	<p>(6x1, 1x2, 2x2²) d</p>
	<p>(6x1, 1x2, 2x2²) e</p>	<p>(4x1, 2x2, 2x2¹) a</p>	<p>(4x1, 2x2, 2x2¹) b</p>	<p>(4x1, 2x2, 2x2²) a</p>

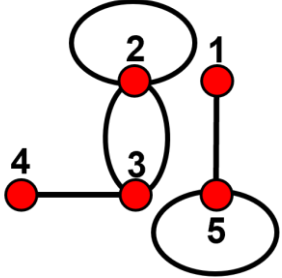
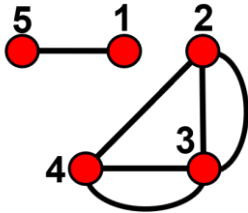
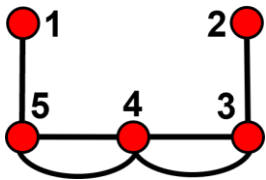
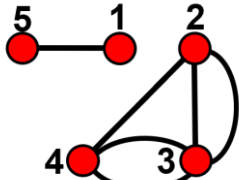
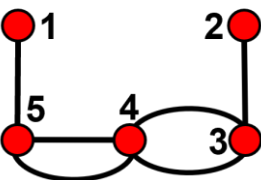
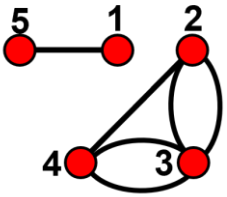
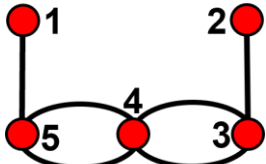
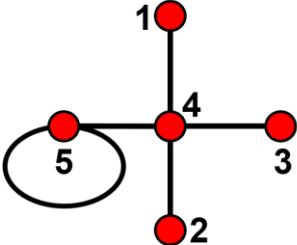
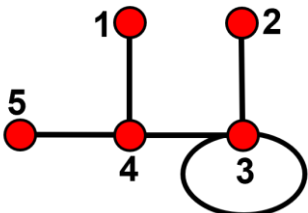
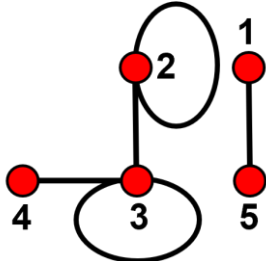
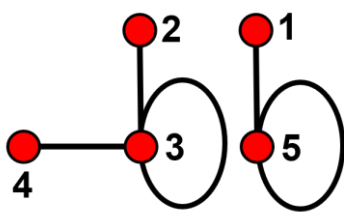

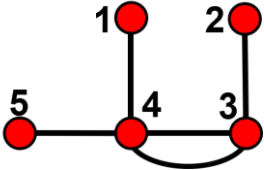
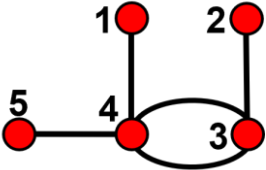
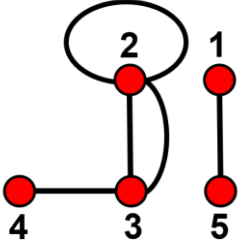
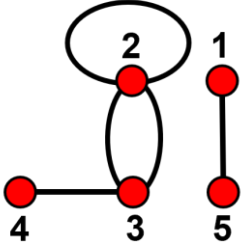
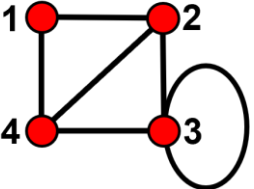
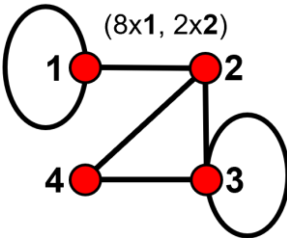
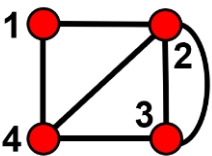
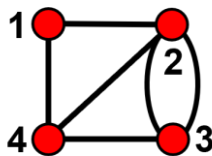
	(4x1, 2x2, 2x2 ²) b 	(4x1, 4x2 ¹) a 	(4x1, 4x2 ¹) b 	(4x1, 2x2 ¹ , 2x2 ²) a 
	(4x1, 2x2 ¹ , 2x2 ²) b 	(4x1, 4x2 ²) a 	(4x1, 4x2 ²) b 	
${}^1V_2^3V_2^4V_2$	NG			
${}^1V_2^3V_2^4V_3$	NG			
${}^1V_2^3V_2^4V_4$	NG			
${}^1V_2^3V_4^4V_1$	NG			
${}^1V_2^3V_4^4V_2$	NG			
${}^1V_3^3V_1^4V_1$	(8x1, 1x2) a 	(8x1, 1x2) b 	(6x1, 2x2) a 	(6x1, 2x2) b 

	(6x1, 2x2 ¹) 	(6x1, 2x2 ²) 	(4x1, 1x2, 2x2 ¹) 	(4x1, 1x2, 2x2 ²) 
${}^1V_3{}^3V_1{}^4V_2$	NG			
${}^1V_3{}^3V_1{}^4V_3$	NG			
${}^1V_3{}^3V_1{}^4V_4$	NG			
${}^1V_3{}^3V_3{}^4V_1$	NG			
${}^1V_3{}^3V_3{}^4V_2$	NG			
${}^1V_4{}^3V_2{}^4V_1$	NG			
${}^1V_4{}^3V_2{}^4V_2$	NG			
${}^1V_5{}^3V_1{}^4V_1$	NG			
${}^1V_5{}^3V_1{}^4V_2$	NG			
${}^2V_r{}^3V_r{}^4V_r$				
${}^2V_1{}^3V_2{}^4V_1$	(10x1, 1x2) 	(8x1, 2x2) 	(8x1, 2x2 ¹) 	(8x1, 2x2 ²) 

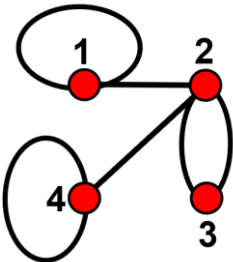
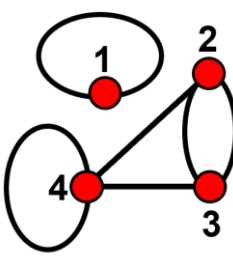
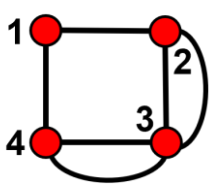
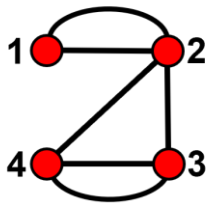
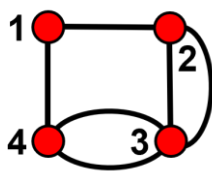
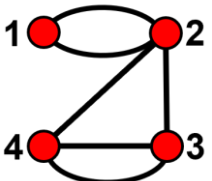
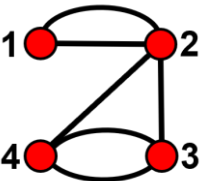
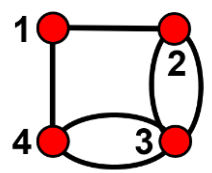
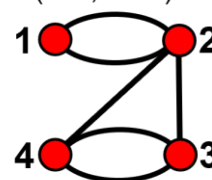
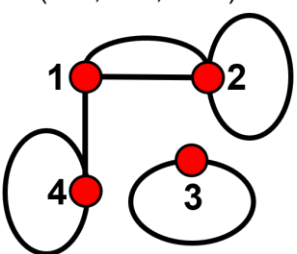
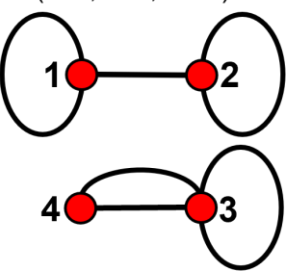
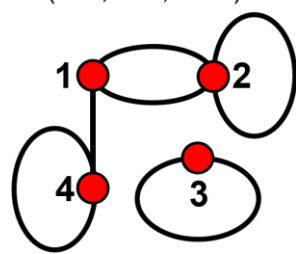
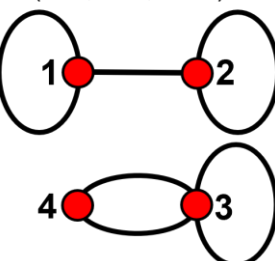
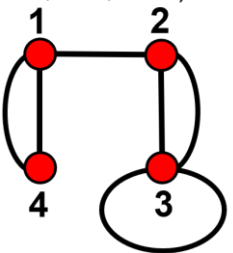
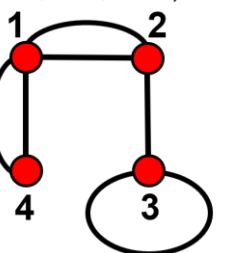
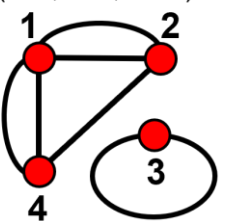
	<p>(6x1, 3x2)</p>	<p>(6x1, 1x2, 2x2¹) a</p>	<p>(6x1, 1x2, 2x2¹) b</p>	<p>(6x1, 1x2, 2x2²) a</p>
	<p>(6x1, 1x2, 2x2²) b</p>	<p>(4x1, 4x2)</p>	<p>(4x1, 2x2, 2x2¹) a</p>	<p>(4x1, 2x2, 2x2¹) b</p>
	<p>(4x1, 2x2, 2x2¹) c</p>	<p>(4x1, 2x2, 2x2¹) d</p>	<p>(4x1, 2x2, 2x2²) a</p>	<p>(4x1, 2x2, 2x2²) b</p>

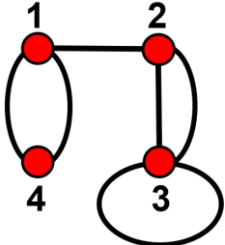
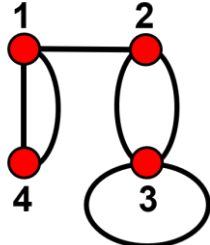
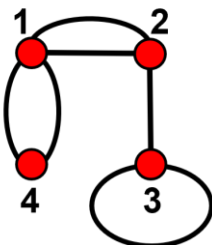
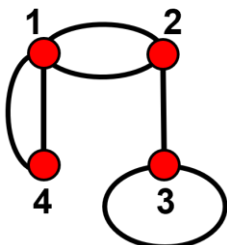
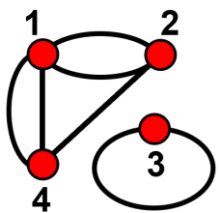
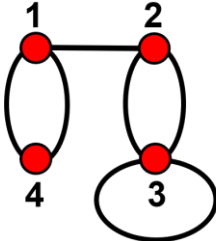
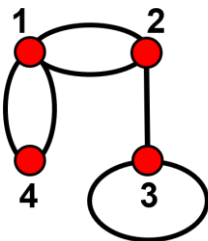
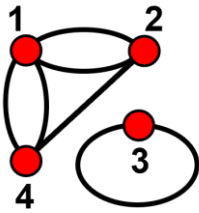
	<p>(4x1, 2x2, 2x2²) c</p> 	<p>(4x1, 2x2, 2x2²) d</p> 	<p>(4x1, 4x2¹) a</p> 	<p>(4x1, 4x2¹) b</p> 
	<p>(4x1, 2x2¹, 2x2²) a</p> 	<p>(4x1, 2x2¹, 2x2²) b</p> 	<p>(4x1, 2x2¹, 2x2²) c</p> 	<p>(4x1, 4x2²) a</p> 
	<p>(4x1, 4x2²) b</p> 	<p>(2x1, 3x2, 2x2¹) a</p> 	<p>(2x1, 3x2, 2x2¹) b</p> 	<p>(2x1, 3x2, 2x2²) a</p> 
	<p>(2x1, 3x2, 2x2²) b</p> 	<p>(2x1, 1x2, 4x2¹) a</p> 	<p>(2x1, 1x2, 4x2¹) b</p> 	<p>(2x1, 1x2, 4x2¹) c</p> 

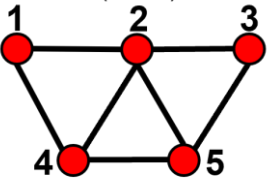
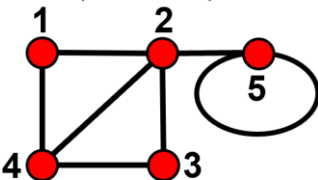
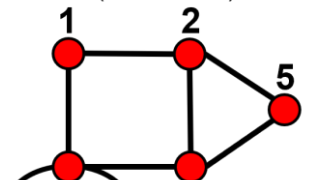
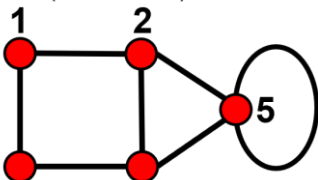
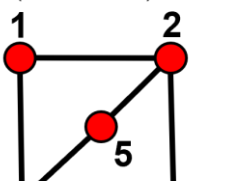
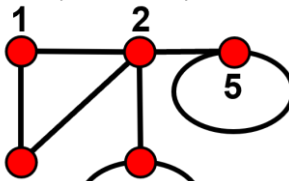
	(2x1, 1x2, 2x2 ¹ , 2x2 ²) a 	(2x1, 1x2, 2x2 ¹ , 2x2 ²) b 	(2x1, 1x2, 2x2 ¹ , 2x2 ²) c 	(2x1, 1x2, 2x2 ¹ , 2x2 ²) d 
	(2x1, 1x2, 2x2 ¹ , 2x2 ²) e 	(2x1, 1x2, 4x2 ²) a 	(2x1, 1x2, 4x2 ²) b 	(2x1, 1x2, 4x2 ²) c 
${}^2V_1{}^3V_2{}^4V_2$	NG			
${}^2V_1{}^3V_2{}^4V_3$	NG			
${}^2V_1{}^3V_2{}^4V_4$	NG			
${}^2V_1{}^3V_2{}^4V_5$	NG			
${}^2V_1{}^3V_4{}^4V_1$	NG			
${}^2V_1{}^3V_4{}^4V_2$	NG			
${}^2V_1{}^3V_4{}^4V_3$	NG			
${}^2V_1{}^3V_6{}^4V_1$	NG			

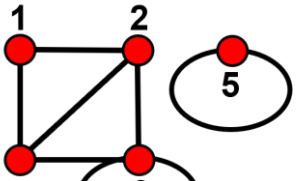
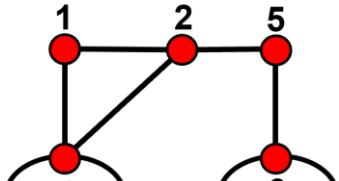
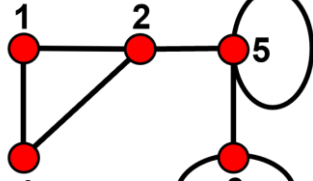
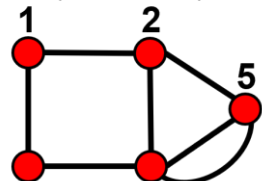
${}^2V_2{}^3V_2{}^4V_1$	<p>(14x1)</p> 	<p>(12x1, 1x2) a</p> 	<p>(12x1, 1x2) b</p> 	<p>(12x1, 1x2) c</p> 
	<p>(12x1, 1x2) d</p> 	<p>(10x1, 2x2) a</p> 	<p>(10x1, 2x2) b</p> 	<p>(10x1, 2x2) c</p> 
	<p>(10x1, 2x2) d</p> 	<p>(10x1, 2x2) e</p> 	<p>(10x1, 2x2) f</p> 	<p>(10x1, 2x2¹) a</p> 

	<p>(10x1, 2x2¹) b</p>	<p>(10x1, 2x2¹) c</p>	<p>(10x1, 2x2¹) d</p>	<p>(10x1, 2x2¹) e</p>
	<p>(10x1, 2x2²) a</p>	<p>(10x1, 2x2²) b</p>	<p>(10x1, 2x2²) c</p>	<p>(10x1, 2x2²) d</p>
	<p>(10x1, 2x2²) e</p>	<p>(8x1, 3x2) a</p>	<p>(8x1, 3x2) b</p>	<p>(8x1, 3x2) c</p>

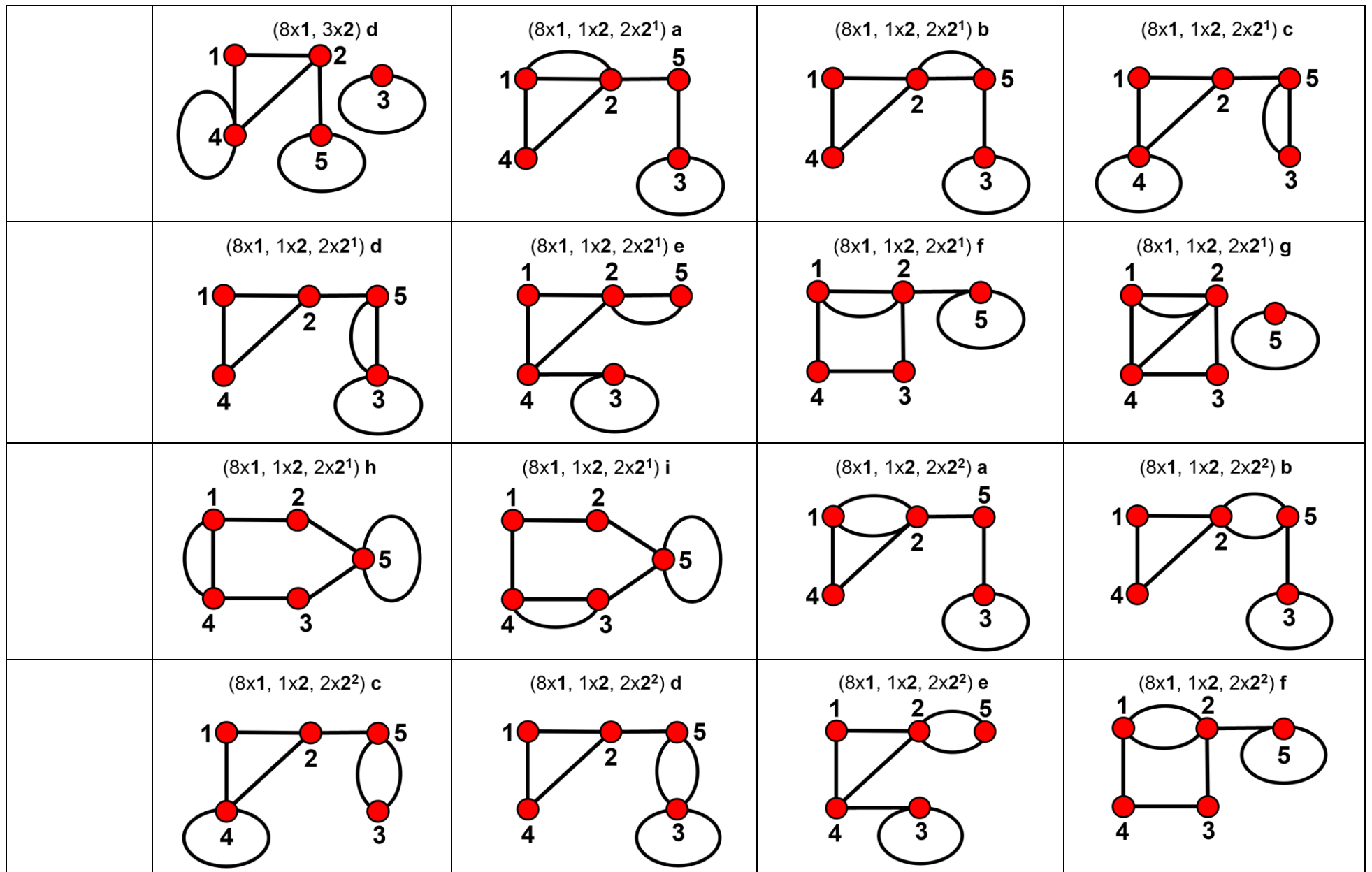

	<p>(8x1, 1x2, 2x2²) g</p>	<p>(8x1, 1x2, 2x2²) h</p>	<p>(8x1, 1x2, 2x2²) i</p>	<p>(6x1, 4x2)</p>
	<p>(6x1, 2x2, 2x2¹) a</p>	<p>(6x1, 2x2, 2x2¹) b</p>	<p>(6x1, 2x2, 2x2¹) c</p>	<p>(6x1, 2x2, 2x2¹) d</p>
	<p>(6x1, 2x2, 2x2¹) e</p>	<p>(6x1, 2x2, 2x2¹) f</p>	<p>(6x1, 2x2, 2x2²) a</p>	<p>(6x1, 2x2, 2x2²) b</p>

	<p>(6x1, 2x2, 2x2²) c</p>	<p>(6x1, 2x2, 2x2²) d</p>	<p>(6x1, 2x2, 2x2²) e</p>	<p>(6x1, 2x2, 2x2²) f</p>
	<p>(6x1, 4x2¹) a</p>	<p>(6x1, 4x2¹) b</p>	<p>(6x1, 4x2¹) c</p>	<p>(6x1, 2x2¹, 2x2²) a</p>
	<p>(6x1, 2x2¹, 2x2²) b</p>	<p>(6x1, 2x2¹, 2x2²) c</p>	<p>(6x1, 2x2¹, 2x2²) d</p>	<p>(6x1, 2x2¹, 2x2²) e</p>

	<p>(6x1, 4x2²) a</p>	<p>(6x1, 4x2²) b</p>	<p>(6x1, 4x2²) c</p>	<p>(4x1, 5x2)</p>
	<p>(4x1, 3x2, 2x2¹) a</p>	<p>(4x1, 3x2, 2x2¹) b</p>	<p>(4x1, 3x2, 2x2¹) c</p>	<p>(4x1, 3x2, 2x2¹) d</p>
	<p>(4x1, 3x2, 2x2²) e</p>	<p>(4x1, 3x2, 2x2¹) f</p>	<p>(4x1, 3x2, 2x2²) a</p>	<p>(4x1, 3x2, 2x2²) b</p>

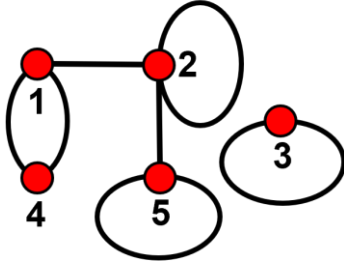
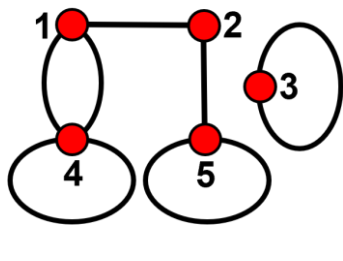
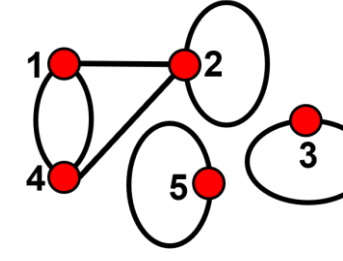
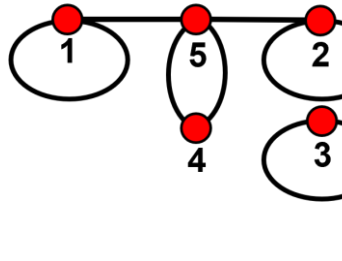
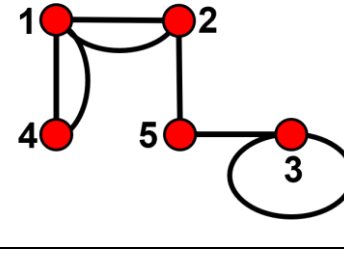
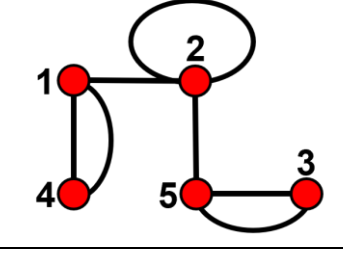
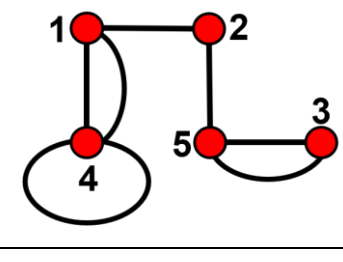
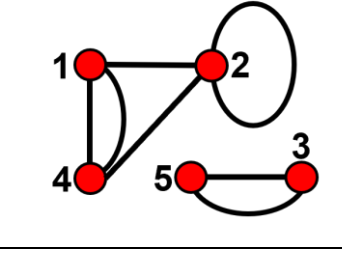
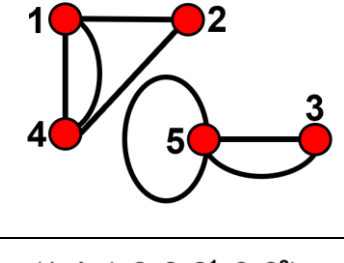
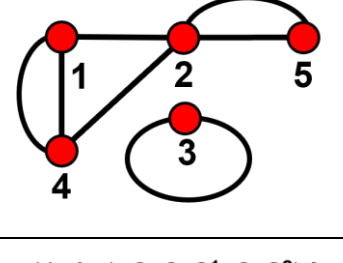
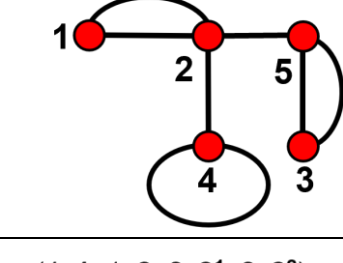
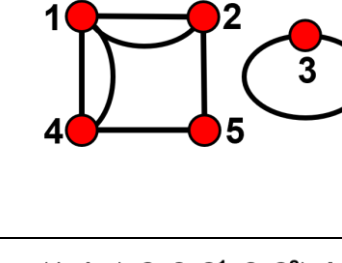
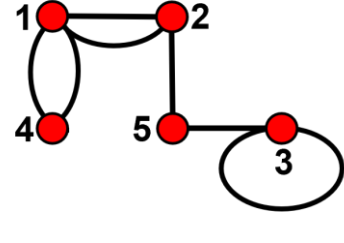
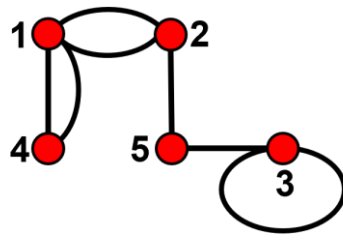
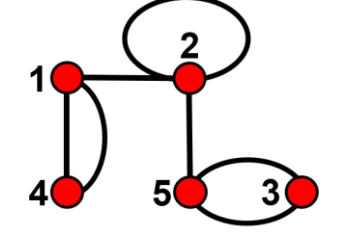
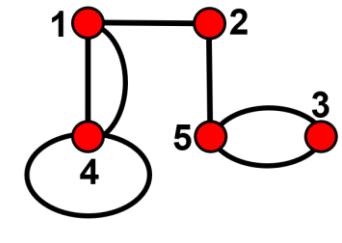
	<p>(4x1, 3x2, 2x2²) c</p> 	<p>(4x1, 3x2, 2x2²) d</p> 	<p>(4x1, 3x2, 2x2²) e</p> 	<p>(4x1, 3x2, 2x2²) f</p> 
	<p>(4x1, 1x2, 4x2¹) a</p> 	<p>(4x1, 1x2, 4x2¹) b</p> 	<p>(4x1, 1x2, 4x2¹) c</p> 	<p>(4x1, 1x2, 4x2¹) d</p> 
	<p>(4x1, 1x2, 4x2¹) e</p> 	<p>(4x1, 1x2, 4x2¹) f</p> 	<p>(4x1, 1x2, 4x2¹) g</p> 	<p>(4x1, 1x2, 4x2¹) h</p> 
	<p>(4x1, 1x2, 2x2¹, 2x2²) a</p> 	<p>(4x1, 1x2, 2x2¹, 2x2²) b</p> 	<p>(4x1, 1x2, 2x2¹, 2x2²) c</p> 	<p>(4x1, 1x2, 2x2¹, 2x2²) d</p> 

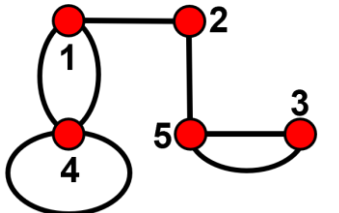
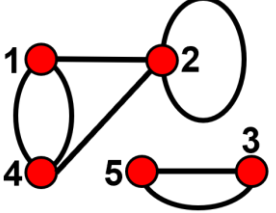
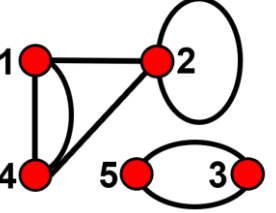
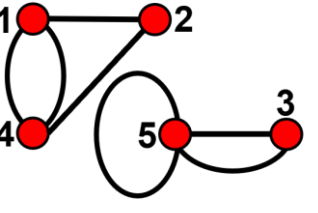
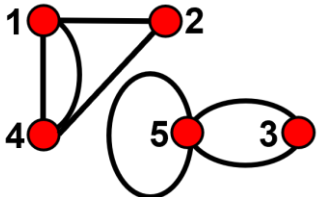
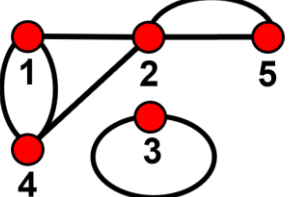
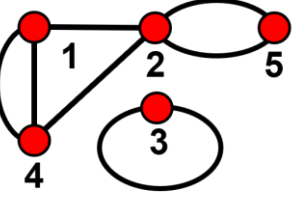
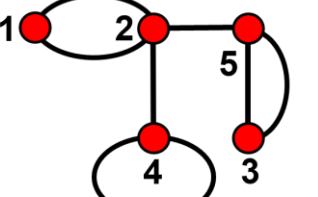
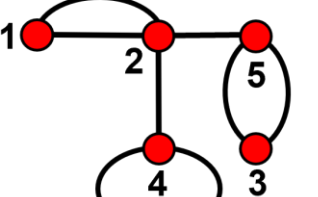
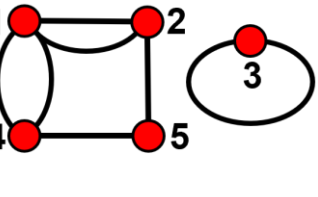
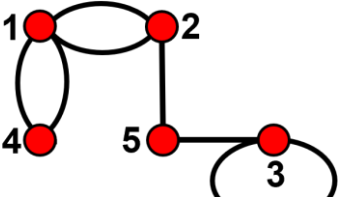
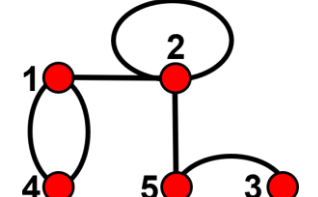
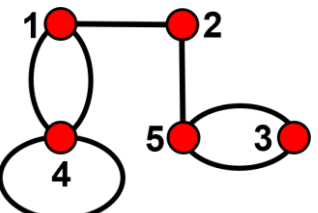
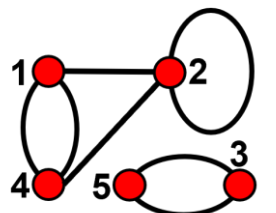
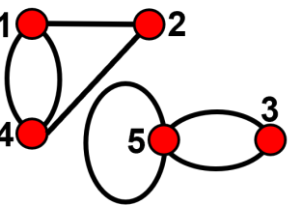
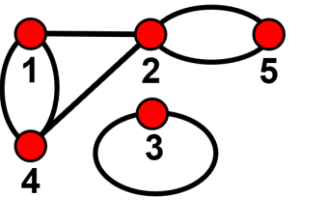
	<p>($4x1, 1x2, 2x2^1, 2x2^2$) e</p> 	<p>($4x1, 1x2, 2x2^1, 2x2^2$) f</p> 	<p>($4x1, 1x2, 2x2^1, 2x2^2$) g</p> 	<p>($4x1, 1x2, 2x2^1, 2x2^2$) h</p> 
	<p>($4x1, 1x2, 2x2^1, 2x2^2$) i</p> 	<p>($4x1, 1x2, 2x2^1, 2x2^2$) j</p> 	<p>($4x1, 1x2, 2x2^1, 2x2^2$) k</p> 	<p>($4x1, 1x2, 2x2^1, 2x2^2$) l</p> 
	<p>($4x1, 1x2, 2x2^1, 2x2^2$) m</p> 	<p>($4x1, 1x2, 2x2^1, 2x2^2$) n</p> 	<p>($4x1, 1x2, 4x2^2$) a</p> 	<p>($4x1, 1x2, 4x2^2$) b</p> 
	<p>($4x1, 1x2, 4x2^2$) c</p> 	<p>($4x1, 1x2, 4x2^2$) d</p> 	<p>($4x1, 1x2, 4x2^2$) e</p> 	<p>($4x1, 1x2, 4x2^2$) f</p> 

	<p>$(4x1, 1x2, 4x2^2)$ g</p>	<p>$(4x1, 1x2, 4x2^2)$ h</p>	<p>$(2x1, 4x2, 2x2^1)$ a</p>	<p>$(2x1, 4x2, 2x2^1)$ b</p>
	<p>$(2x1, 4x2, 2x2^2)$ a</p>	<p>$(2x1, 4x2, 2x2^2)$ b</p>	<p>$(2x1, 2x2, 4x2^1)$ a</p>	<p>$(2x1, 2x2, 4x2^1)$ b</p>
	<p>$(2x1, 2x2, 4x2^1)$ c</p>	<p>$(2x1, 2x2, 4x2^1)$ d</p>	<p>$(2x1, 2x2, 4x2^1)$ e</p>	<p>$(2x1, 2x2, 4x2^1)$ f</p>
	<p>$(2x1, 2x2, 2x2^1, 2x2^2)$ a</p>	<p>$(2x1, 2x2, 2x2^1, 2x2^2)$ b</p>	<p>$(2x1, 2x2, 2x2^1, 2x2^2)$ c</p>	<p>$(2x1, 2x2, 2x2^1, 2x2^2)$ d</p>

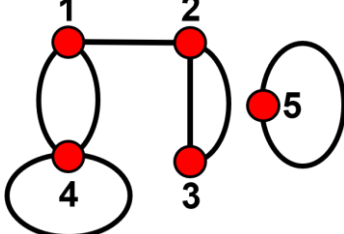
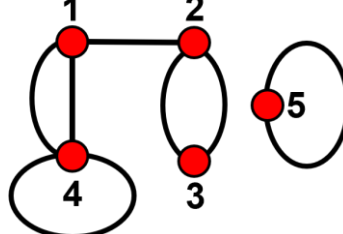
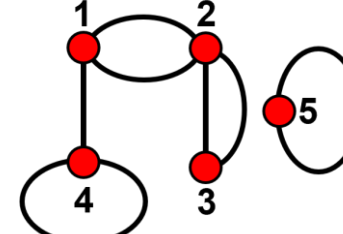
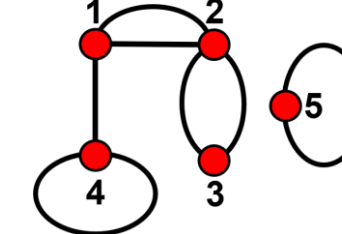
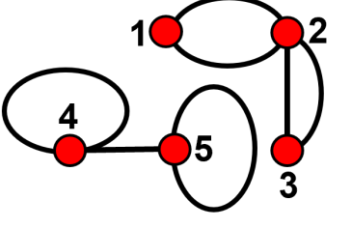
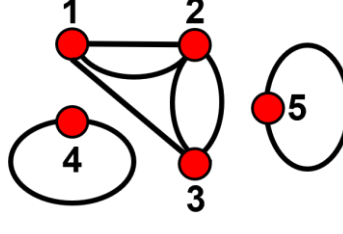
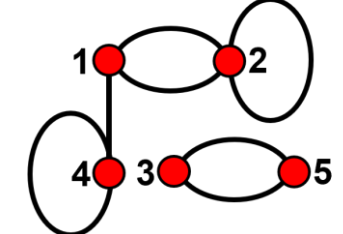
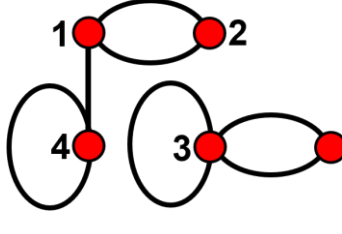
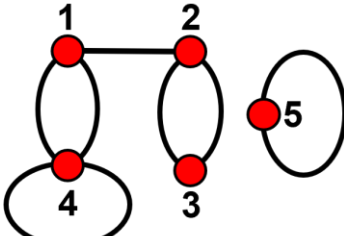
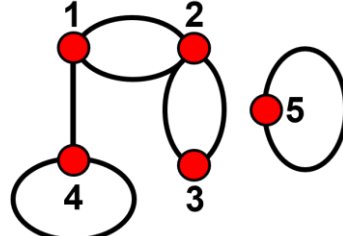
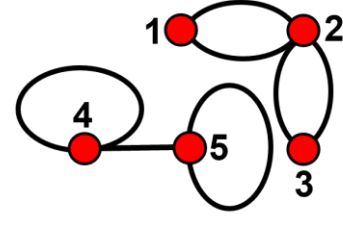
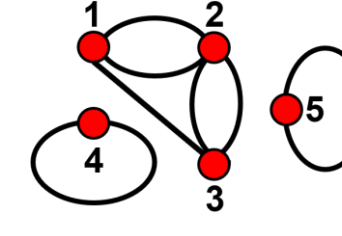
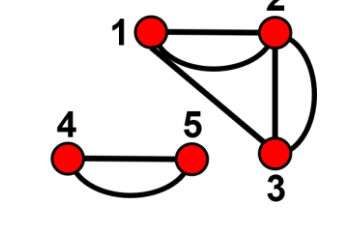
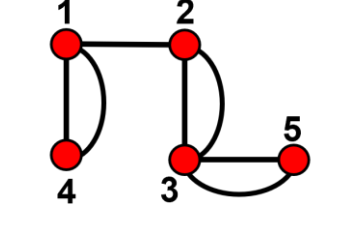
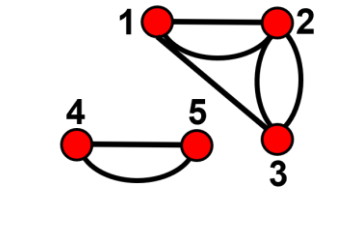
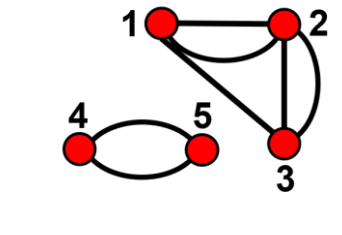
	<p>($2x1, 2x2, 2x2^1, 2x2^2$) e</p> 	<p>($2x1, 2x2, 2x2^1, 2x2^2$) f</p> 	<p>($2x1, 2x2, 2x2^1, 2x2^2$) g</p> 	<p>($2x1, 2x2, 2x2^1, 2x2^2$) h</p> 
	<p>($2x1, 2x2, 2x2^1, 2x2^2$) i</p> 	<p>($2x1, 2x2, 2x2^1, 2x2^2$) j</p> 	<p>($2x1, 2x2, 4x2^2$) a</p> 	<p>($2x1, 2x2, 4x2^2$) b</p> 
	<p>($2x1, 2x2, 4x2^2$) c</p> 	<p>($2x1, 2x2, 4x2^2$) d</p> 	<p>($2x1, 2x2, 4x2^2$) e</p> 	<p>($2x1, 2x2, 4x2^2$) f</p> 
	<p>($2x1, 6x2^1$) a</p> 	<p>($2x1, 6x2^1$) b</p> 	<p>($2x1, 4x2^1, 2x2^2$) a</p> 	<p>($2x1, 4x2^1, 2x2^2$) b</p> 

	(2x1, 4x2 ¹ , 2x2 ²) c 	(2x1, 4x2 ¹ , 2x2 ²) d 	(2x1, 4x2 ¹ , 2x2 ²) e 	(2x1, 2x2 ¹ , 4x2 ²) a
	(2x1, 2x2 ¹ , 4x2 ²) b 	(2x1, 2x2 ¹ , 4x2 ²) c 	(2x1, 2x2 ¹ , 4x2 ²) d 	(2x1, 2x2 ¹ , 4x2 ²) e
	(2x1, 6x2 ²) a 	(2x1, 6x2 ²) b 		
${}^2V_2{}^3V_2{}^4V_2$	NG			
${}^2V_2{}^3V_2{}^4V_3$	NG			
${}^2V_2{}^3V_2{}^4V_4$	NG			
${}^2V_2{}^3V_4{}^4V_1$	NG			
${}^2V_2{}^3V_4{}^4V_2$	NG			
${}^2V_3{}^3V_2{}^4V_1$	NG			

${}^2V_3{}^3V_2{}^4V_2$	NG			
${}^2V_3{}^3V_2{}^4V_3$	NG			
${}^2V_3{}^3V_4{}^4V_1$	NG			
${}^2V_4{}^3V_2{}^4V_1$	NG			
${}^2V_4{}^3V_2{}^4V_2$	NG			
${}^2V_5{}^3V_2{}^4V_1$	NG			
Rank 4				
${}^1V_r{}^2V_r{}^3V_r{}^4V_r$				
${}^1V_1{}^2V_1{}^3V_1{}^4V_1$	<p>(8x1, 1x2)</p>	<p>(6x1, 2x2) a</p>	<p>(6x1, 2x2) b</p>	<p>(6x1, 2x2¹)</p>
	<p>(6x1, 2x2²)</p>	<p>(4x1, 3x2)</p>	<p>(4x1, 1x2, 2x2¹) a</p>	<p>(4x1, 1x2, 2x2¹) b</p>

	<p>(4x1, 1x2, 2x2¹) c</p>	<p>(4x1, 1x2, 2x2²) a</p>	<p>(4x1, 1x2, 2x2²) b</p>	<p>(4x1, 1x2, 2x2²) c</p>
	<p>(2x1, 2x2, 2x2¹) a</p>	<p>(2x1, 2x2, 2x2¹) b</p>	<p>(2x1, 2x2, 2x2²) a</p>	<p>(2x1, 2x2, 2x2²) b</p>
	<p>(2x1, 4x2¹)</p>	<p>(2x1, 2x2¹, 2x2²) a</p>	<p>(2x1, 2x2¹, 2x2²) b</p>	<p>(2x1, 4x2²)</p>
${}^1V_1^2V_1^3V_1^4V_2$	<p>(12x1, 1x2)</p>	<p>(10x1, 2x2) a</p>	<p>(10x1, 2x2) b</p>	<p>(10x1, 2x2) c</p>

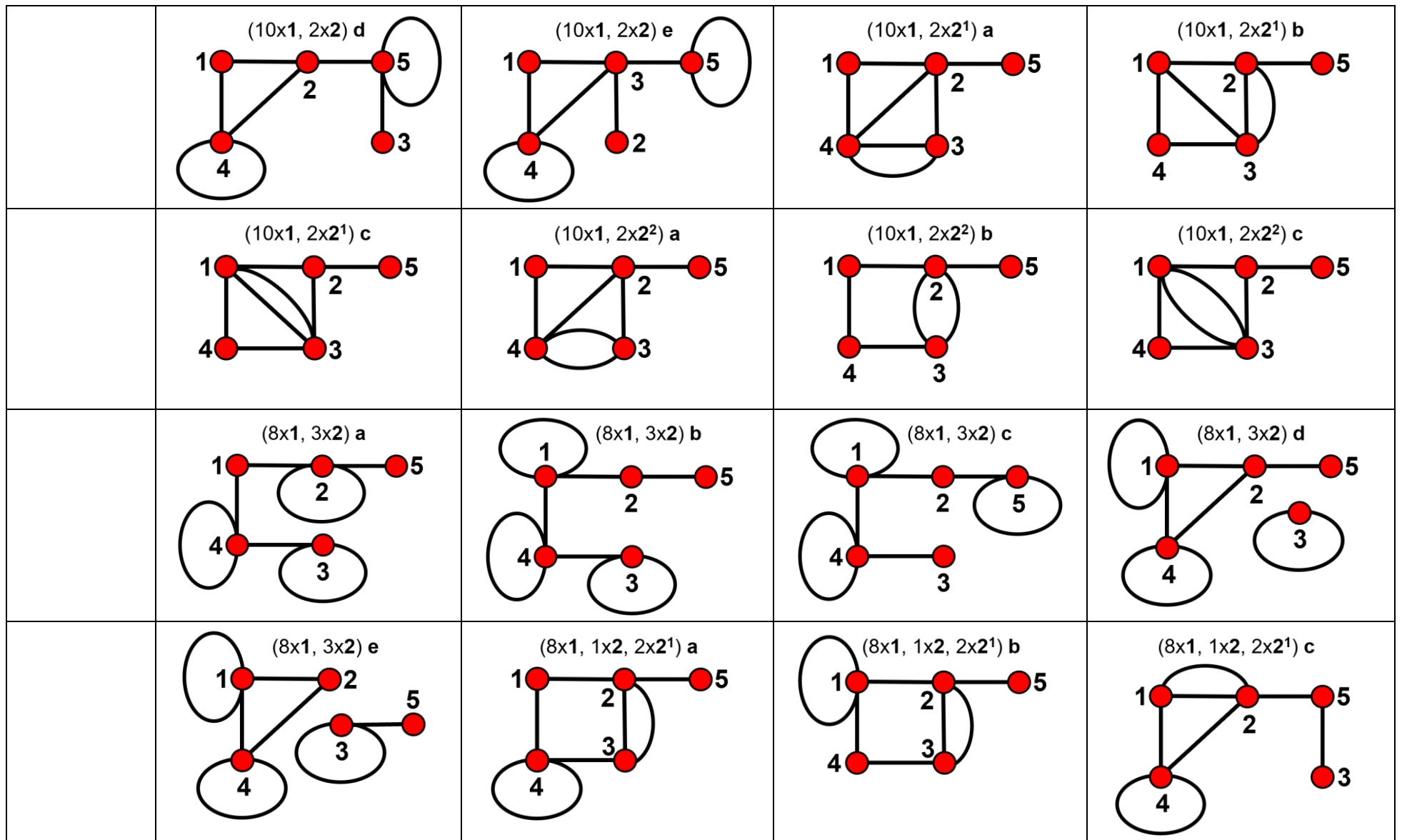

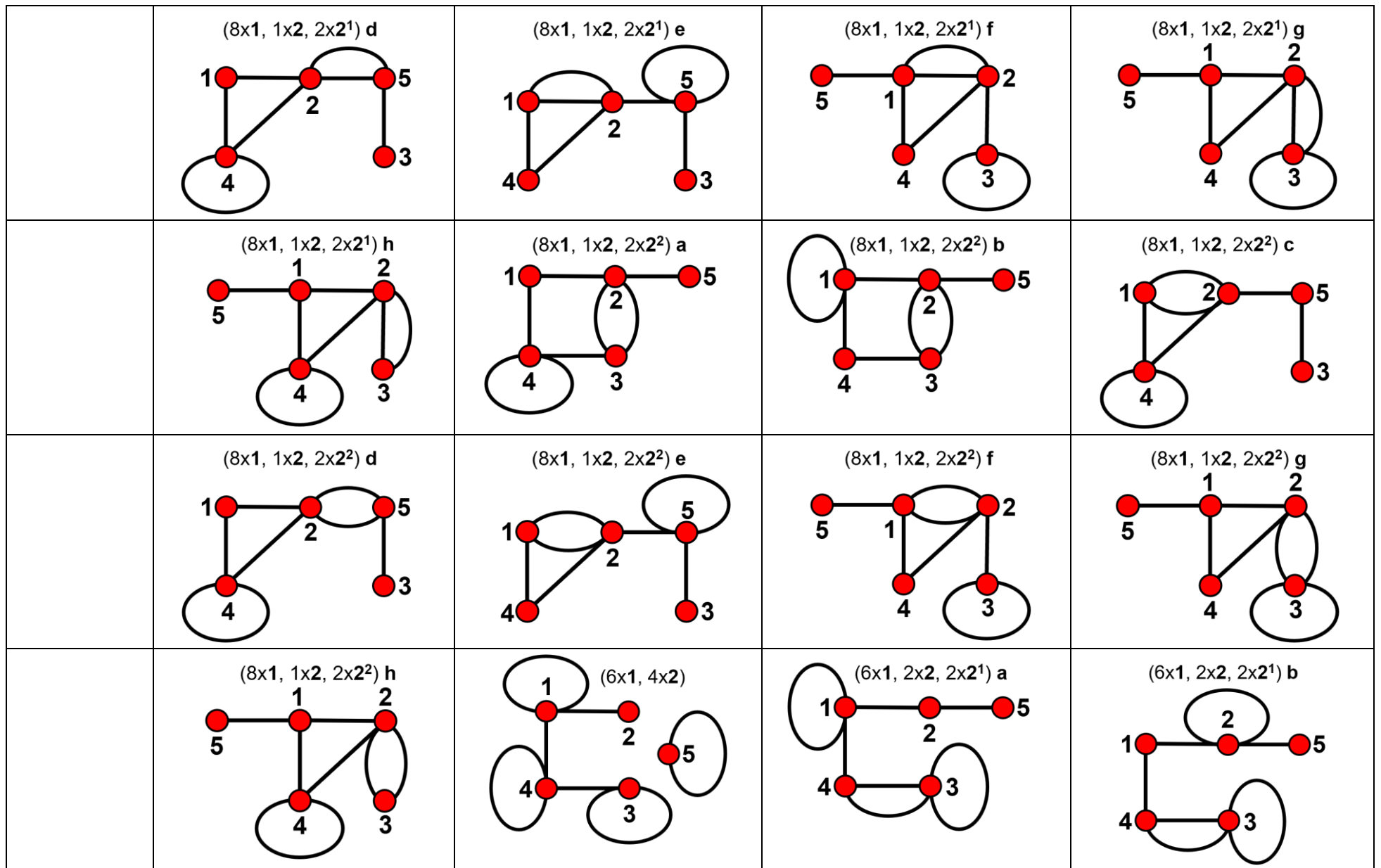

	<p>(6x1, 2x2, 2x2¹) c</p>	<p>(6x1, 2x2, 2x2¹) d</p>	<p>(6x1, 2x2, 2x2¹) e</p>	<p>(6x1, 2x2, 2x2¹) f</p>
	<p>(6x1, 2x2, 2x2¹) g</p>	<p>(6x1, 2x2, 2x2¹) h</p>	<p>(6x1, 2x2, 2x2²) a</p>	<p>(6x1, 2x2, 2x2²) b</p>
	<p>(6x1, 2x2, 2x2²) c</p>	<p>(6x1, 2x2, 2x2²) d</p>	<p>(6x1, 2x2, 2x2²) e</p>	<p>(6x1, 2x2, 2x2²) f</p>
	<p>(6x1, 2x2, 2x2²) g</p>	<p>(6x1, 2x2, 2x2²) h</p>	<p>(6x1, 4x2¹) a</p>	<p>(6x1, 4x2¹) b</p>

	<p>(6x1, 4x2¹) c</p>	<p>(6x1, 2x2¹, 2x2²) a</p>	<p>(6x1, 2x2¹, 2x2²) b</p>	<p>(6x1, 2x2¹, 2x2²) c</p>
	<p>(6x1, 2x2¹, 2x2²) d</p>	<p>(6x1, 2x2¹, 2x2²) e</p>	<p>(6x1, 2x2¹, 2x2²) f</p>	<p>(6x1, 4x2²) a</p>
	<p>(6x1, 4x2²) b</p>	<p>(6x1, 4x2²) c</p>	<p>(4x1, 3x2, 2x2¹) a</p>	<p>(4x1, 3x2, 2x2¹) b</p>

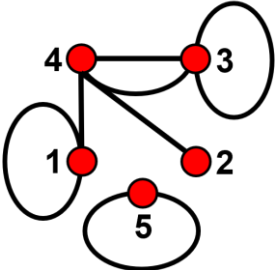
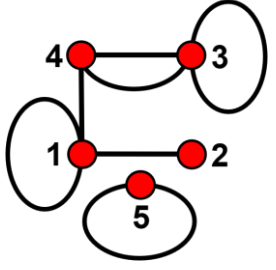
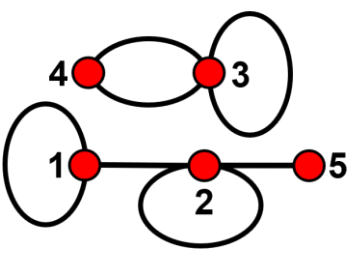
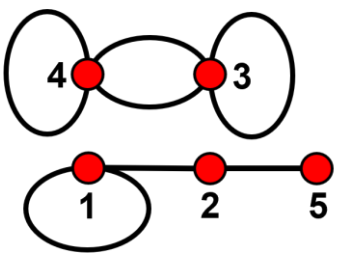
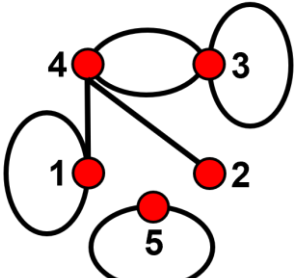
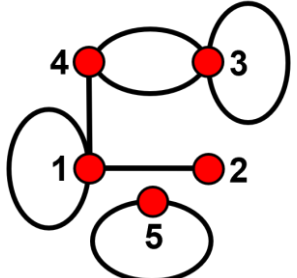
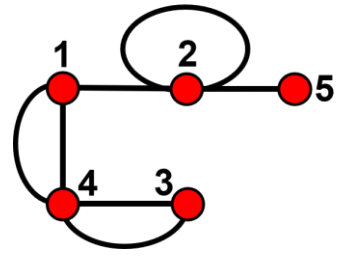
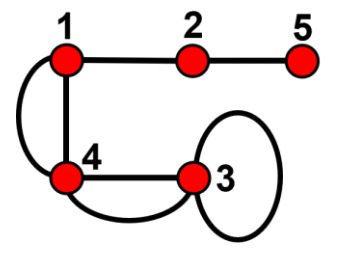
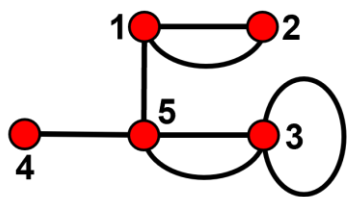
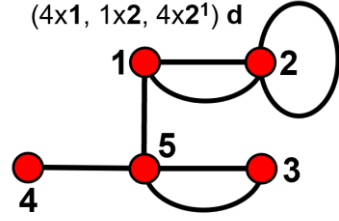
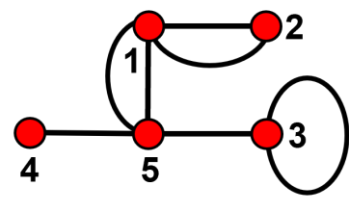
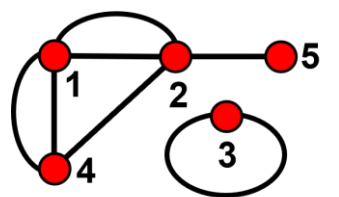
	<p>$(4x1, 3x2, 2x2^1)$ c</p> 	<p>$(4x1, 3x2, 2x2^1)$ d</p> 	<p>$(4x1, 3x2, 2x2^2)$ a</p> 	<p>$(4x1, 3x2, 2x2^2)$ b</p> 
	<p>$(4x1, 3x2, 2x2^2)$ c</p> 	<p>$(4x1, 3x2, 2x2^2)$ d</p> 	<p>$(4x1, 1x2, 4x2^1)$ a</p> 	<p>$(4x1, 1x2, 4x2^1)$ b</p> 
	<p>$(4x1, 1x2, 4x2^1)$ c</p> 	<p>$(4x1, 1x2, 4x2^1)$ d</p> 	<p>$(4x1, 1x2, 4x2^1)$ e</p> 	<p>$(4x1, 1x2, 4x2^1)$ f</p> 

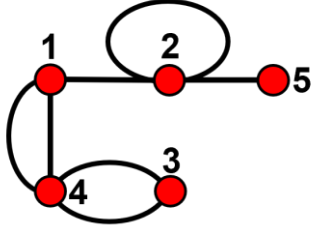
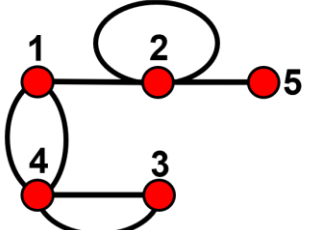
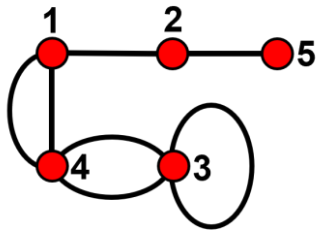
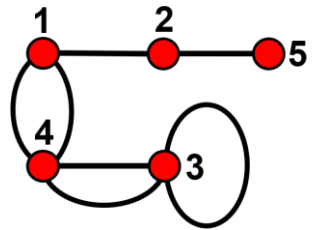
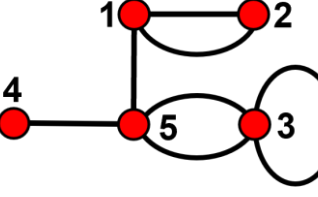
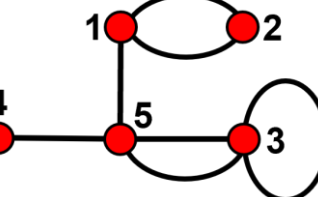
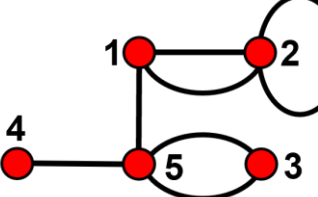
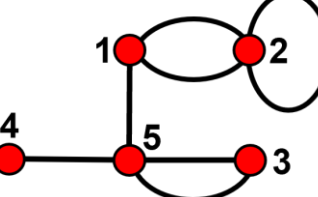
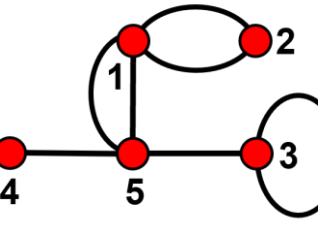
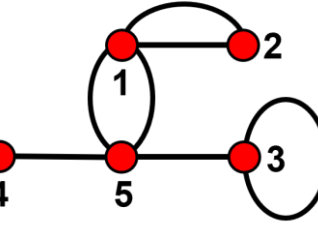
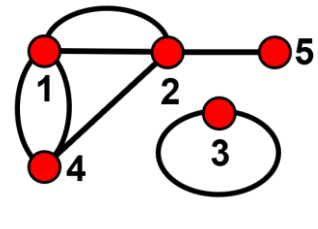
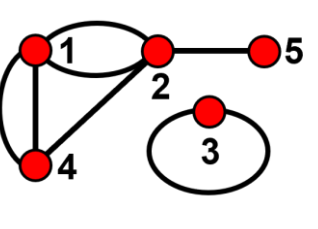
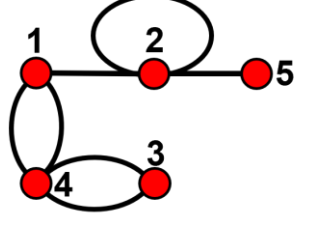
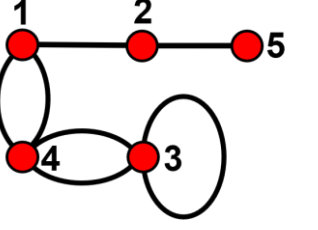
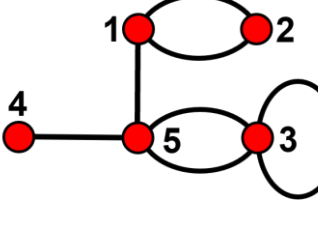
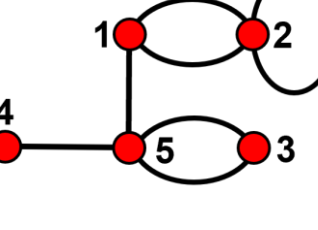
	<p>(4x1, 1x2, 2x2¹, 2x2²) a</p> 	<p>(4x1, 1x2, 2x2¹, 2x2²) b</p> 	<p>(4x1, 1x2, 2x2¹, 2x2²) c</p> 	<p>(4x1, 1x2, 2x2¹, 2x2²) d</p> 
	<p>(4x1, 1x2, 2x2¹, 2x2²) e</p> 	<p>(4x1, 1x2, 2x2¹, 2x2²) f</p> 	<p>(4x1, 1x2, 2x2¹, 2x2²) g</p> 	<p>(4x1, 1x2, 2x2¹, 2x2²) h</p> 
	<p>(4x1, 1x2, 2x2¹, 2x2²) i</p> 	<p>(4x1, 1x2, 2x2¹, 2x2²) j</p> 	<p>(4x1, 1x2, 2x2¹, 2x2²) k</p> 	<p>(4x1, 1x2, 2x2¹, 2x2²) l</p> 
	<p>(4x1, 1x2, 4x2²) a</p> 	<p>(4x1, 1x2, 4x2²) b</p> 	<p>(4x1, 1x2, 4x2²) c</p> 	<p>(4x1, 1x2, 4x2²) d</p> 

	<p>$(4x1, 1x2, 4x2^2)$ e</p>	<p>$(4x1, 1x2, 4x2^2)$ f</p>	<p>$(2x1, 4x2, 2x2^1)$</p>	<p>$(2x1, 4x2, 2x2^2)$</p>
	<p>$(2x1, 2x2, 4x2^1)$ a</p>	<p>$(2x1, 2x2, 4x2^1)$ b</p>	<p>$(2x1, 2x2, 4x2^1)$ c</p>	<p>$(2x1, 2x2, 4x2^1)$ d</p>
	<p>$(2x1, 2x2, 2x2^1, 2x2^2)$ a</p>	<p>$(2x1, 2x2, 2x2^1, 2x2^2)$ b</p>	<p>$(2x1, 2x2, 2x2^1, 2x2^2)$ c</p>	<p>$(2x1, 2x2, 2x2^1, 2x2^2)$ d</p>

	<p>$(2x1, 2x2, 2x2^1, 2x2^2)$ e</p>	<p>$(2x1, 2x2, 2x2^1, 2x2^2)$ f</p>	<p>$(2x1, 2x2, 2x2^1, 2x2^2)$ g</p>	<p>$(2x1, 2x2, 2x2^1, 2x2^2)$ h</p>
	<p>$(2x1, 2x2, 4x2^2)$ a</p>	<p>$(2x1, 2x2, 4x2^2)$ b</p>	<p>$(2x1, 2x2, 4x2^2)$ c</p>	<p>$(2x1, 2x2, 4x2^2)$ d</p>
	<p>$(2x1, 6x2^1)$</p>	<p>$(2x1, 4x2^1, 2x2^2)$ a</p>	<p>$(2x1, 4x2^1, 2x2^2)$ b</p>	<p>$(2x1, 4x2^1, 2x2^2)$ c</p>

	(2x1, 2x2 ¹ , 4x2 ²) a 	(2x1, 2x2 ¹ , 4x2 ²) b 	(2x1, 2x2 ¹ , 4x2 ²) c 	(2x1, 6x2 ²)
${}^1V_1{}^2V_1{}^3V_1{}^4V_3$	NG			
${}^1V_1{}^2V_1{}^3V_1{}^4V_4$	NG			
${}^1V_1{}^2V_1{}^3V_1{}^4V_5$	NG			
${}^1V_1{}^2V_1{}^3V_3{}^4V_1$	NG			
${}^1V_1{}^2V_1{}^3V_3{}^4V_2$	NG			
${}^1V_1{}^2V_1{}^3V_3{}^4V_3$	NG			
${}^1V_1{}^2V_1{}^3V_5{}^4V_1$	NG			
${}^1V_1{}^2V_2{}^3V_1{}^4V_1$	(12x1) 	(10x1, 1x2) a 	(10x1, 1x2) b 	(10x1, 1x2) c

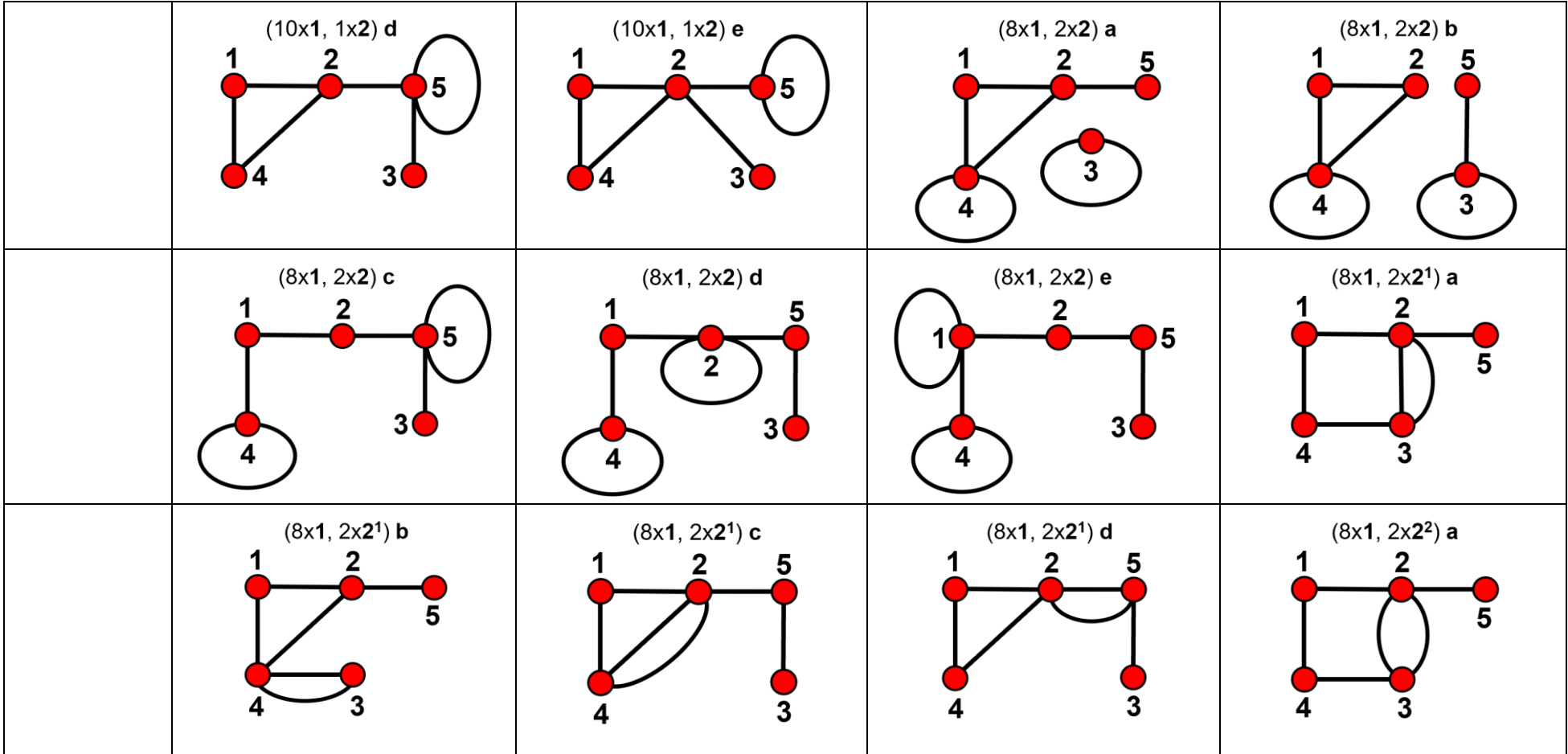

	<p>(8x1, 2x2²) b</p>	<p>(8x1, 2x2²) c</p>	<p>(8x1, 2x2²) d</p>	<p>(6x1, 3x2) a</p>
	<p>(6x1, 3x2) b</p>	<p>(6x1, 1x2, 2x2¹) a</p>	<p>(6x1, 1x2, 2x2¹) b</p>	<p>(6x1, 1x2, 2x2¹) c</p>
	<p>(6x1, 1x2, 2x2¹) d</p>	<p>(6x1, 1x2, 2x2¹) e</p>	<p>(6x1, 1x2, 2x2¹) f</p>	<p>(6x1, 1x2, 2x2²) a</p>
	<p>(6x1, 1x2, 2x2²) b</p>	<p>(6x1, 1x2, 2x2²) c</p>	<p>(6x1, 1x2, 2x2²) d</p>	<p>(6x1, 1x2, 2x2²) e</p>

	<p>(6x1, 1x2, 2x2²) f</p>	<p>(4x1, 4x2)</p>	<p>(4x1, 2x2, 2x2¹) a</p>	<p>(4x1, 2x2, 2x2¹) b</p>
	<p>(4x1, 2x2, 2x2¹) c</p>	<p>(4x1, 2x2, 2x2¹) d</p>	<p>(4x1, 2x2, 2x2¹) e</p>	<p>(4x1, 2x2, 2x2²) a</p>
	<p>(4x1, 2x2, 2x2²) b</p>	<p>(4x1, 2x2, 2x2²) c</p>	<p>(4x1, 2x2, 2x2²) d</p>	<p>(4x1, 2x2, 2x2²) e</p>
	<p>(4x1, 4x2¹) a</p>	<p>(4x1, 4x2¹) b</p>	<p>(4x1, 2x2¹, 2x2²) a</p>	<p>(4x1, 2x2¹, 2x2²) b</p>

	<p>($4x1, 2x2^1, 2x2^2$) c</p>	<p>($4x1, 2x2^1, 2x2^2$) d</p>	<p>($4x1, 4x2^2$) a</p>	<p>($4x1, 4x2^2$) b</p>
	<p>($2x1, 3x2, 2x2^1$) a</p>	<p>($2x1, 3x2, 2x2^1$) b</p>	<p>($2x1, 3x2, 2x2^2$) a</p>	<p>($2x1, 3x2, 2x2^2$) b</p>
	<p>($2x1, 1x2, 4x2^1$) a</p>	<p>($2x1, 1x2, 4x2^1$) b</p>	<p>($2x1, 1x2, 4x2^1$) c</p>	<p>($2x1, 1x2, 4x2^1$) d</p>
	<p>($2x1, 1x2, 2x2^1, 2x2^2$) a</p>	<p>($2x1, 1x2, 2x2^1, 2x2^2$) b</p>	<p>($2x1, 1x2, 2x2^1, 2x2^2$) c</p>	<p>($2x1, 1x2, 2x2^1, 2x2^2$) d</p>

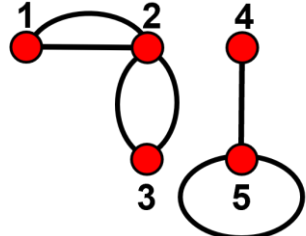
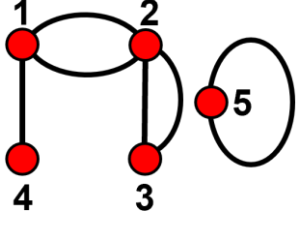
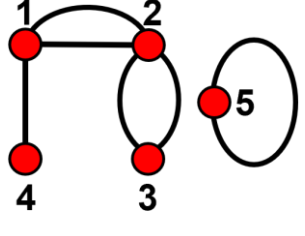
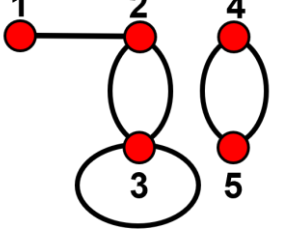
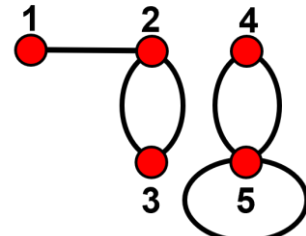
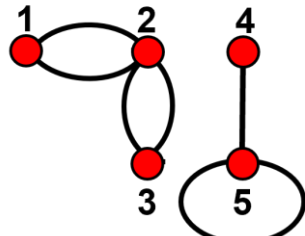
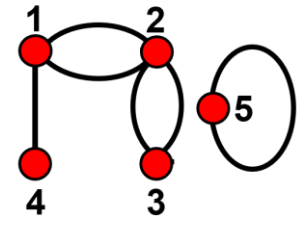
	(2x1, 1x2, 2x2 ¹ , 2x2 ²) e 	(2x1, 1x2, 2x2 ¹ , 2x2 ²) f 	(2x1, 1x2, 2x2 ¹ , 2x2 ²) g 	(2x1, 1x2, 4x2 ²) a 
	(2x1, 1x2, 4x2 ²) b 	(2x1, 1x2, 4x2 ²) c 	(2x1, 1x2, 4x2 ²) d 	
${}^1V_1{}^2V_2{}^3V_1{}^4V_2$	NG			
${}^1V_1{}^2V_2{}^3V_1{}^4V_3$	NG			
${}^1V_1{}^2V_2{}^3V_1{}^4V_4$	NG			
${}^1V_1{}^2V_2{}^3V_3{}^4V_1$	NG			
${}^1V_1{}^2V_2{}^3V_3{}^4V_2$	NG			
${}^1V_1{}^2V_3{}^3V_1{}^4V_1$	NG			
${}^1V_1{}^2V_3{}^3V_1{}^4V_2$	NG			
${}^1V_1{}^2V_3{}^3V_1{}^4V_3$	NG			
${}^1V_1{}^2V_3{}^3V_3{}^4V_1$	NG			
${}^1V_1{}^2V_4{}^3V_1{}^4V_1$	NG			
${}^1V_1{}^2V_4{}^3V_1{}^4V_2$	NG			

${}^1V_1^2V_5^3V_1^4V_1$	NG			
${}^1V_2^2V_1^3V_2^4V_1$	NG			
${}^1V_2^2V_1^3V_2^4V_2$	NG			
${}^1V_2^2V_1^3V_2^4V_3$	NG			
${}^1V_2^2V_1^3V_4^4V_1$	NG			
${}^1V_2^2V_2^3V_2^4V_1$	NG			
${}^1V_2^2V_2^3V_2^4V_2$	NG			
${}^1V_2^2V_3^3V_2^4V_1$	NG			
${}^1V_3^2V_1^3V_1^4V_1$	NG			
${}^1V_3^2V_1^3V_1^4V_2$	NG			
${}^1V_3^2V_1^3V_1^4V_3$	NG			
${}^1V_3^2V_1^3V_3^4V_1$	NG			
${}^1V_3^2V_2^3V_1^4V_1$	NG			
${}^1V_3^2V_2^3V_1^4V_2$	NG			
${}^1V_3^2V_3^3V_1^4V_1$	NG			
${}^1V_4^2V_1^3V_2^4V_1$	NG			
${}^1V_5^2V_1^3V_1^4V_1$	NG			

Vertex connectivities (cV_i) where e_A is odd cannot form graphs and are not listed.

NG = chain graphs not generated.