

Stereographic symmetry and general position diagrams of the representative groups of the 343 types of spatio-temporal crystallographic point groups with time translations and time inversion

This document contains stereographic projections that show symmetry elements and general positions for all 343 listed space-time groups. A separate diagram for the elements and positions are drawn on each page. They are labeled below with the serial number of the group they are associated with that is assigned in the main listing.

Anticlockwise is defined as the positive direction for axial rotations in all diagrams. For groups with three-fold and six-fold axial symmetry, the $[100]$ axis makes an angle of $-\pi/6$ with the in-plane horizontal direction. For all other groups, the $[100]$ axis is taken to be in the in-plane horizontal direction. The $[001]$ axis is taken to be in the out-of-plane direction for all groups.

Time reversal is indicated in the element and position diagrams through a red coloring of the element symbol and position marker respectively. Time translation is indicated by a blue fraction on all diagrams, with a “+” or “-” superscript on the position diagrams to indicate whether it is associated with the point above or below the plane. It should be noted that only right-handed rotations and their associated time translations are shown on the element diagrams. For symbols in the center of the diagram, time translations are plotted above the element diagram next to the symbol to avoid clutter. Furthermore, for groups where there is an equivalent element with time reversal for every operation (gray groups), element symbols are colored with both black and red.

We would like to thank Jeremy Karl Cockcroft for giving permission to modify and use the stereographic projections from his online course on powder diffraction (Attfield 1997).

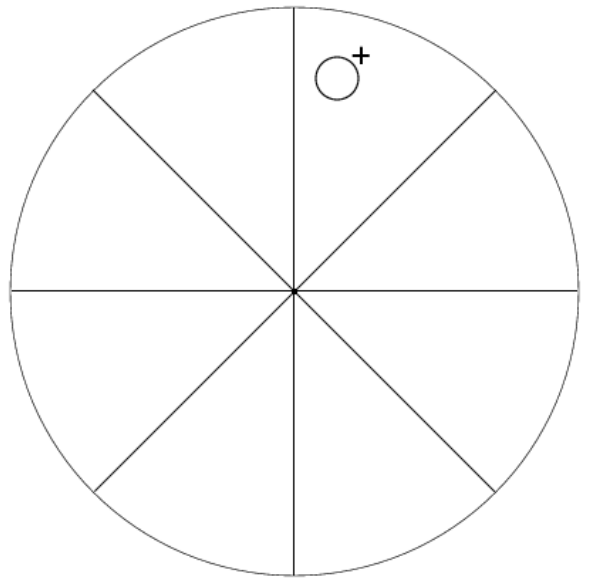
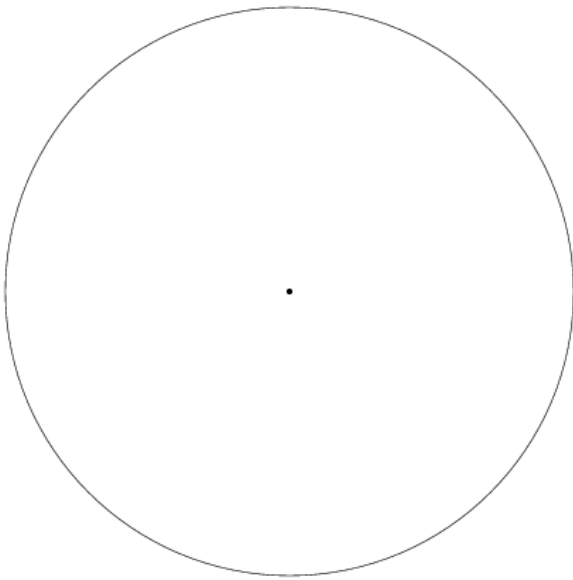

1.1.1.1

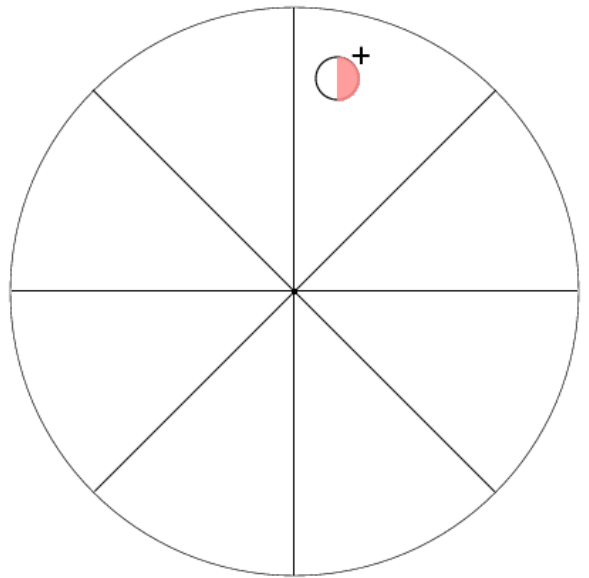
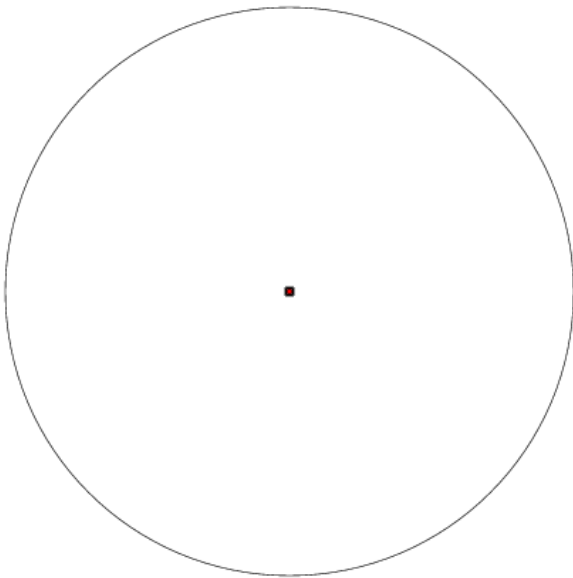

1.1.2.2

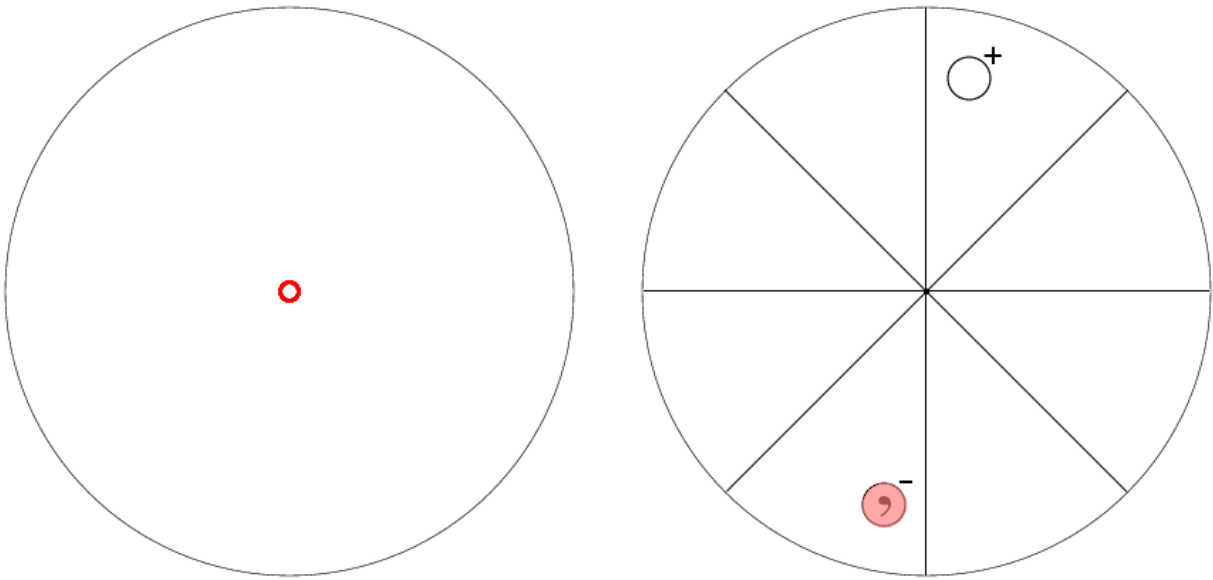

1.1.3.3

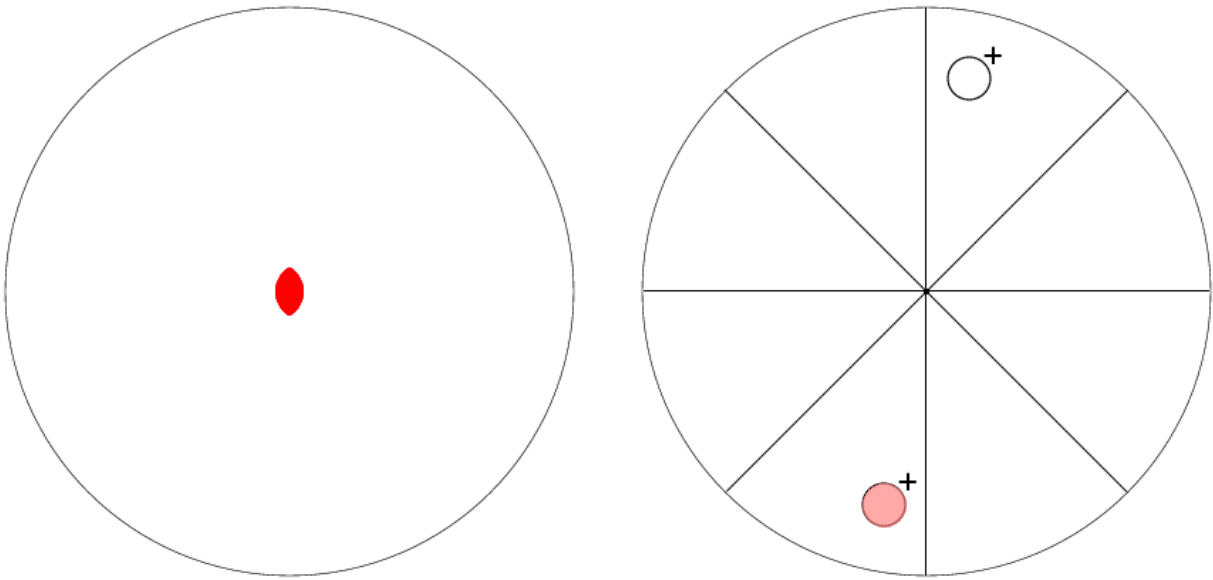

1.1.4.4

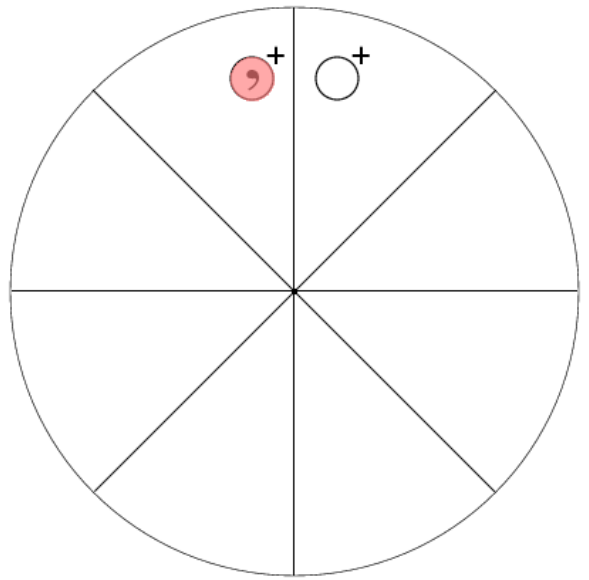
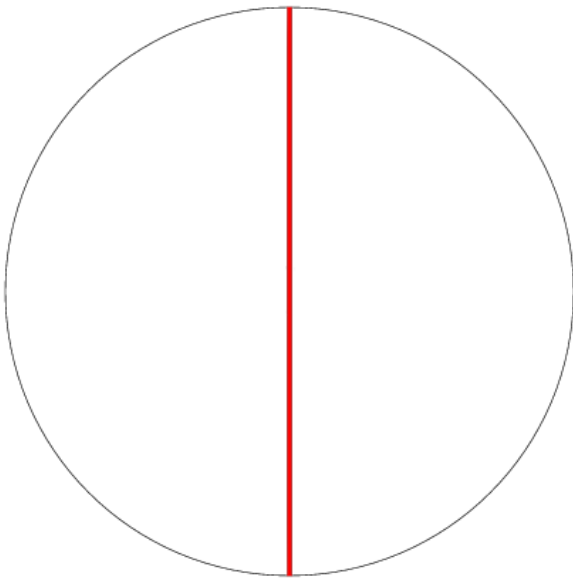

1.1.5.5

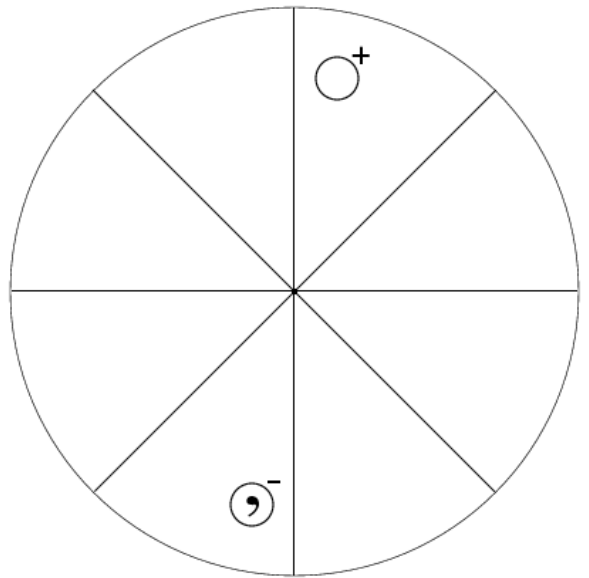
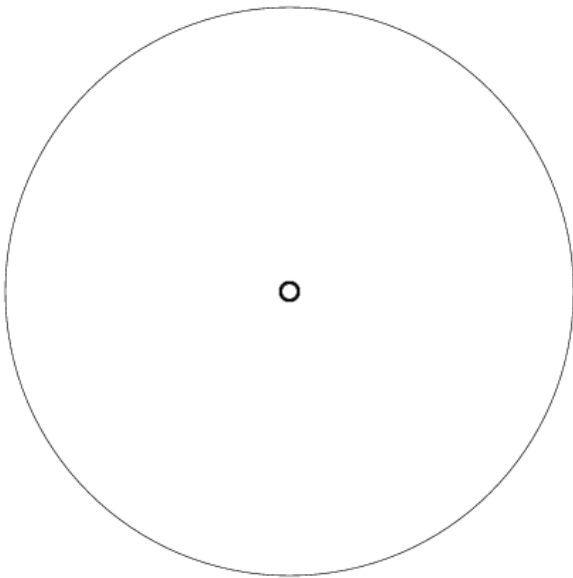

2.1.1.6

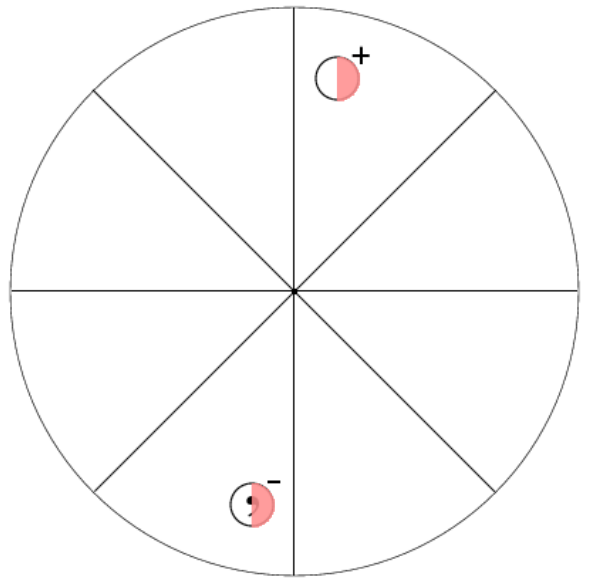
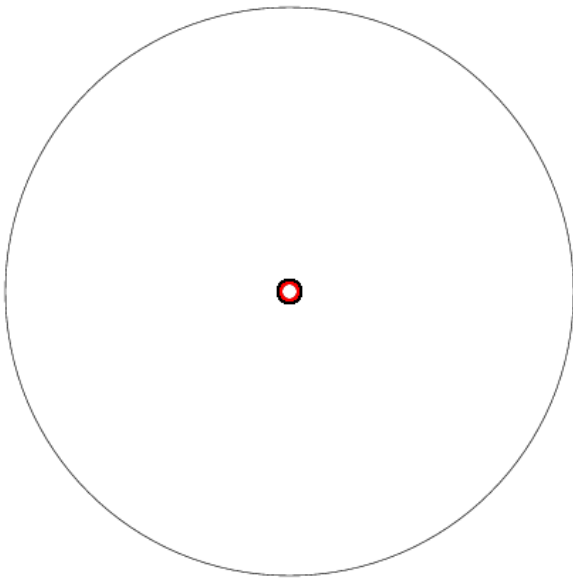

2.1.2.7

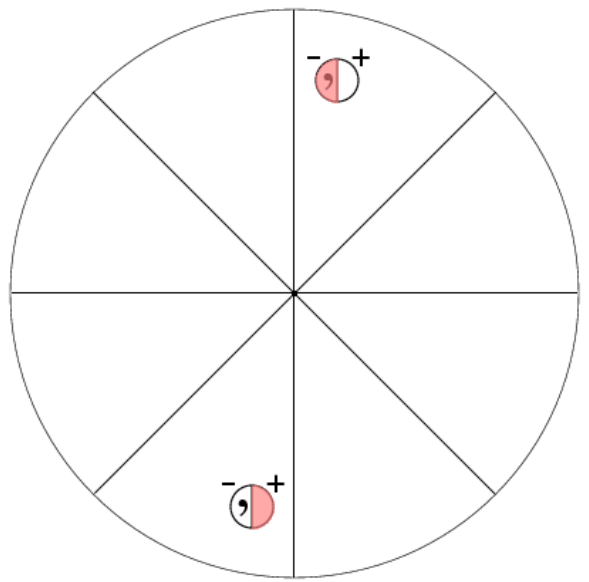
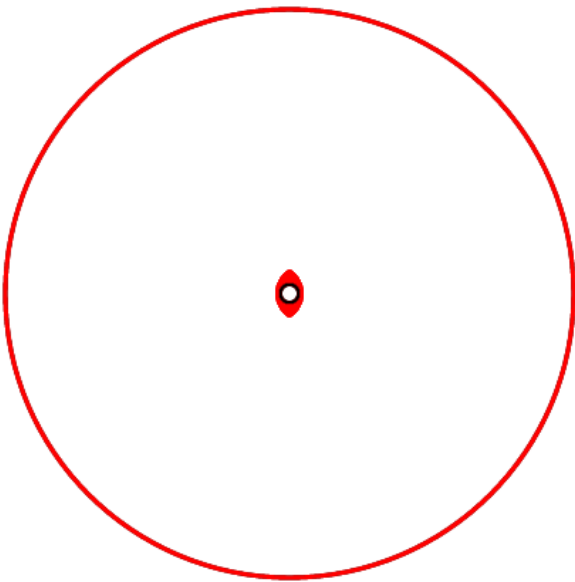

2.1.3.8

$\circ \frac{1}{2}$

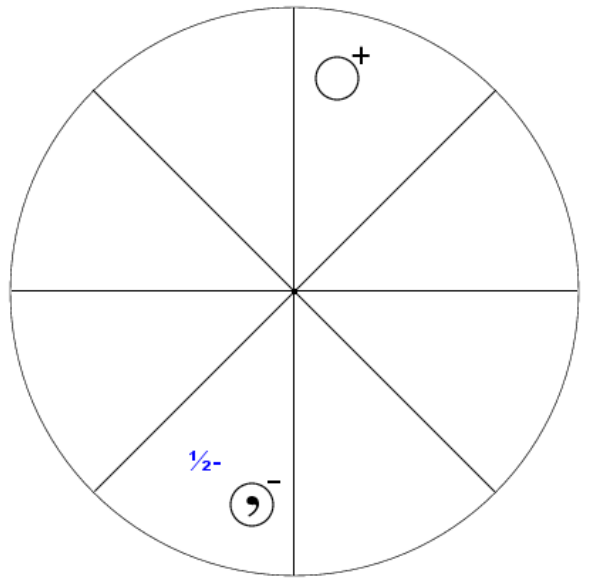
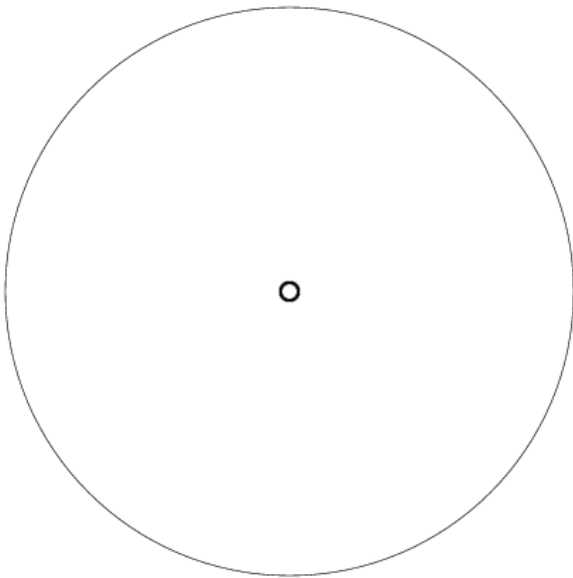

2.2.1.9

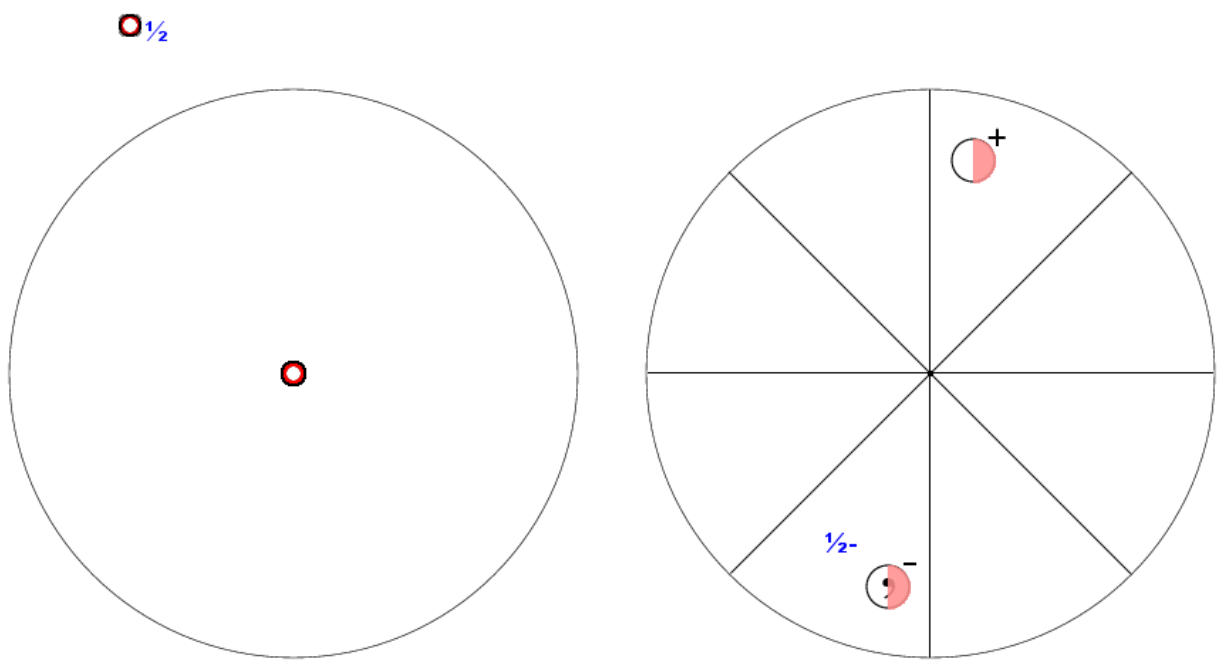

2.2.2.10

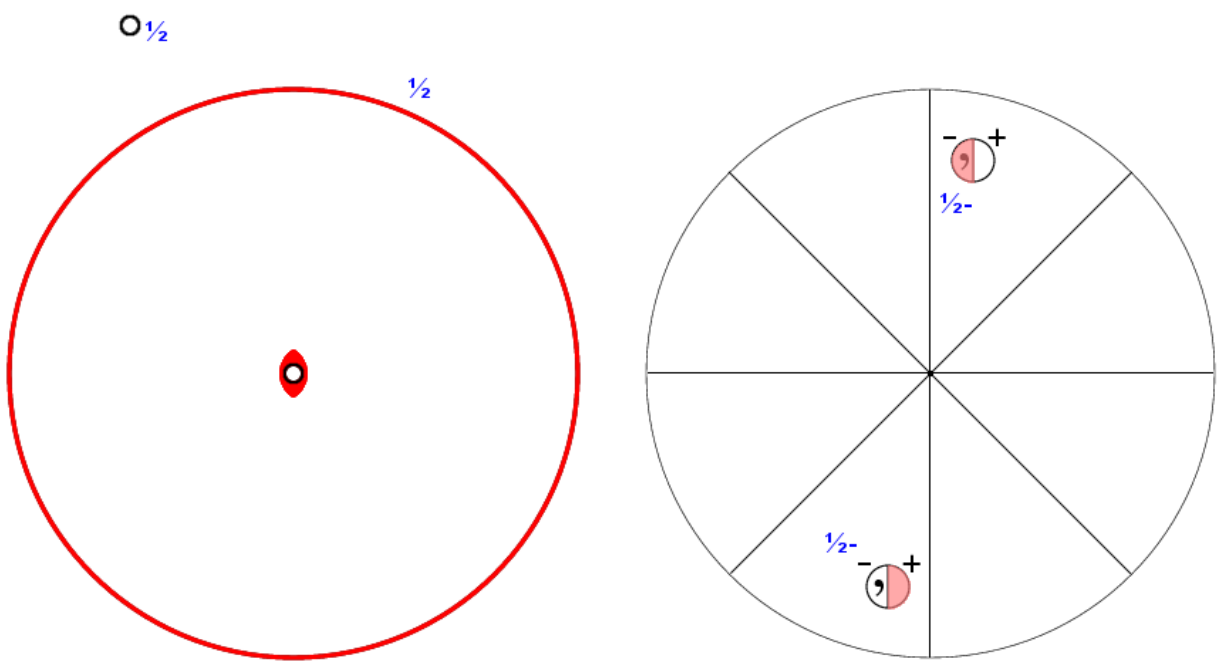

2.2.3.11

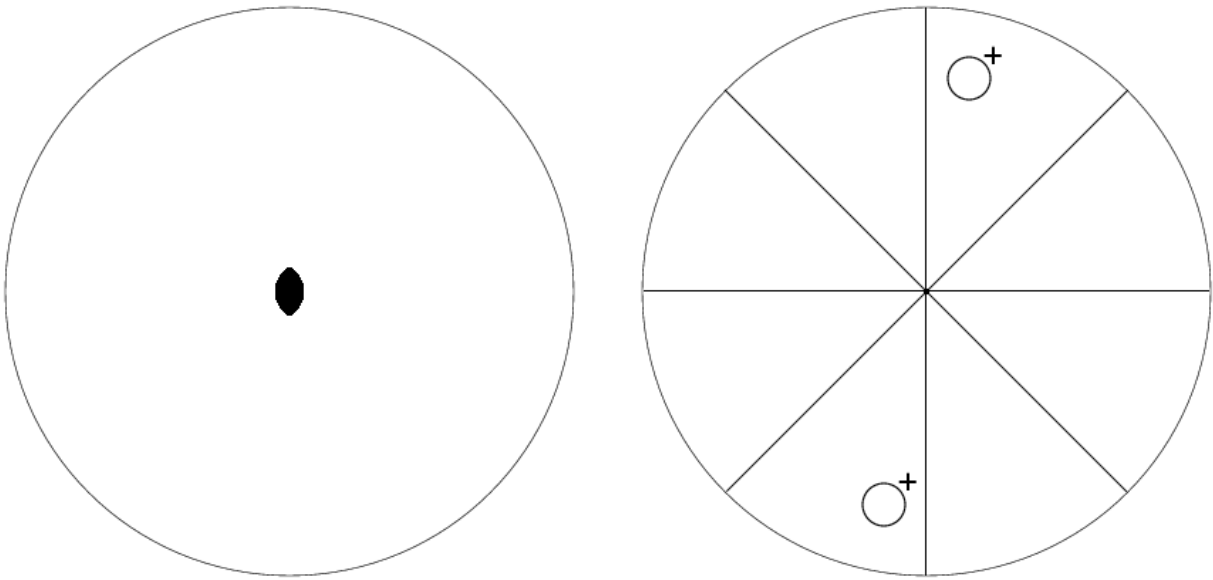

3.1.1.12

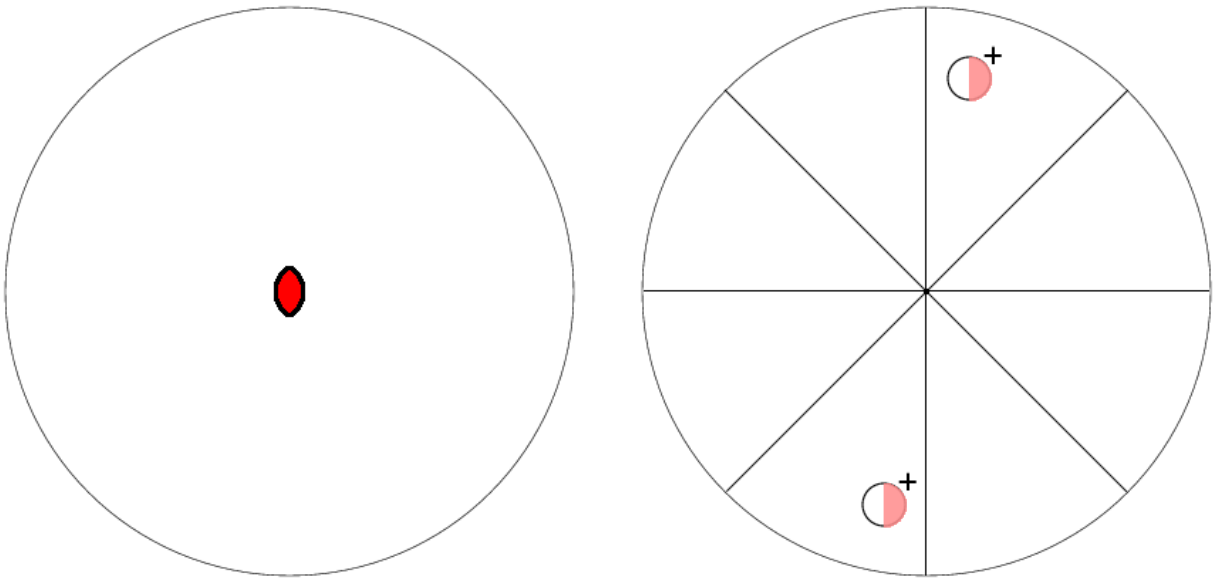

3.1.2.13

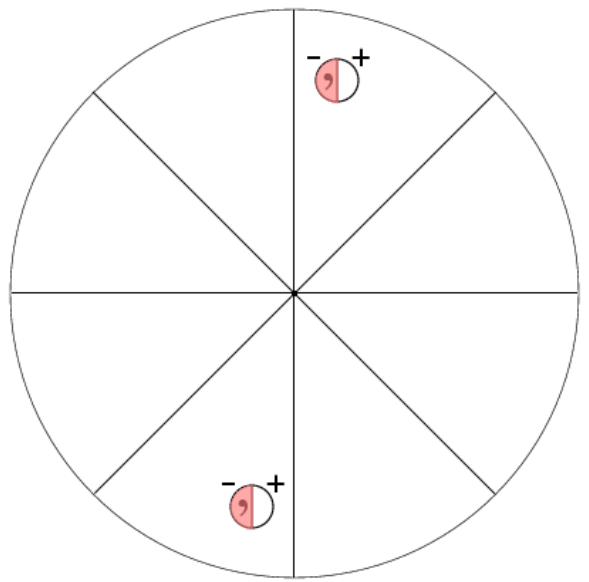
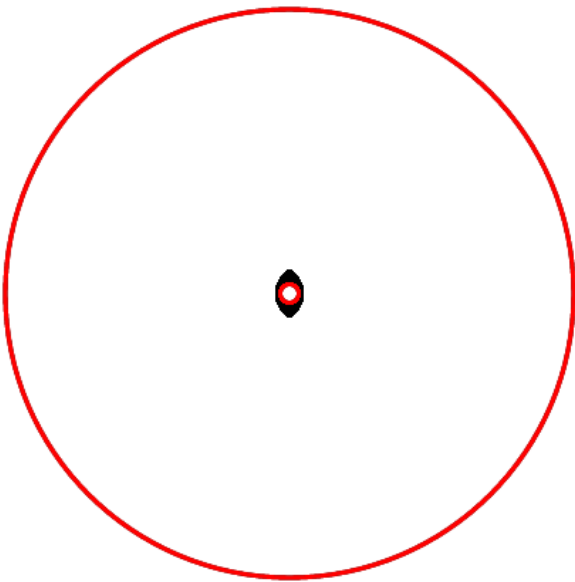

3.1.3.14

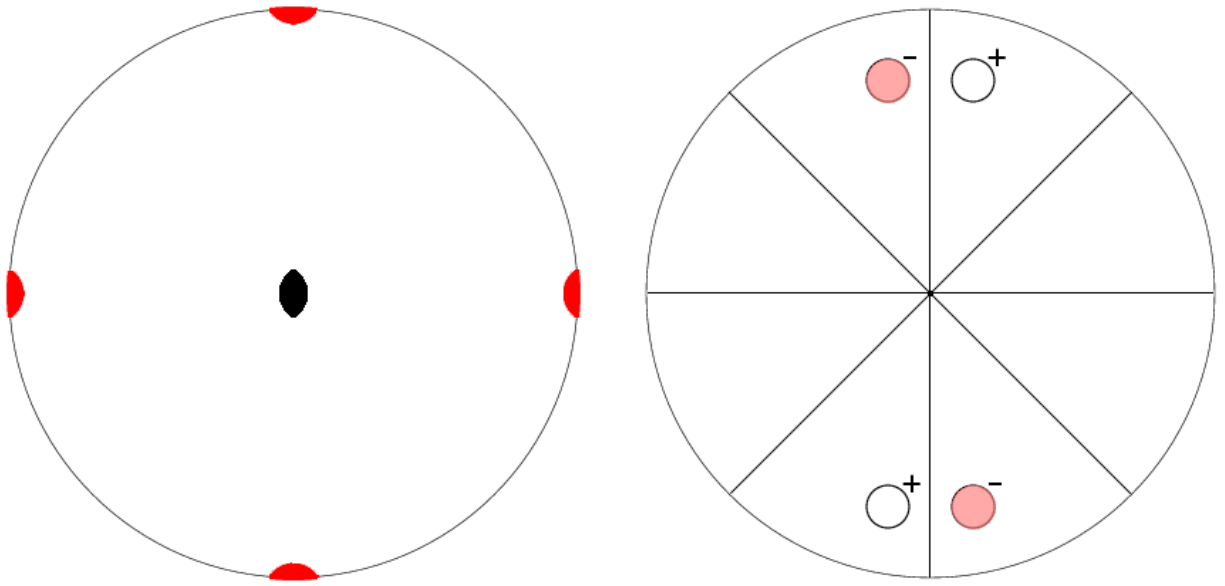

3.1.4.15

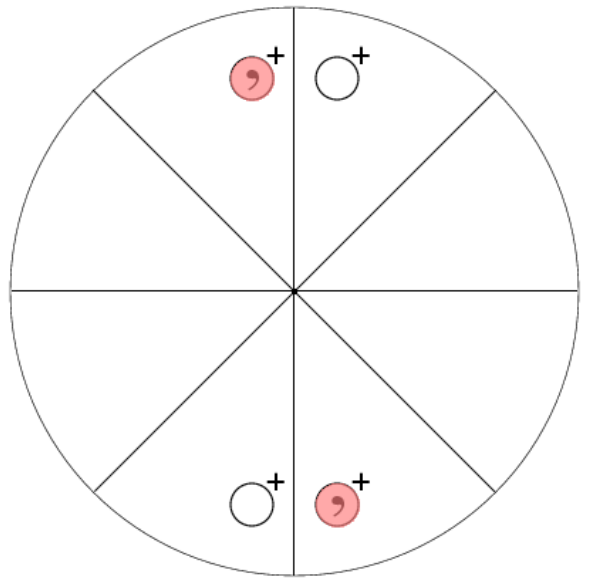
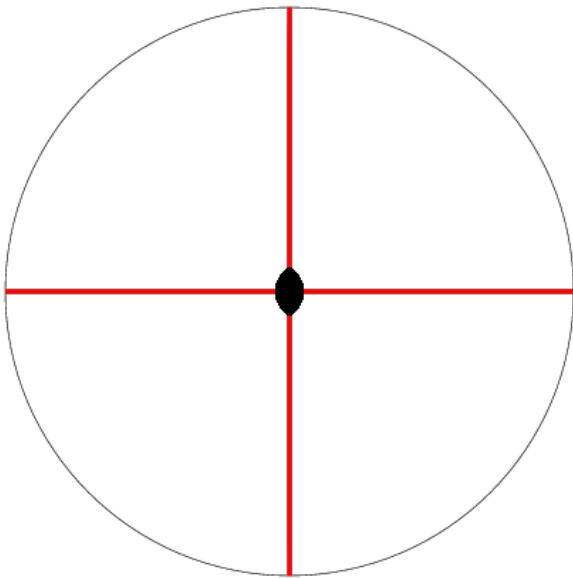

3.1.5.16

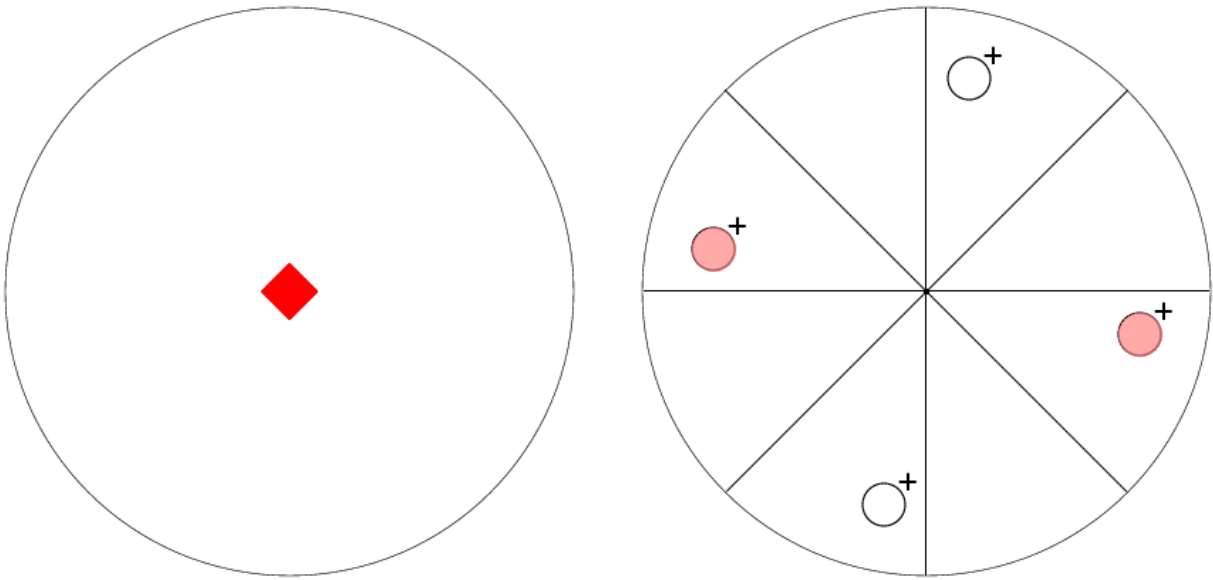

3.1.6.17

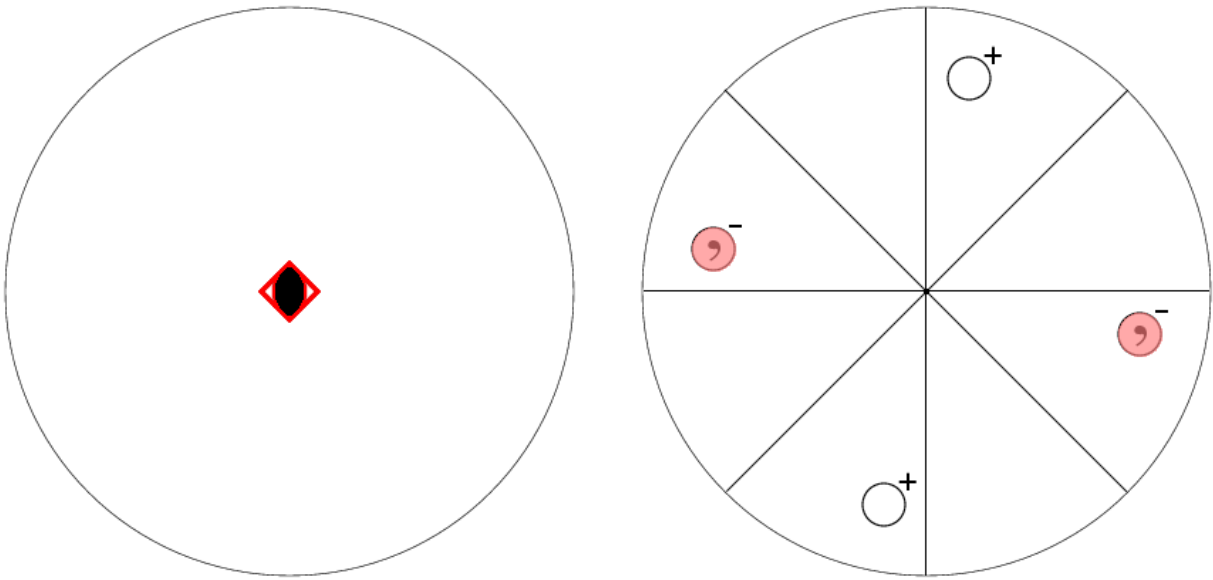

3.1.7.18

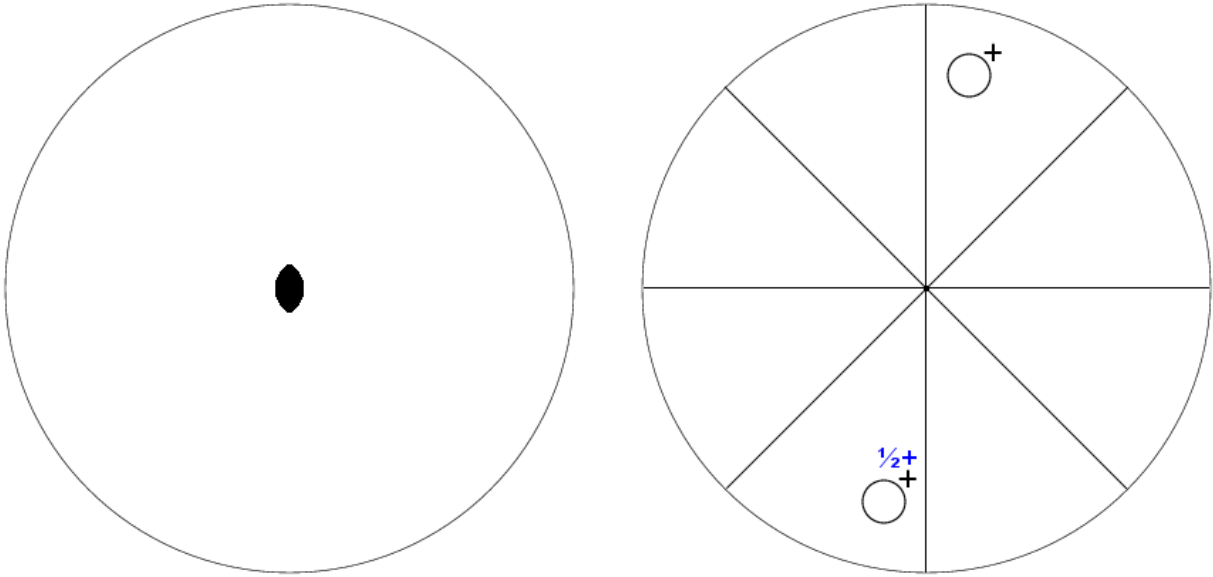

3.2.1.19

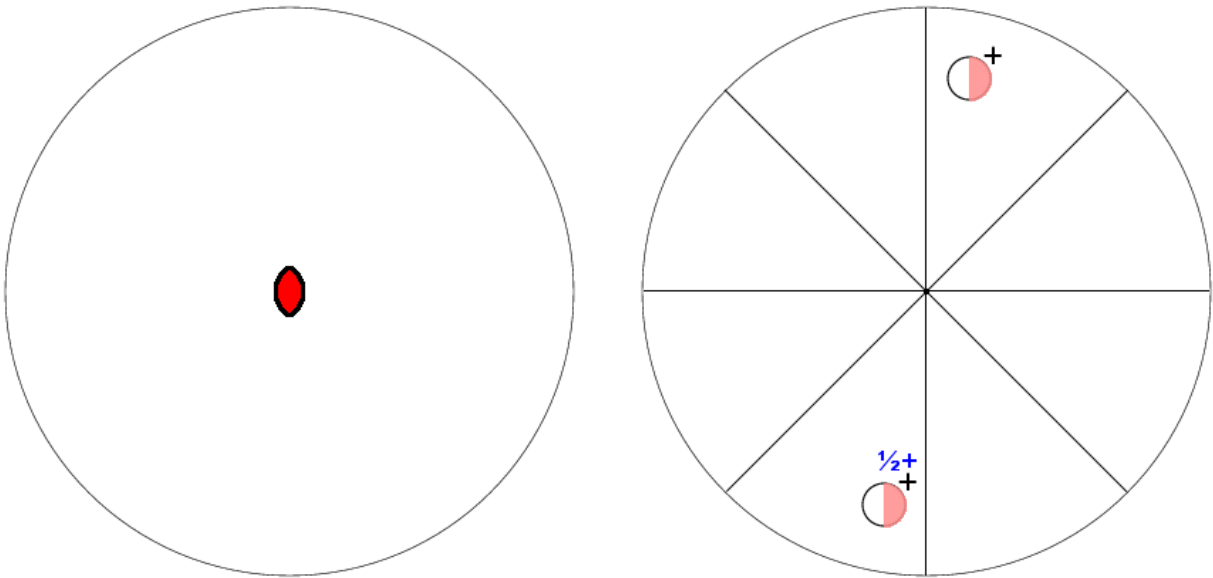

3.2.2.20

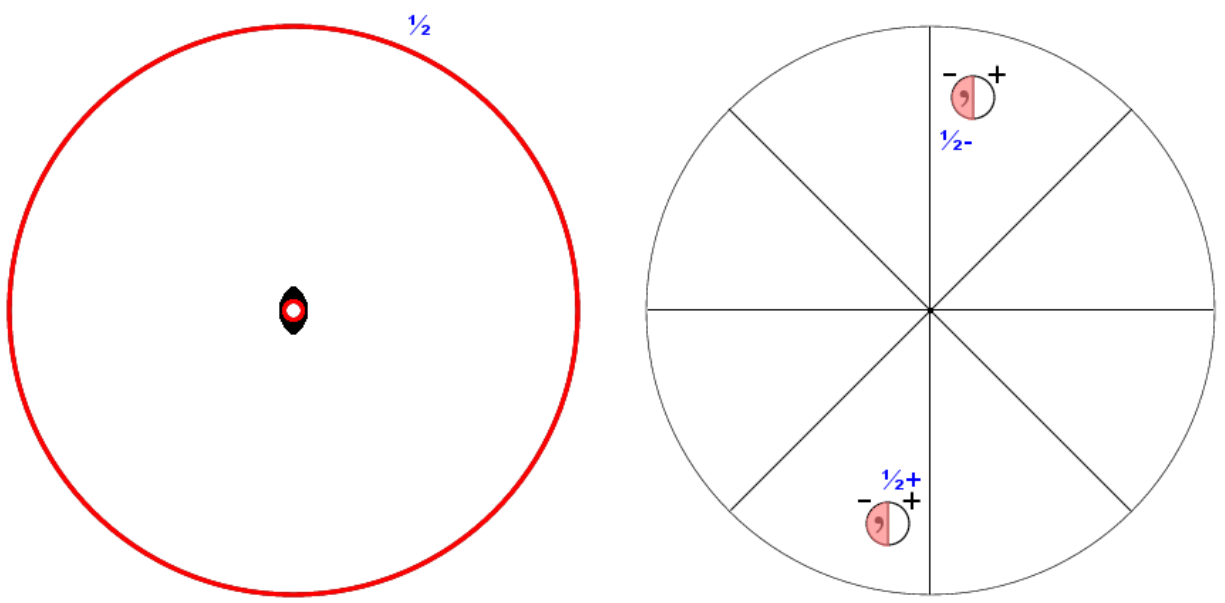

3.2.3.21

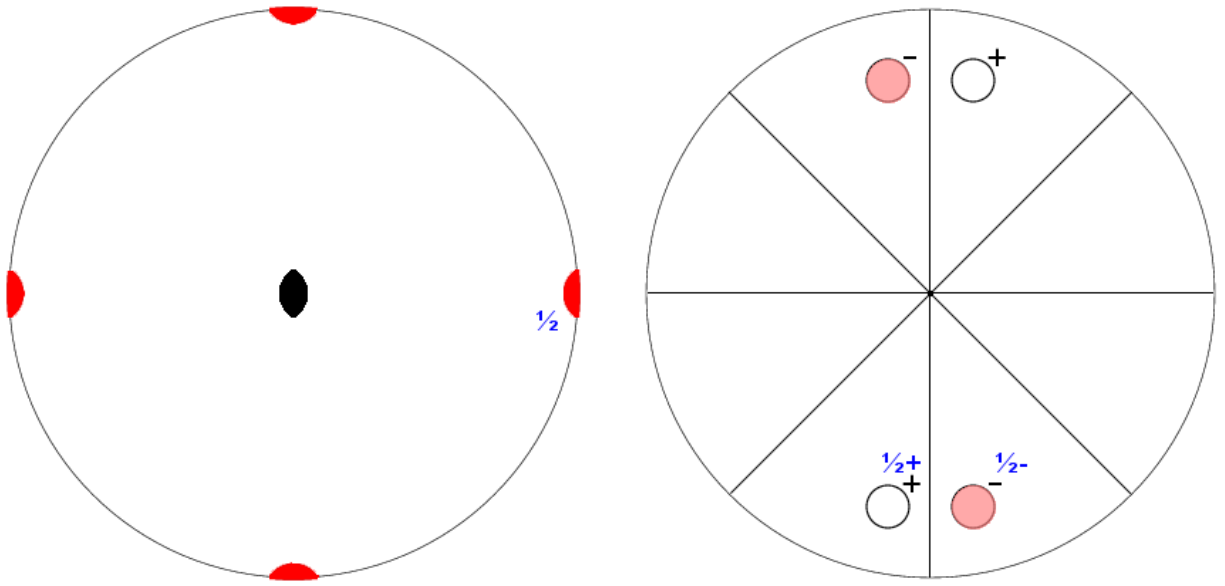

3.2.4.22

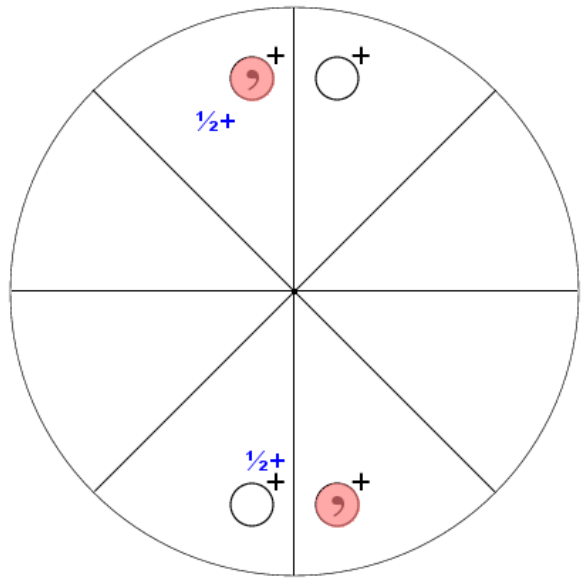
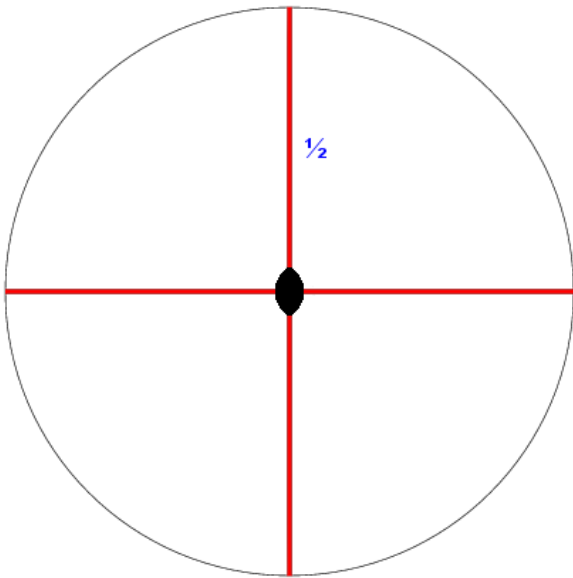

3.2.5.23

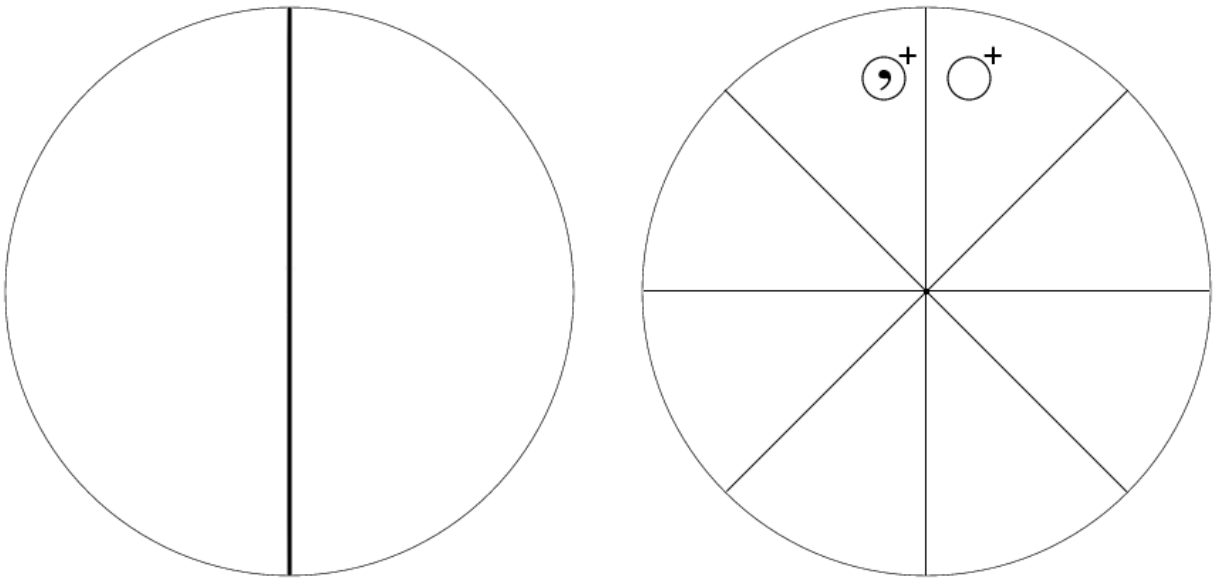

4.1.1.24

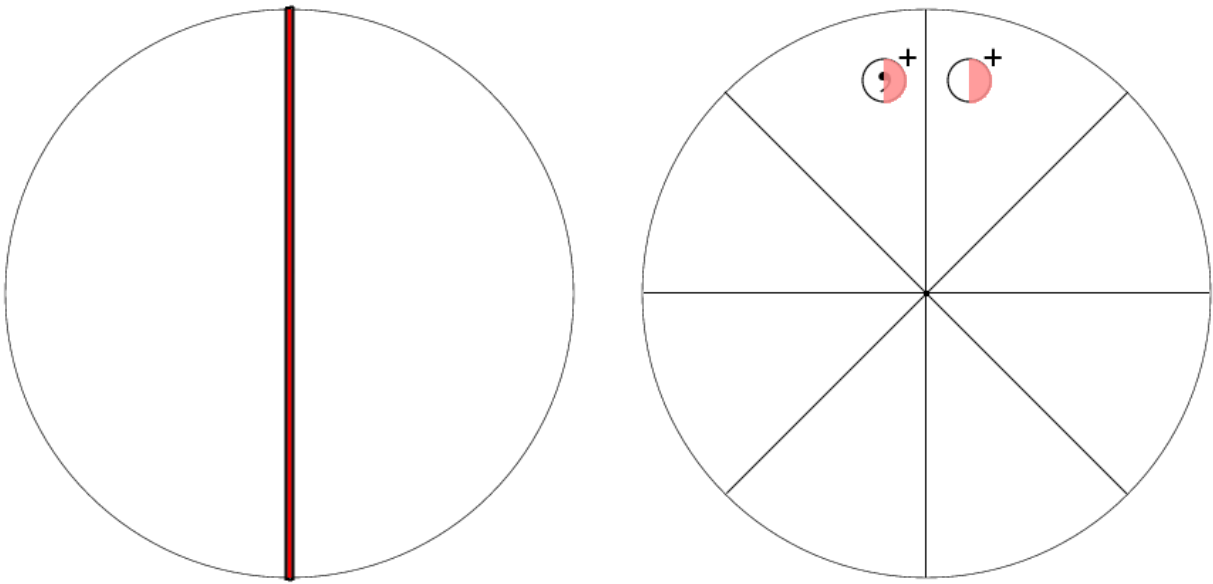

4.1.2.25

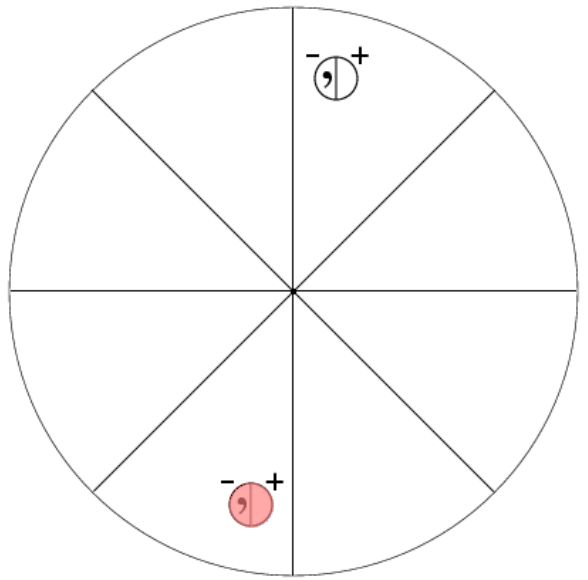
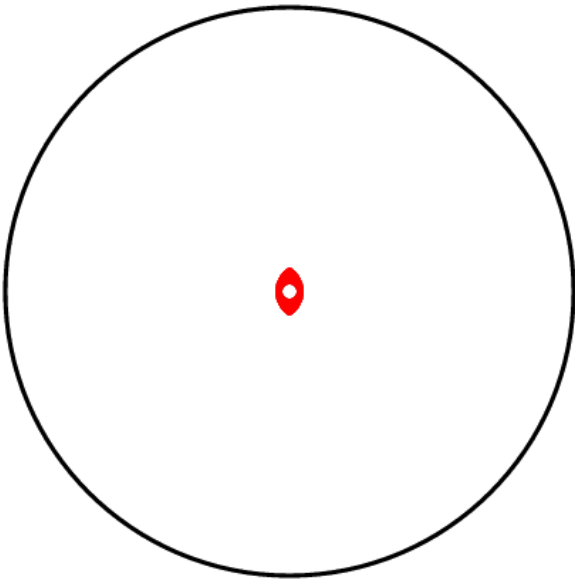

4.1.3.26

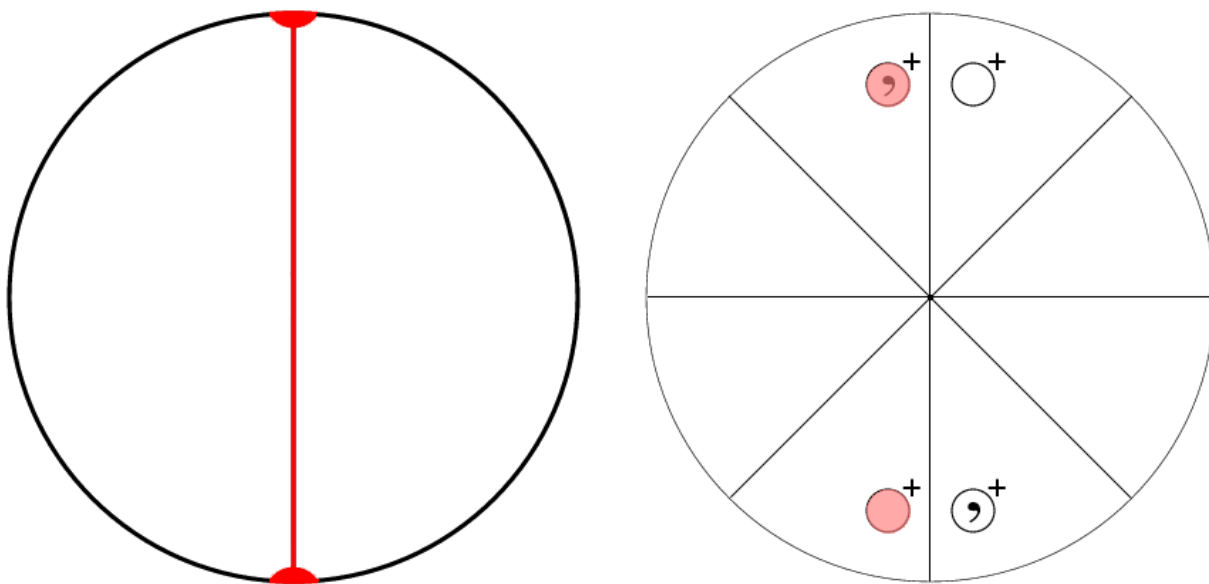

4.1.4.27

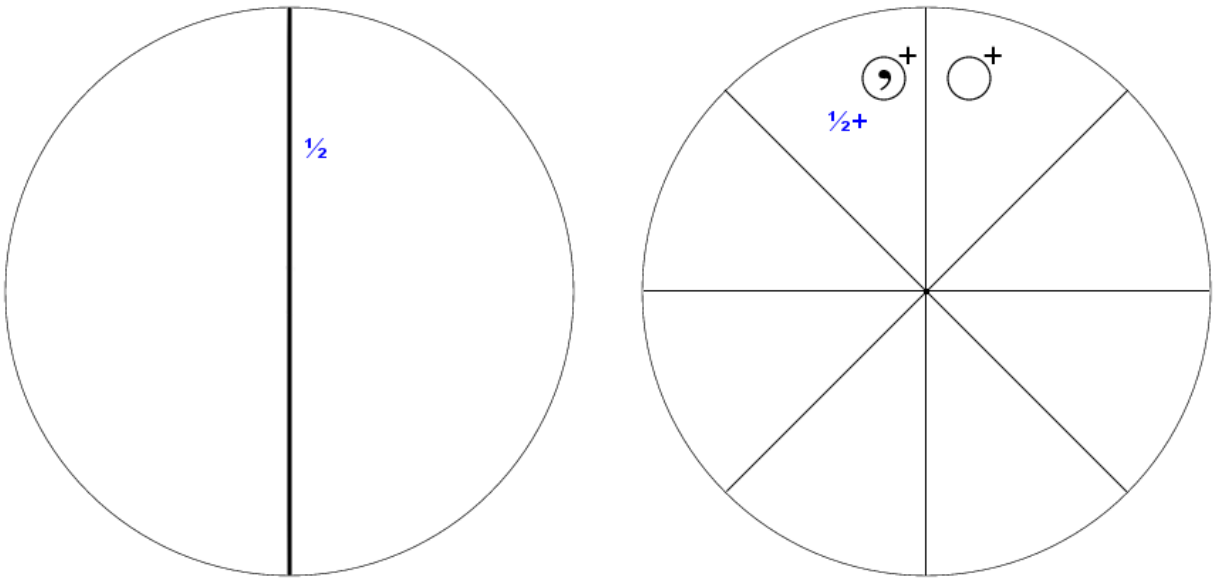

4.2.1.28

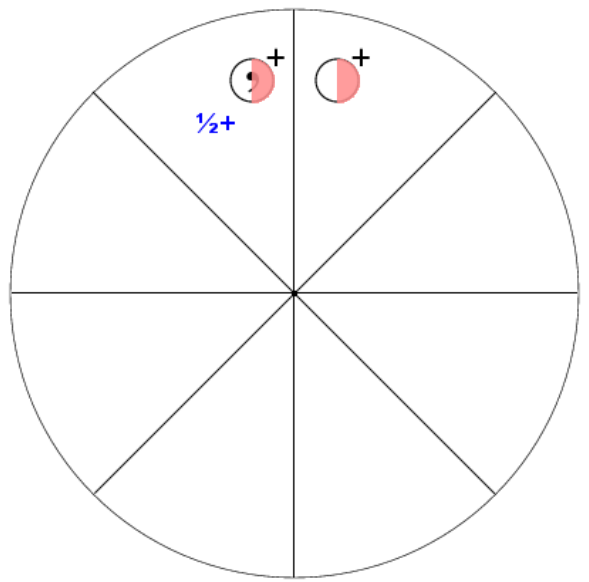
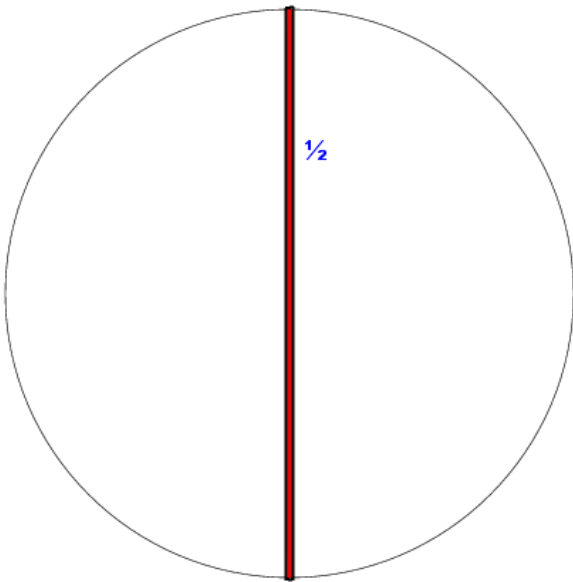

4.2.2.29

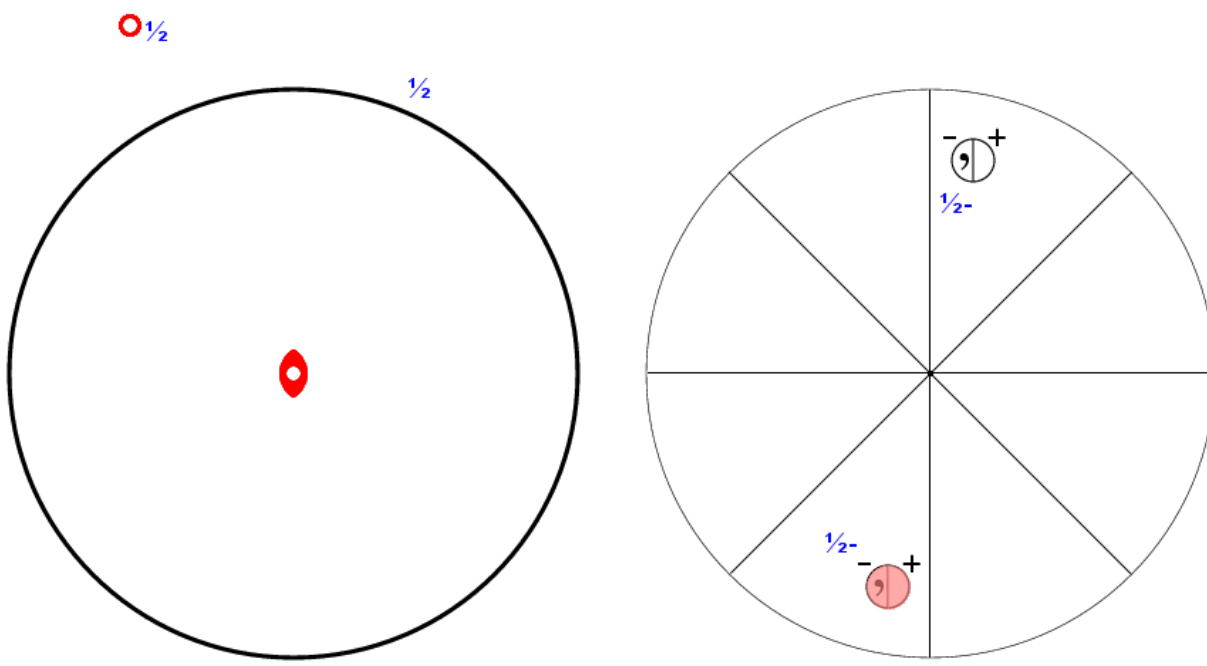

4.2.3.30

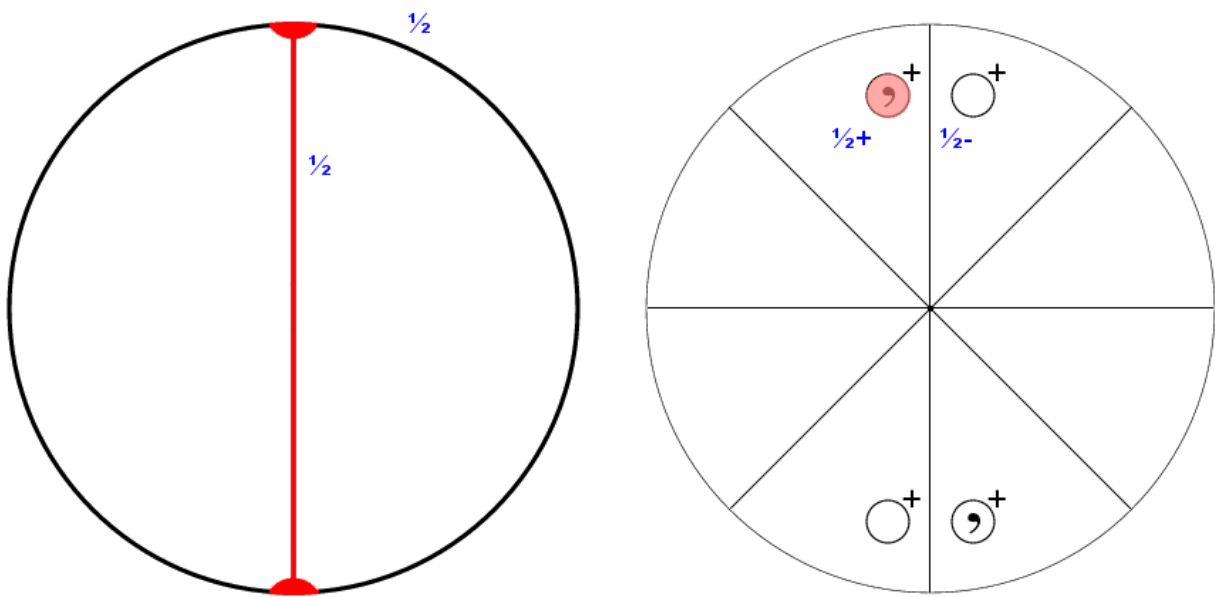

4.2.4.31

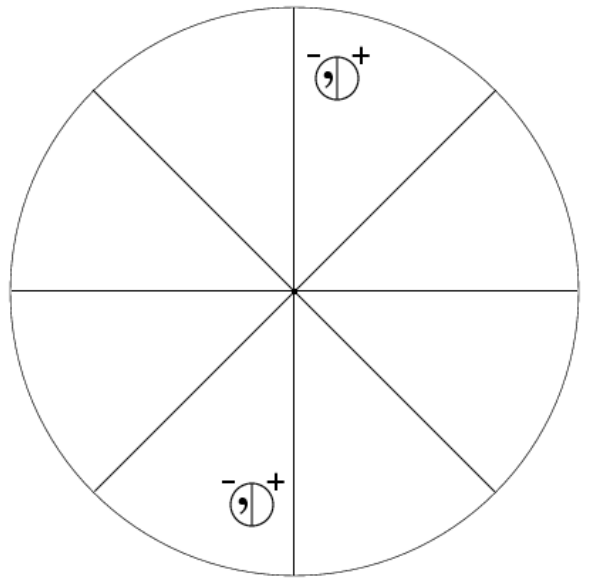
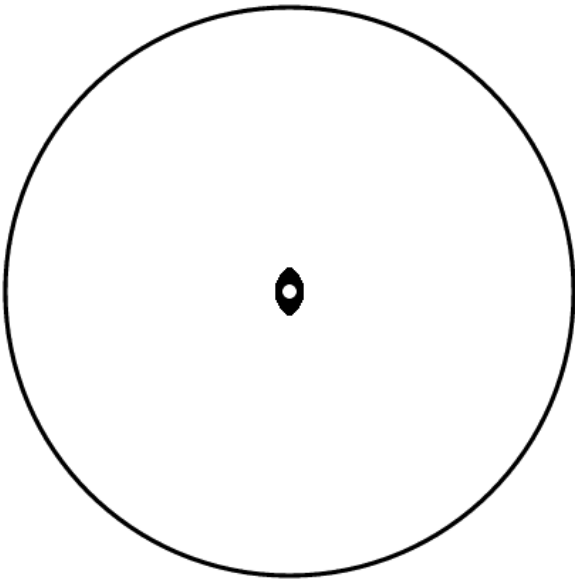

5.1.1.32

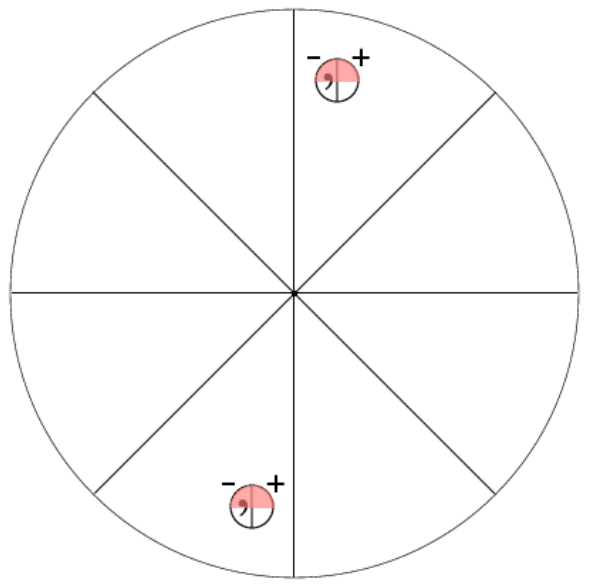
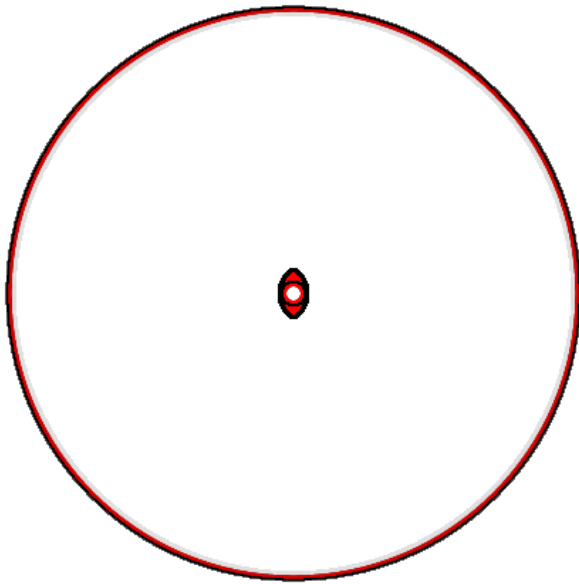

5.1.2.33

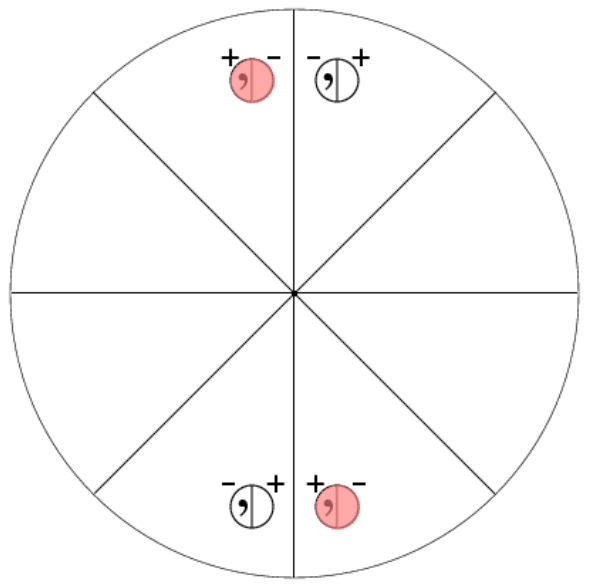
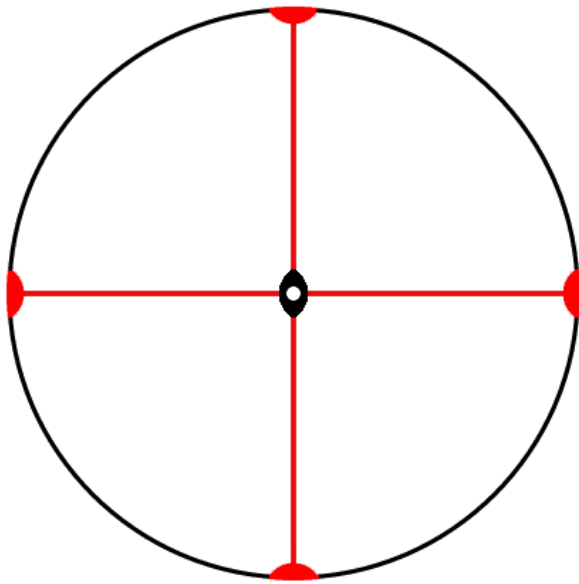

5.1.3.34

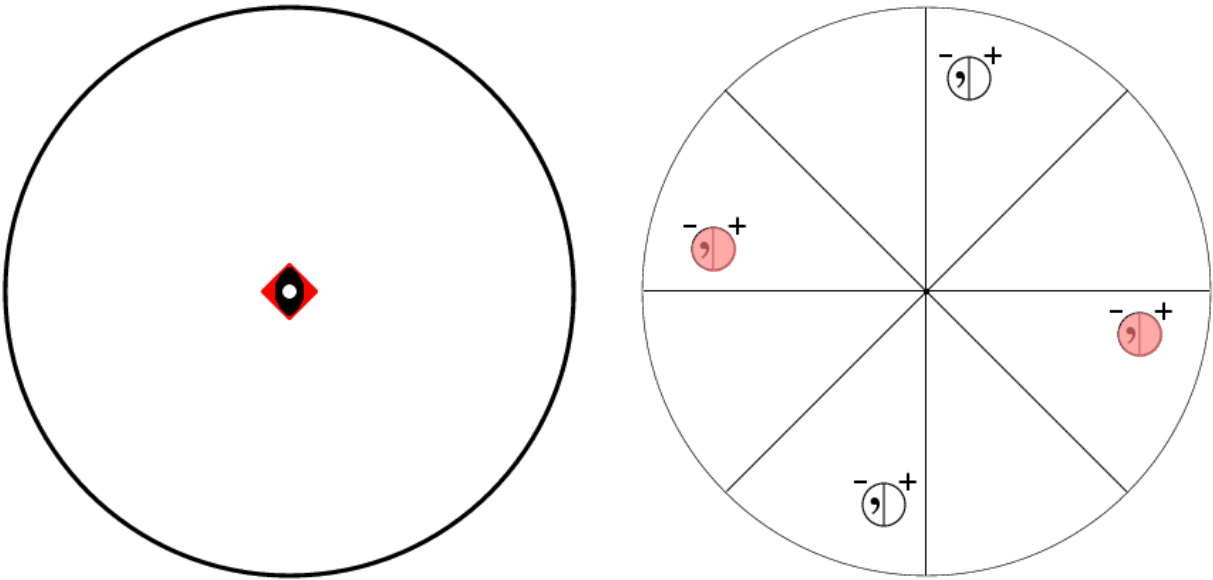

5.1.4.35

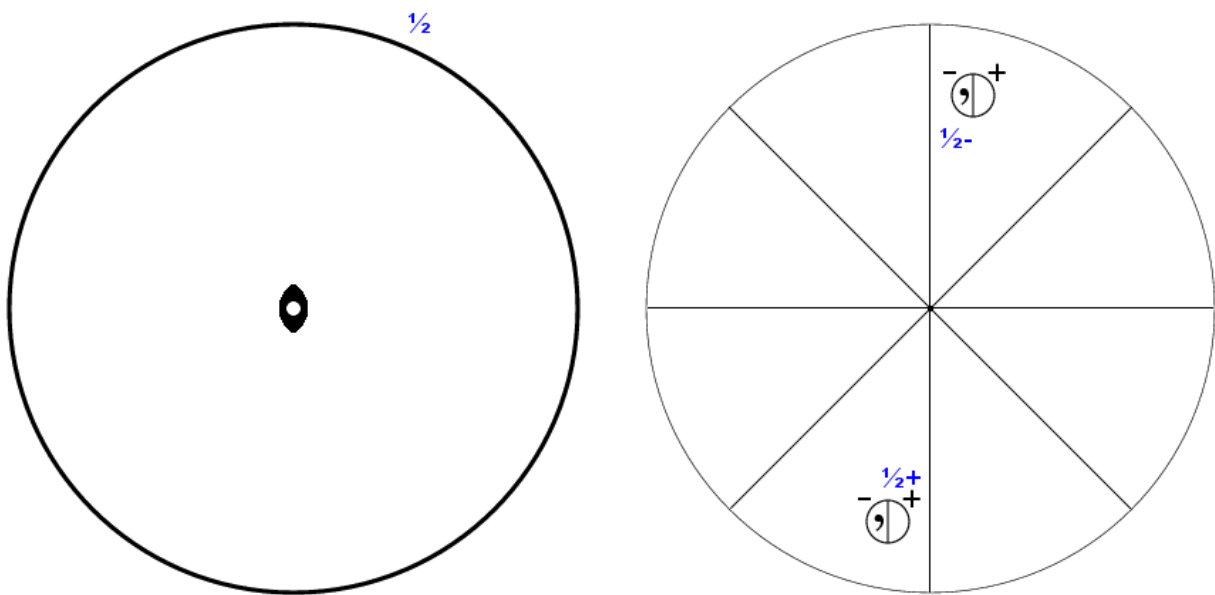

5.2.1.36

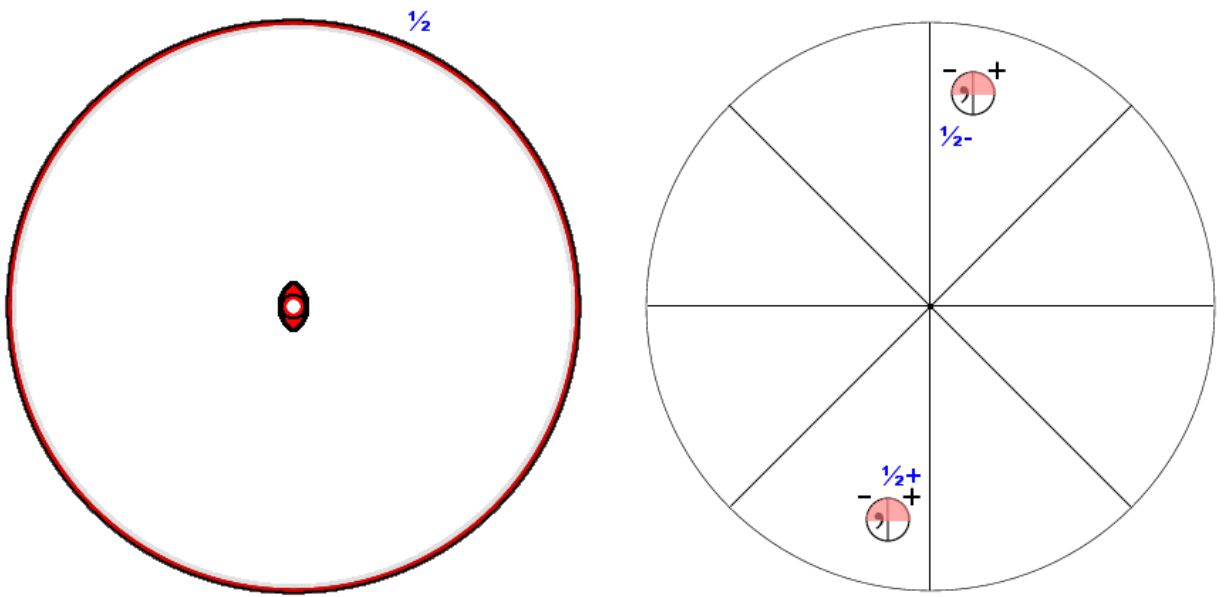

5.2.2.37

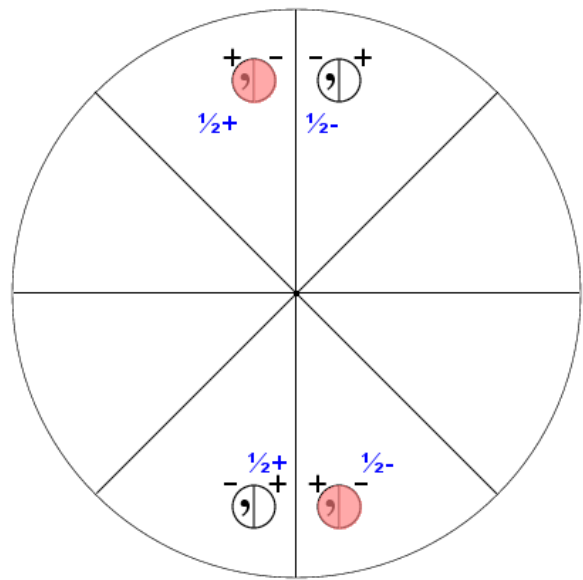
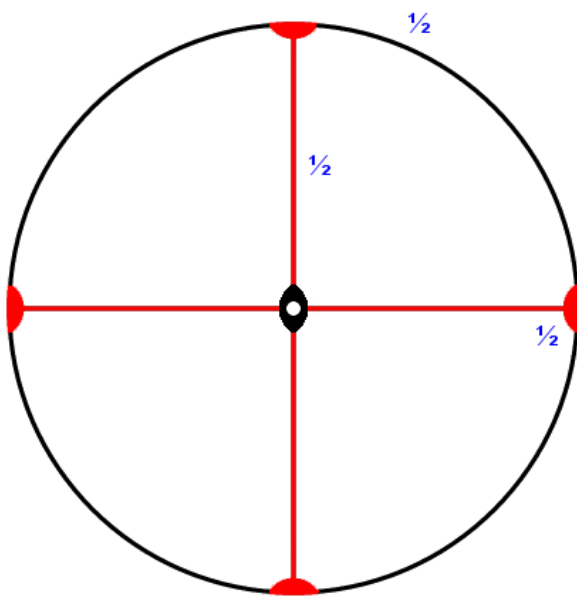

5.2.3.38

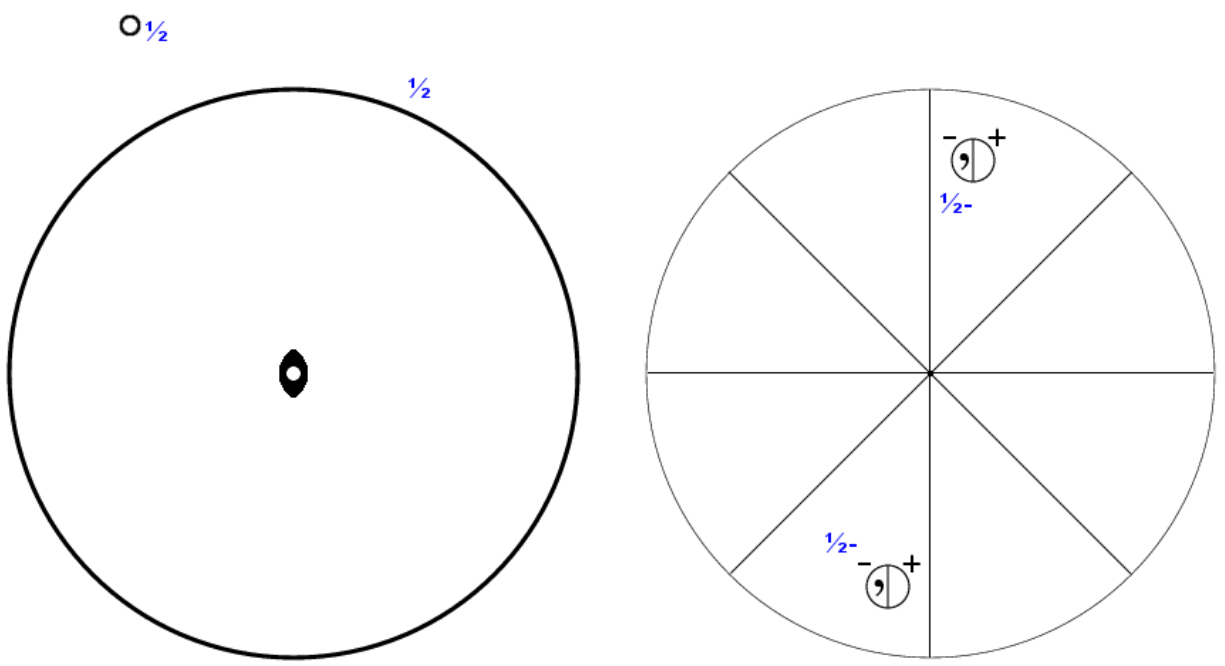

5.3.1.39

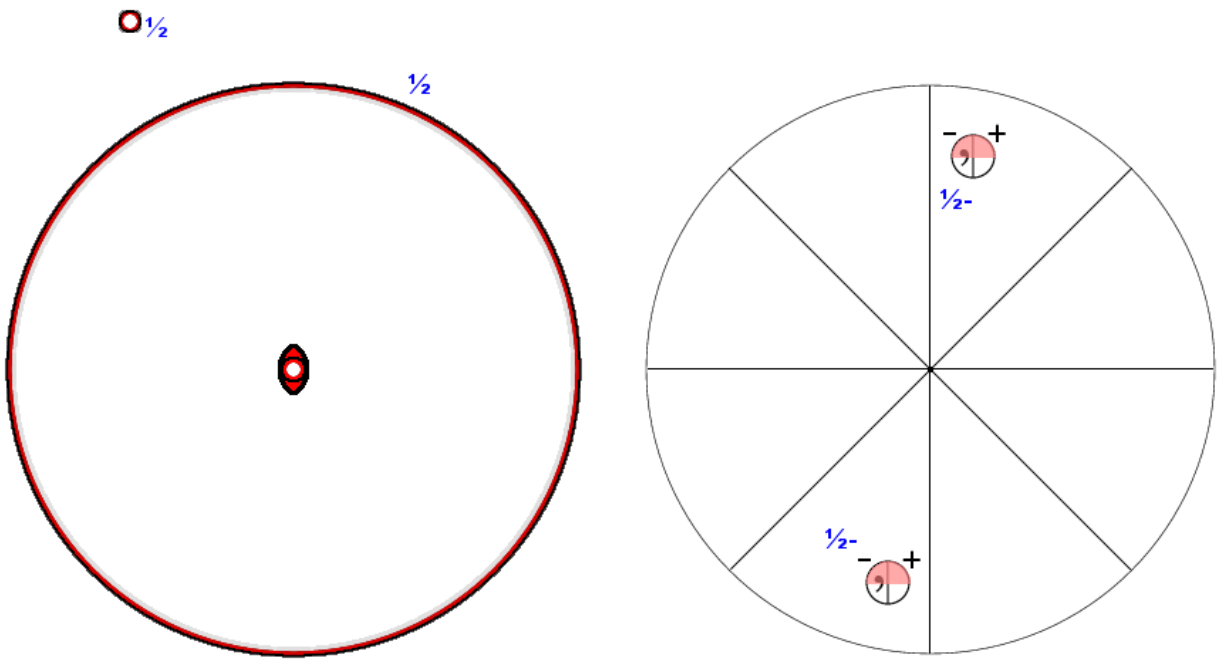

5.3.2.40

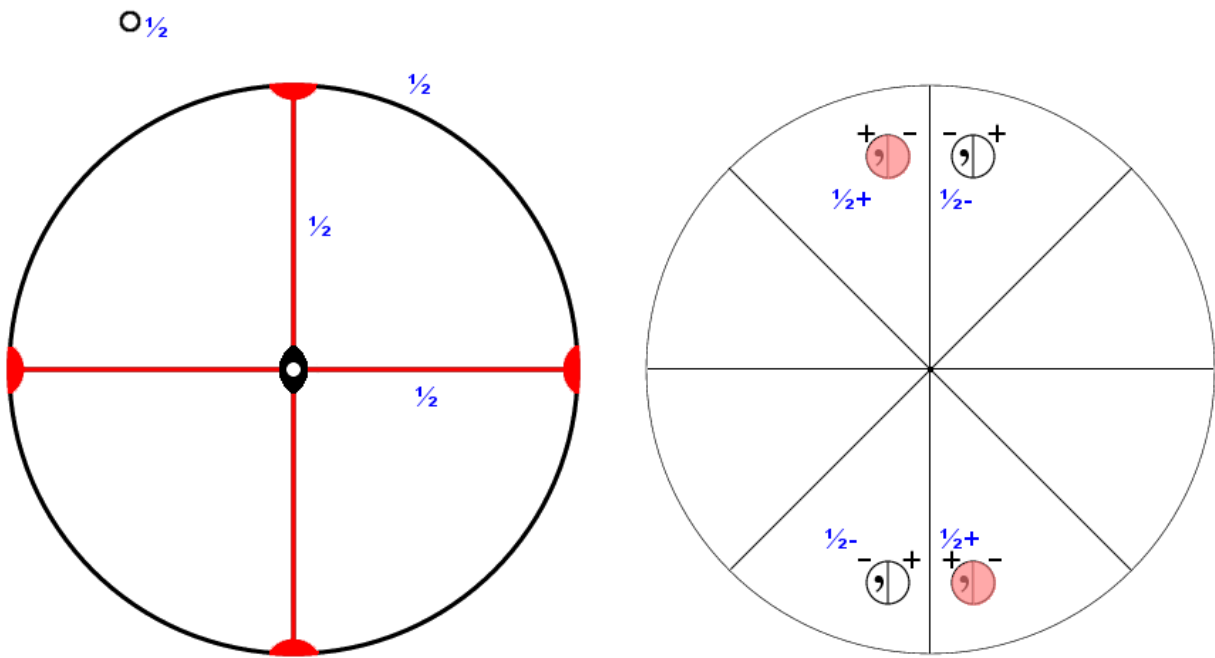

5.3.3.41

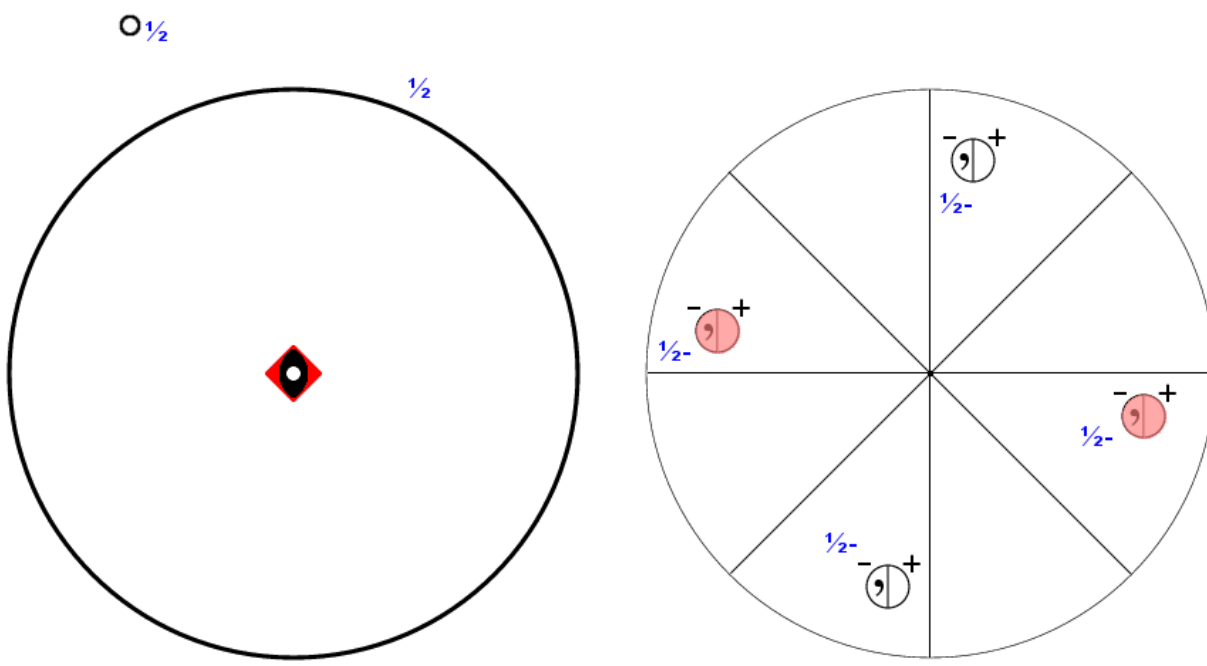

5.3.4.42

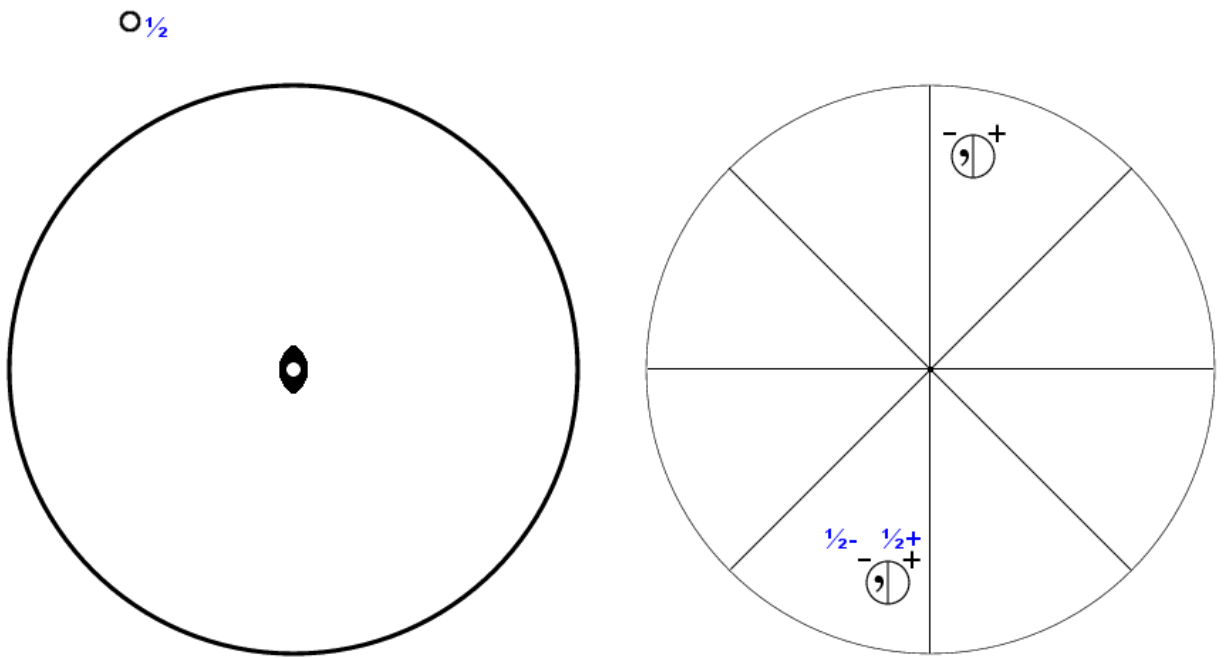

5.4.1.43

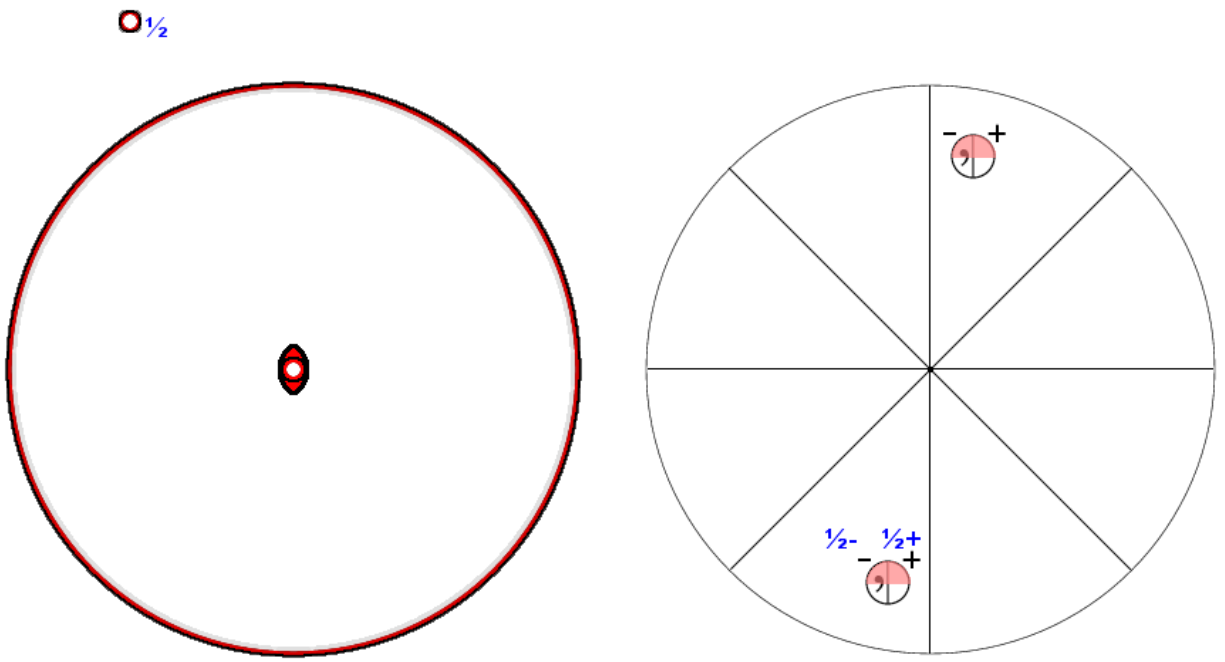

5.4.2.44

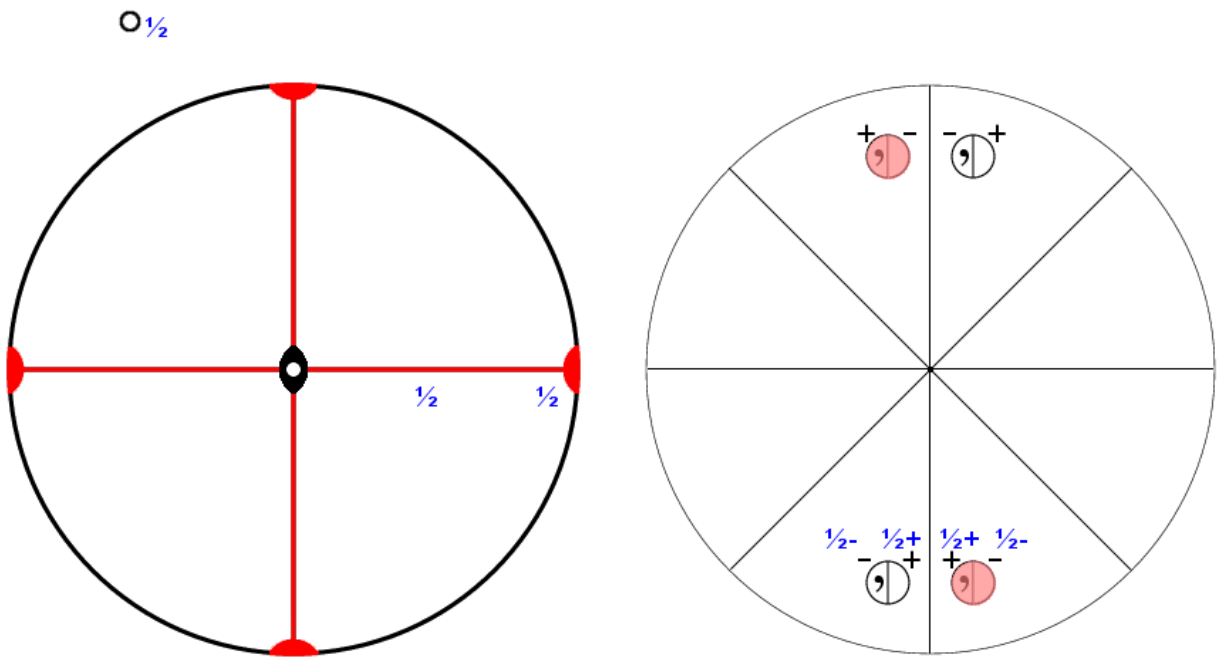

5.4.3.45

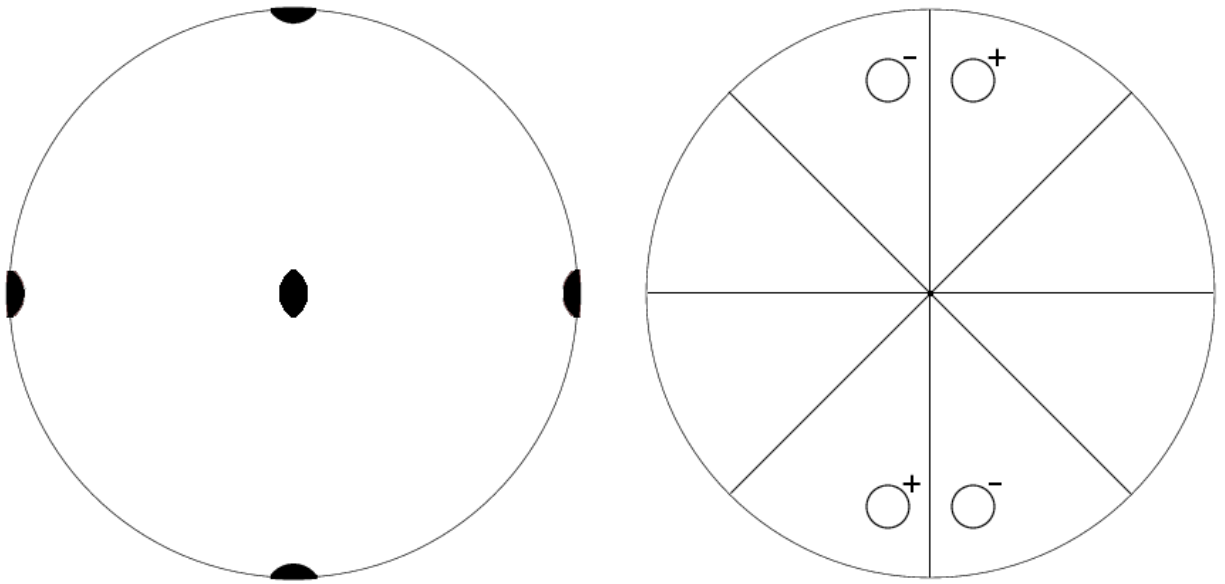

6.1.1.46

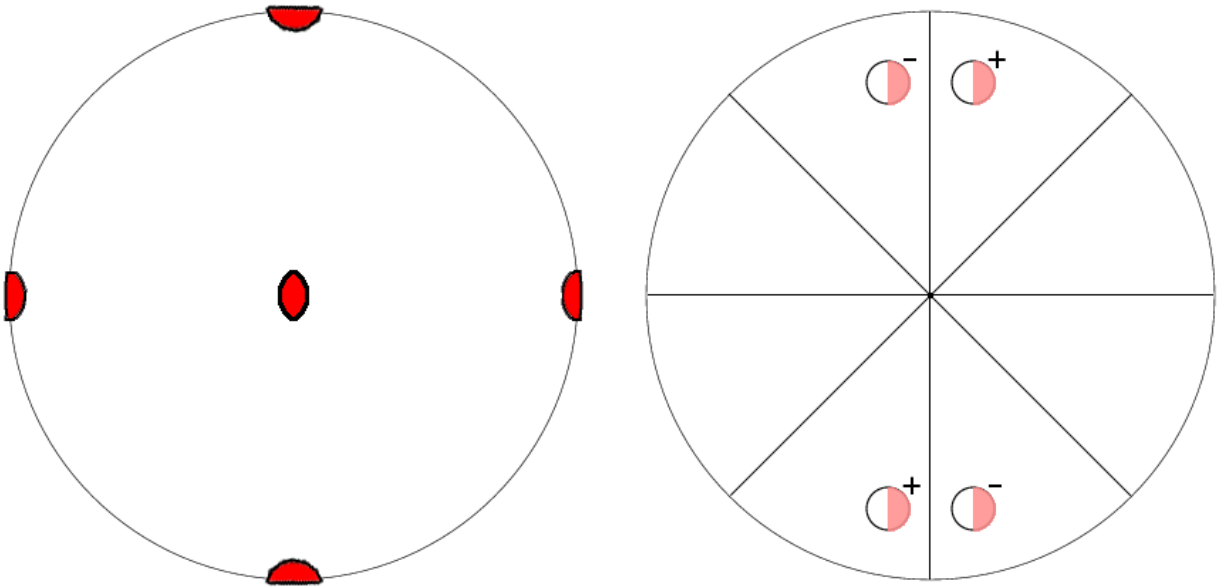

6.1.2.47

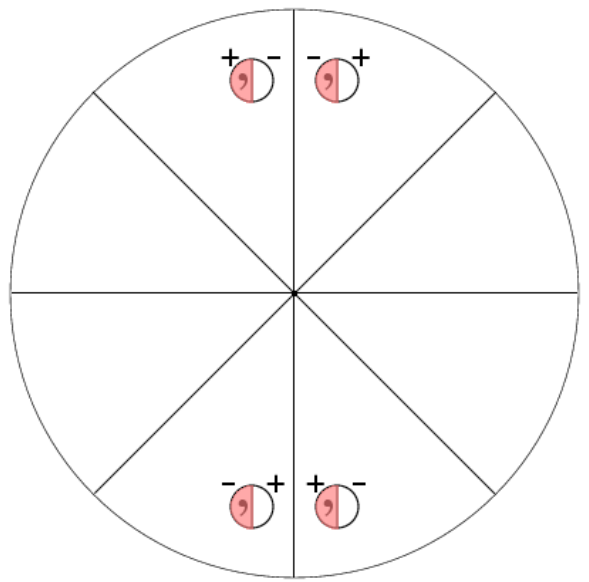
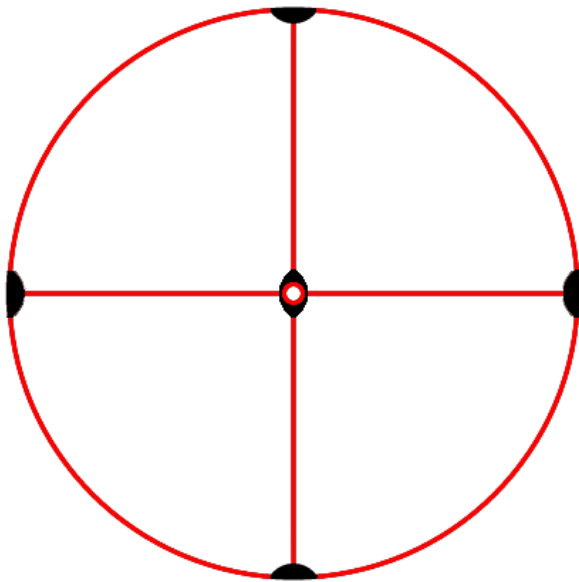

6.1.3.48

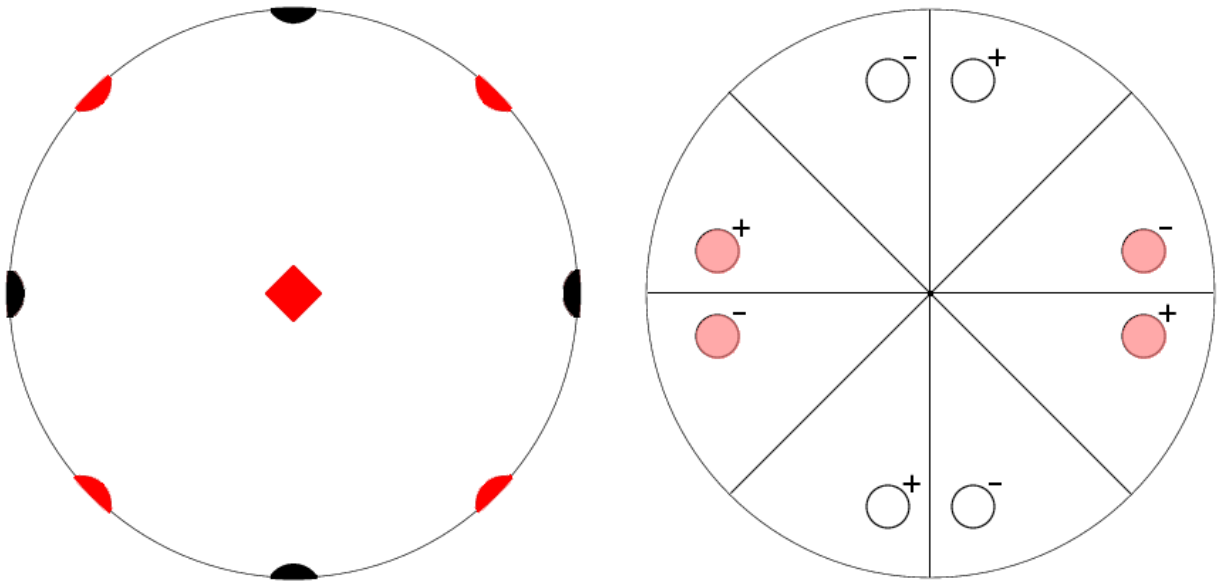

6.1.4.49

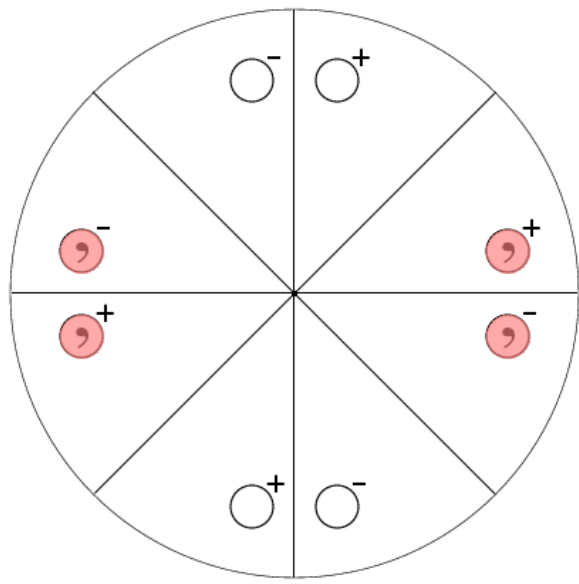
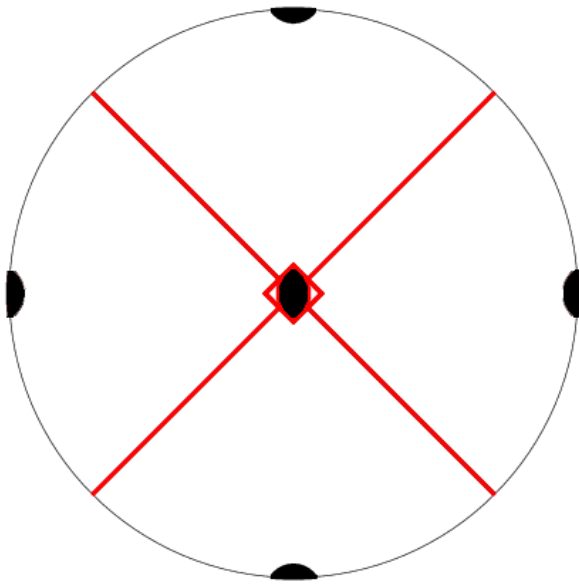

6.1.5.50

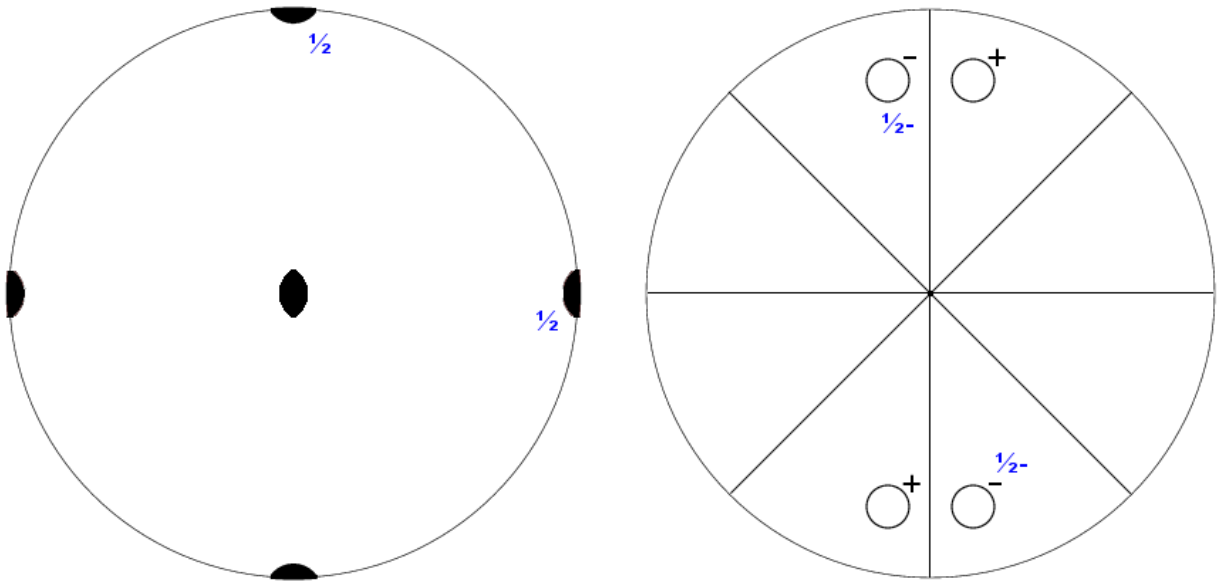

6.2.1.51

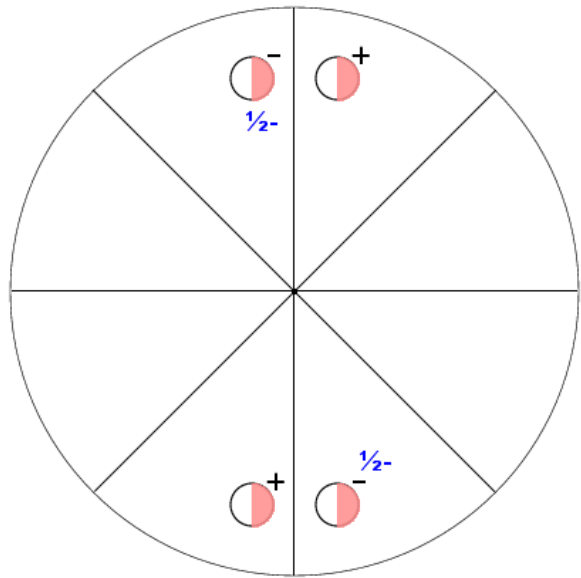
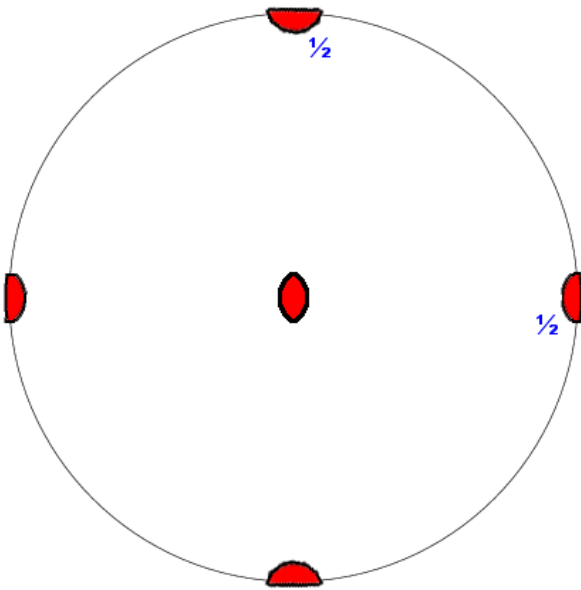

6.2.2.52

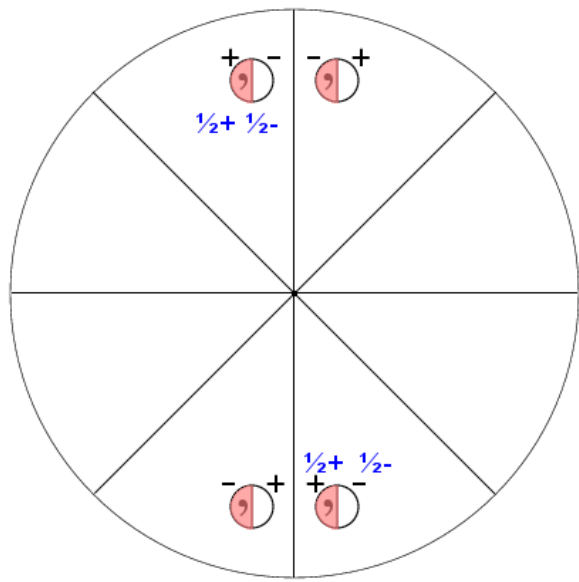
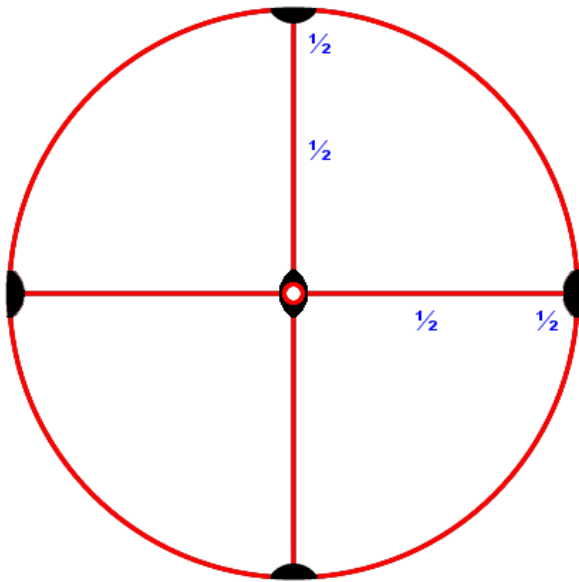

6.2.3.53

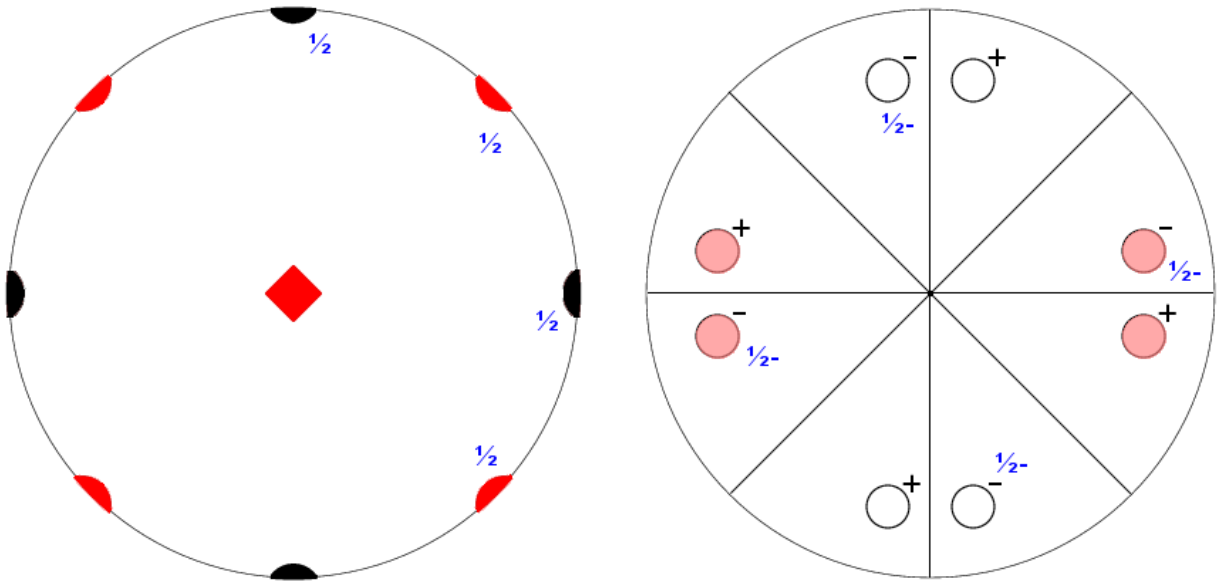

6.2.4.54

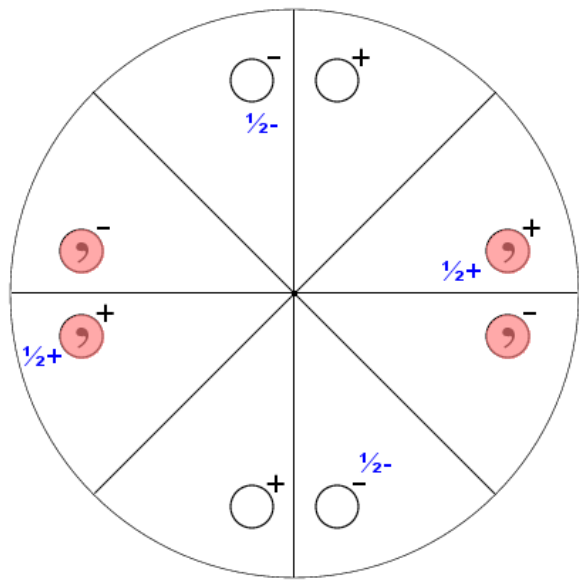
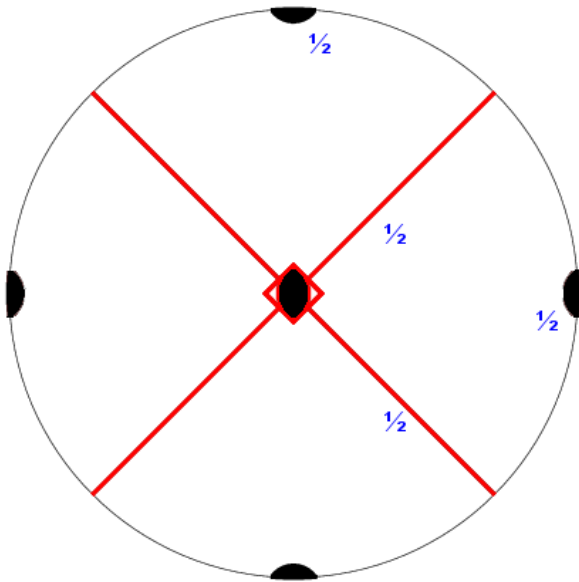

6.2.5.55

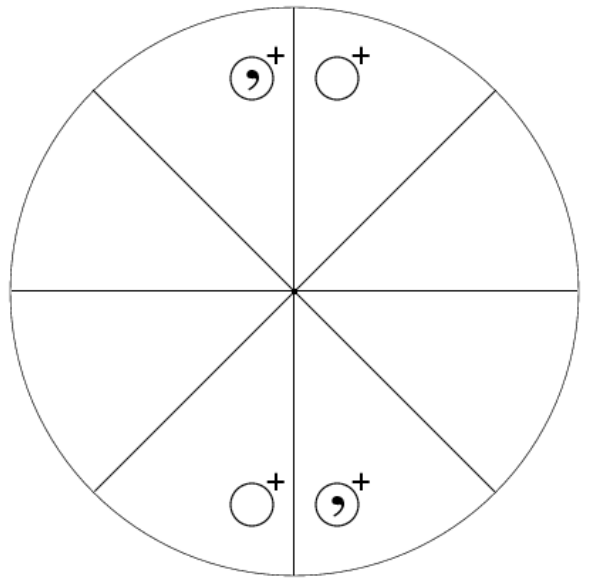
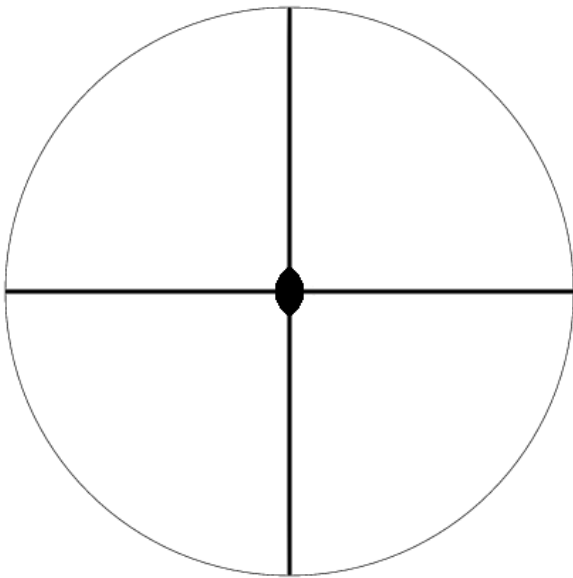

7.1.1.56

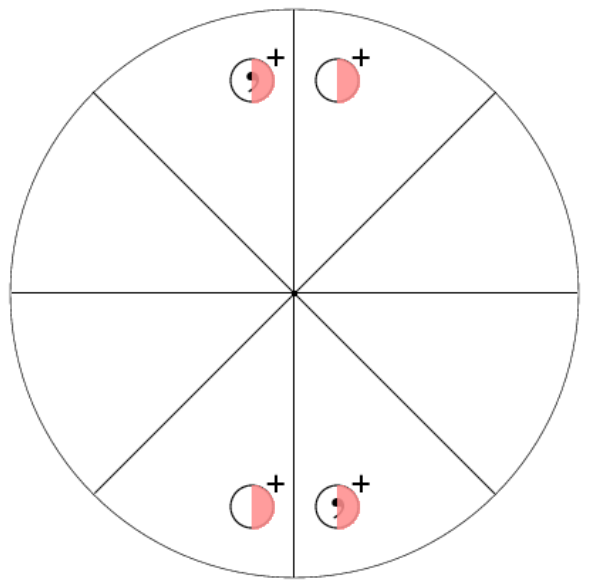
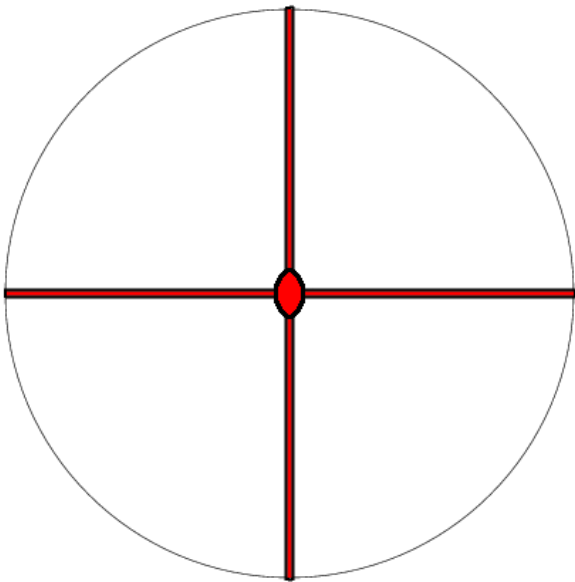

7.1.2.57

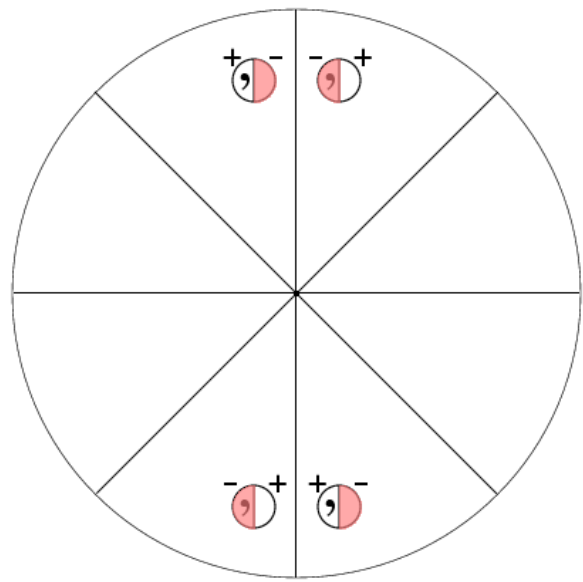
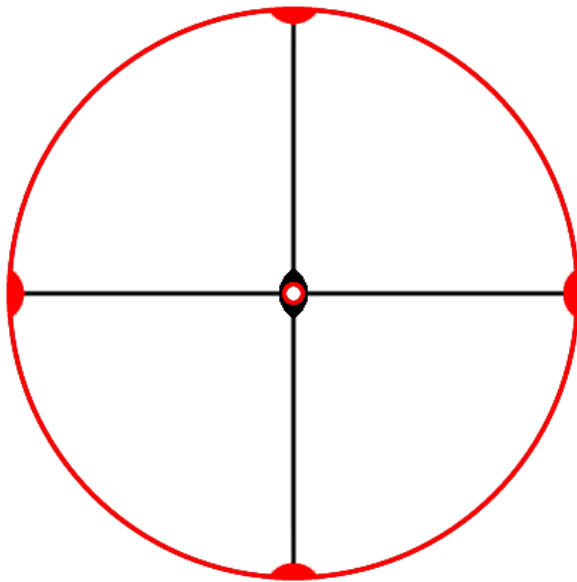

7.1.3.58

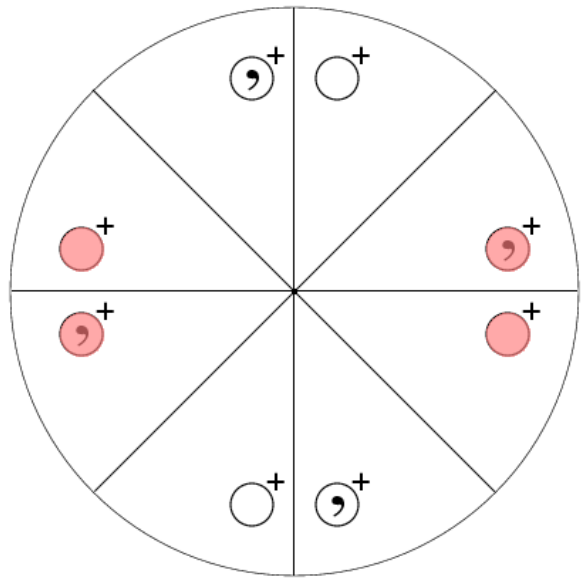
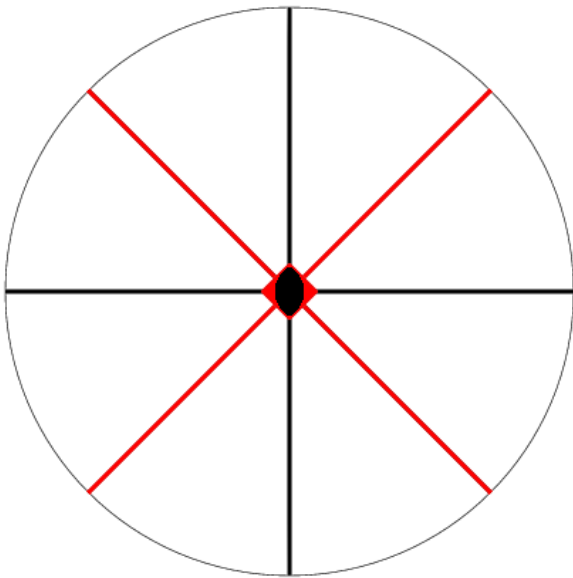

7.1.4.59

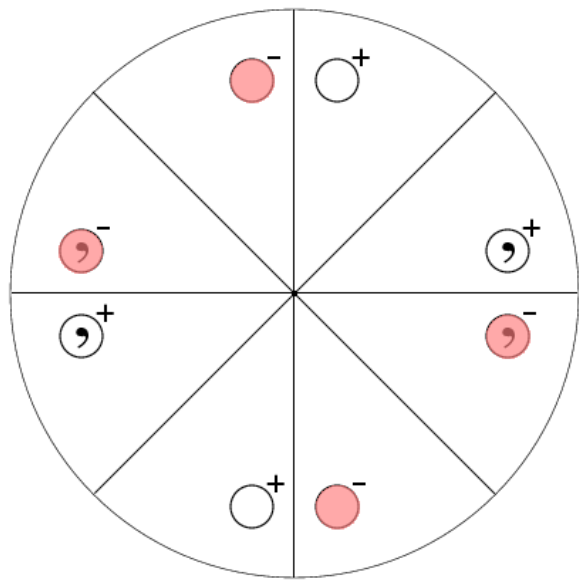
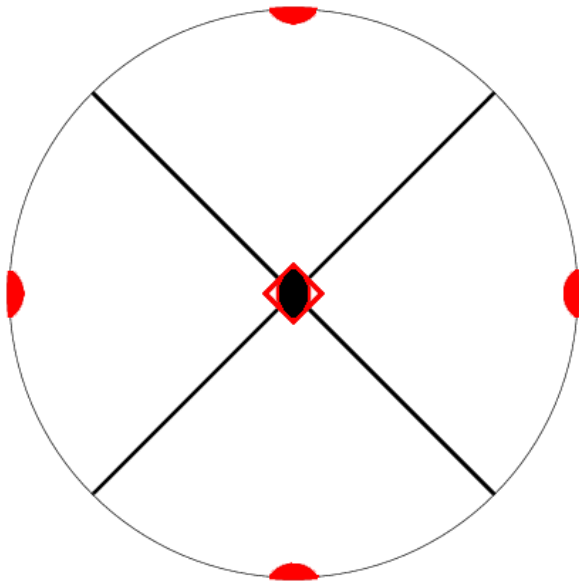

7.1.5.60

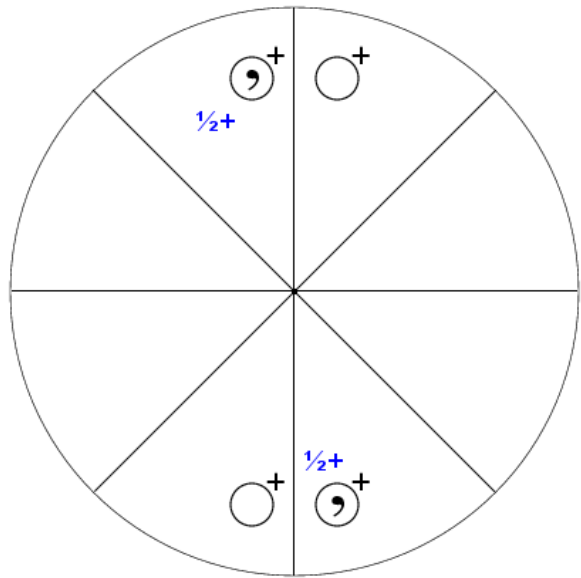
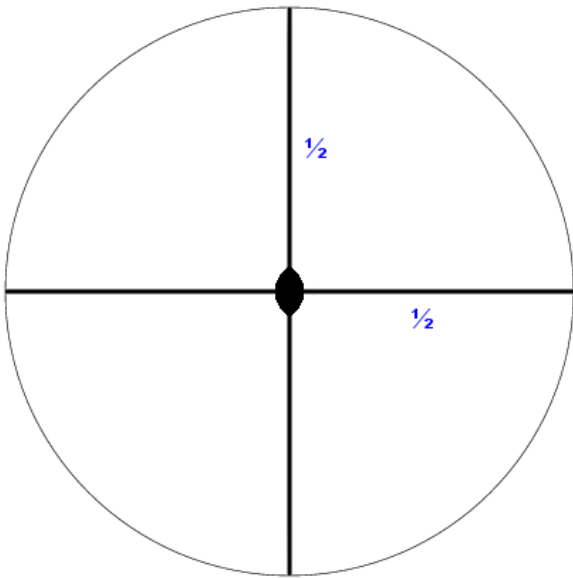

7.2.1.61

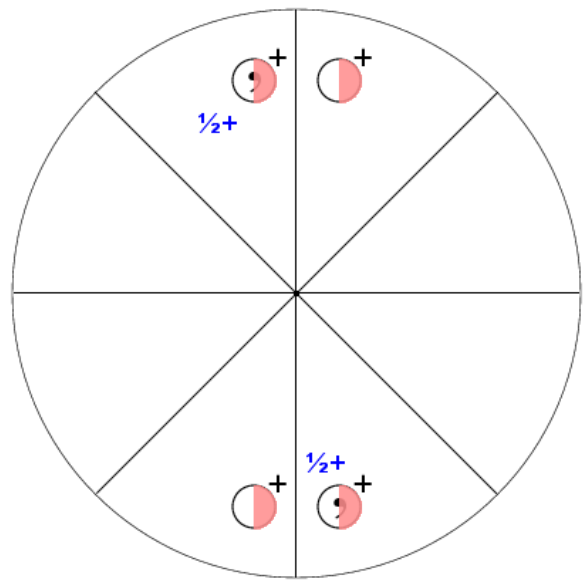
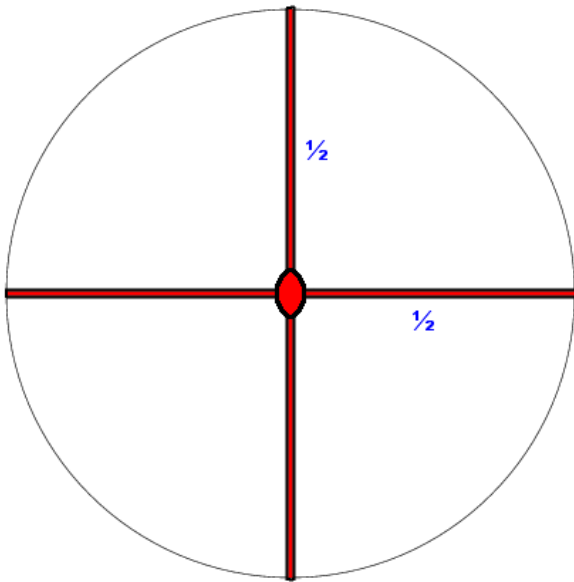

7.2.2.62

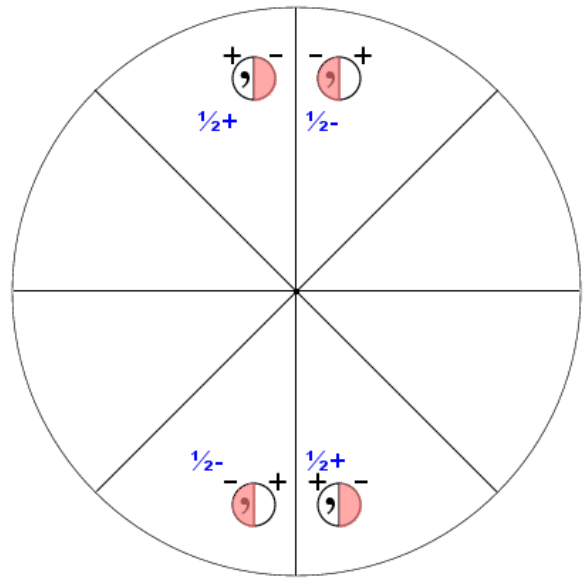
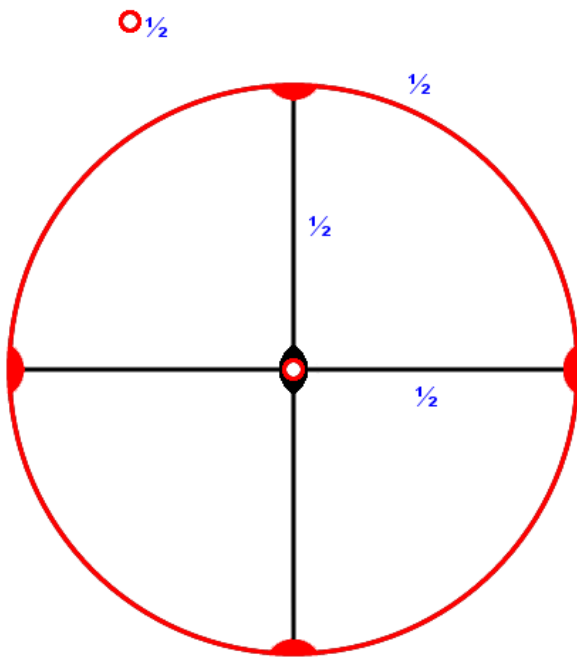

7.2.3.63

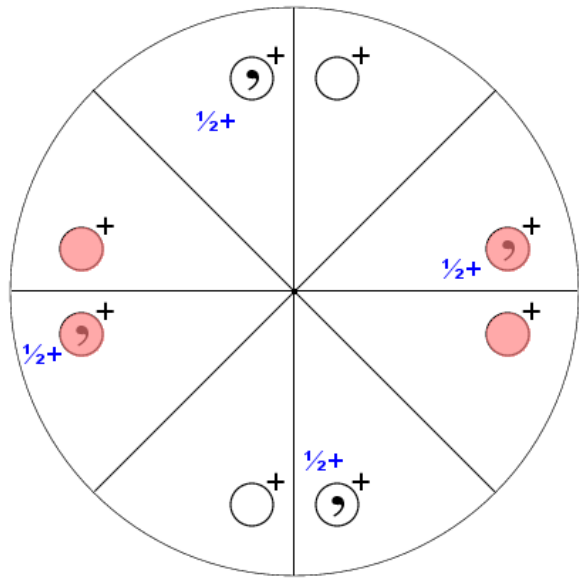
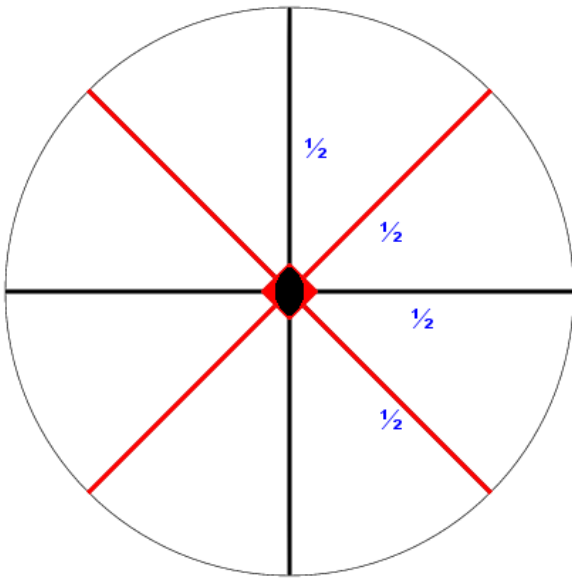

7.2.4.64

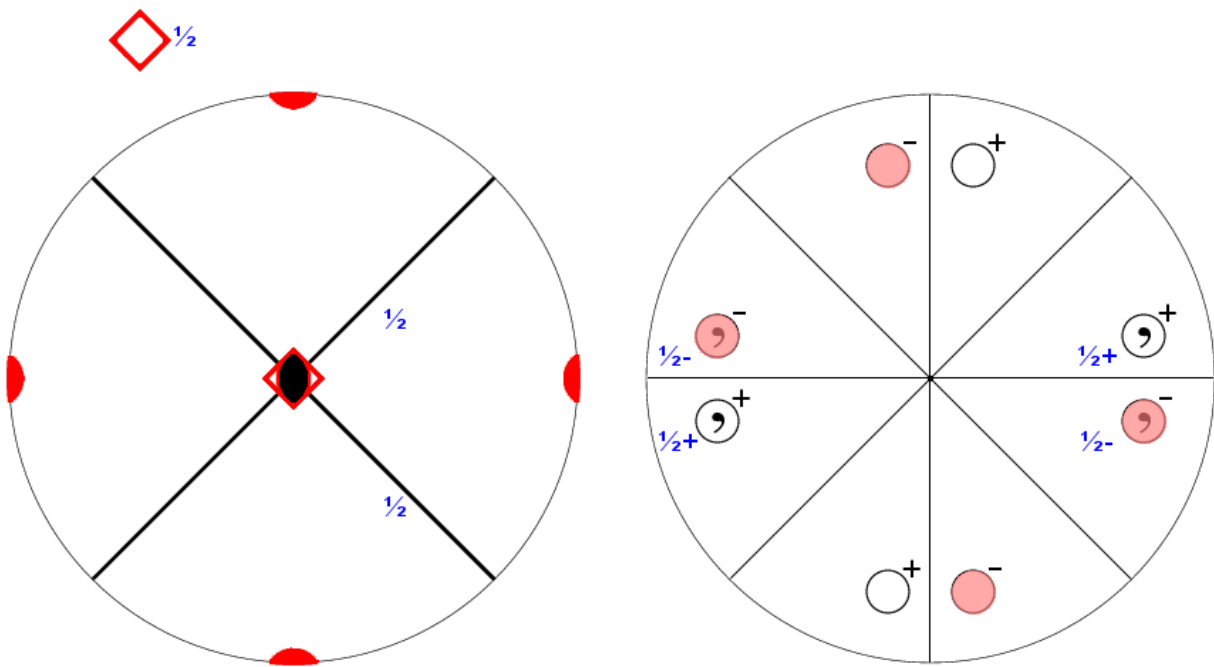

7.2.5.65

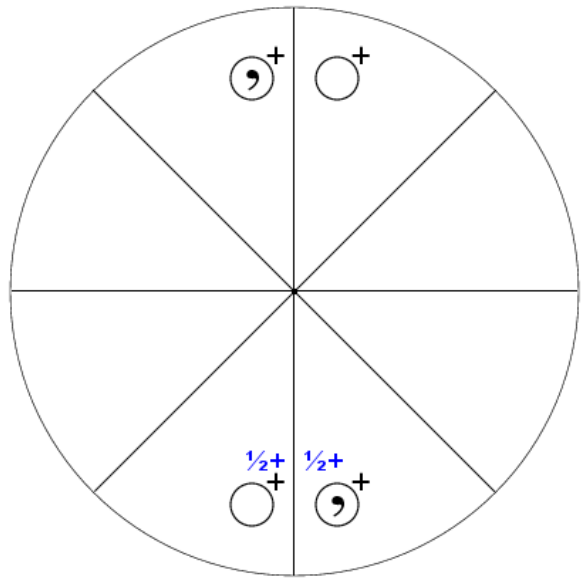
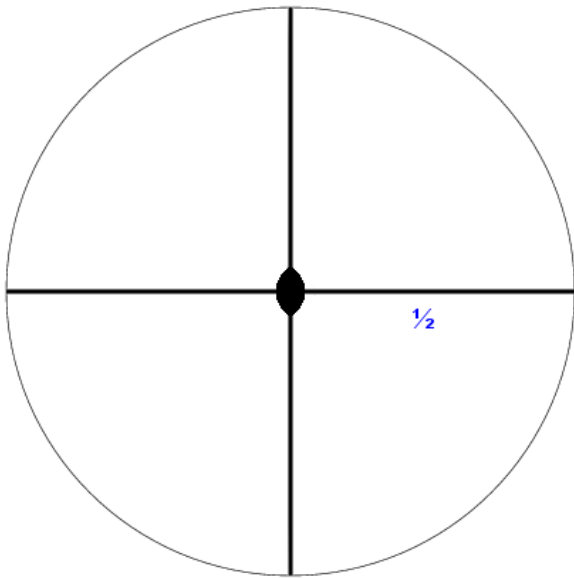

7.3.1.66

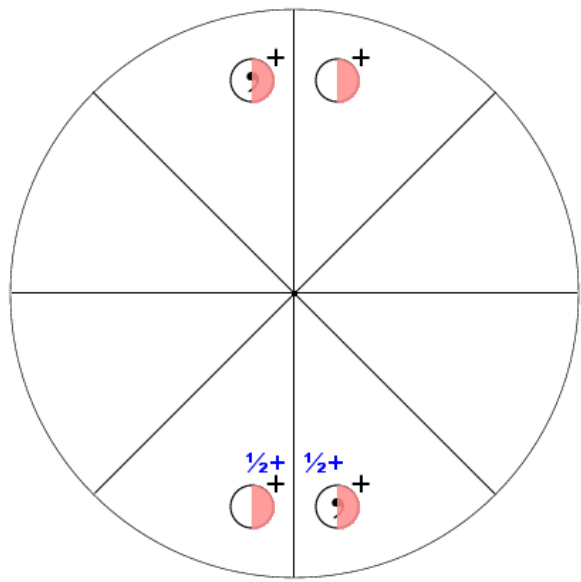
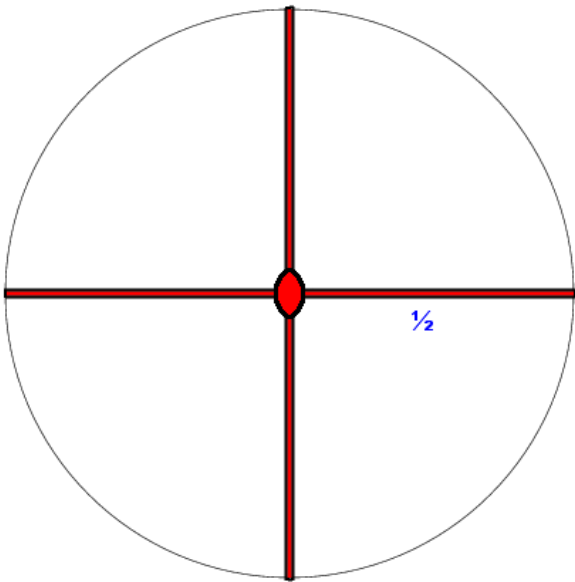

7.3.2.67

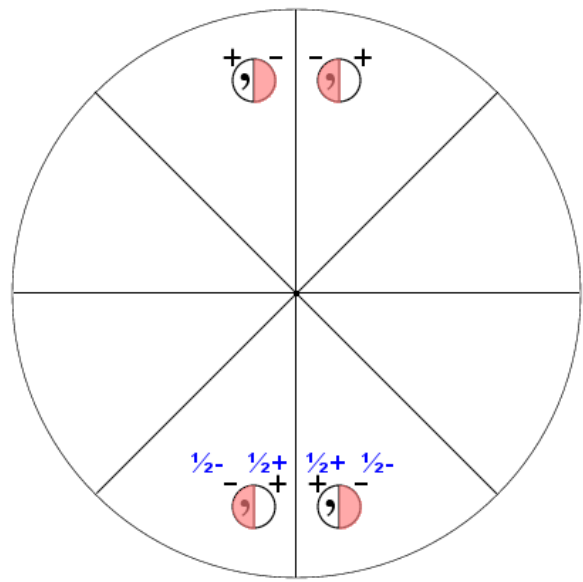
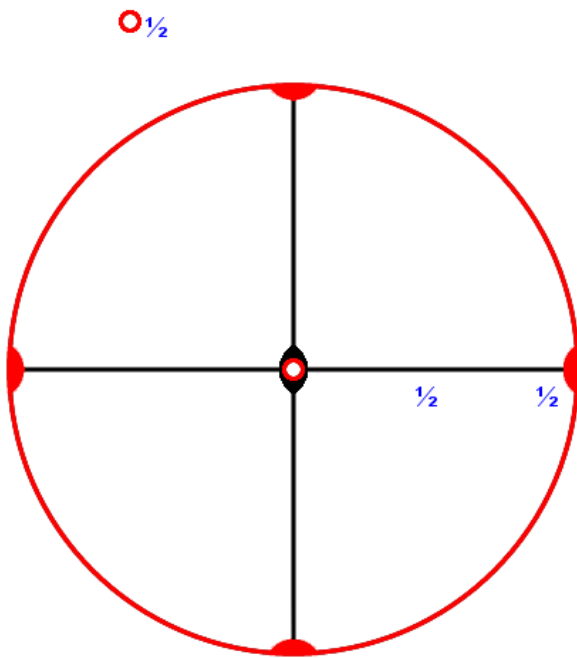

7.3.3.68

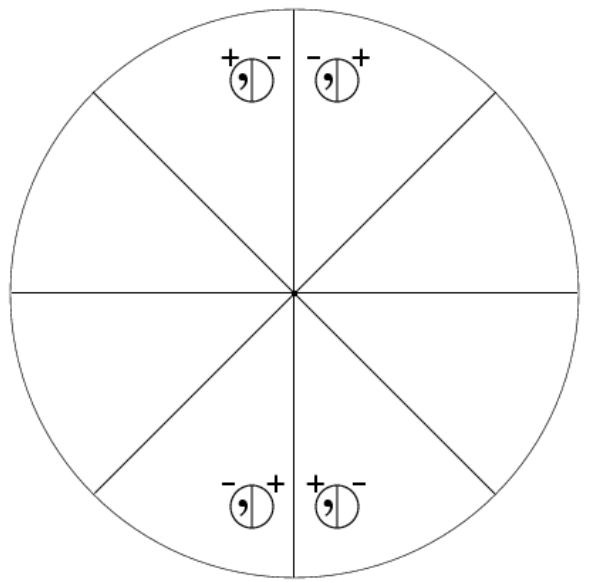
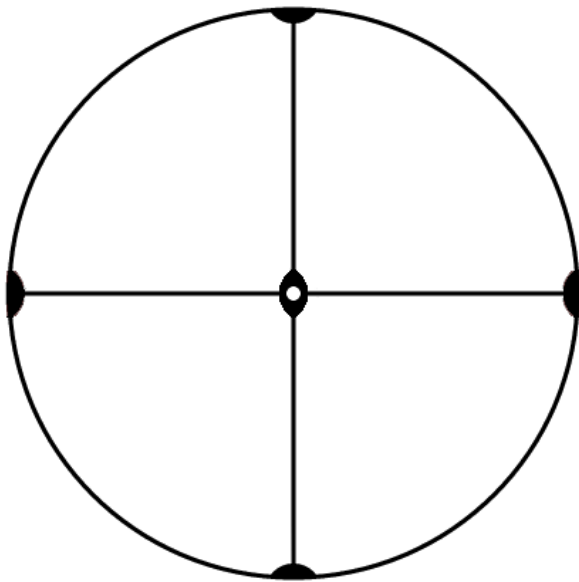

8.1.1.69

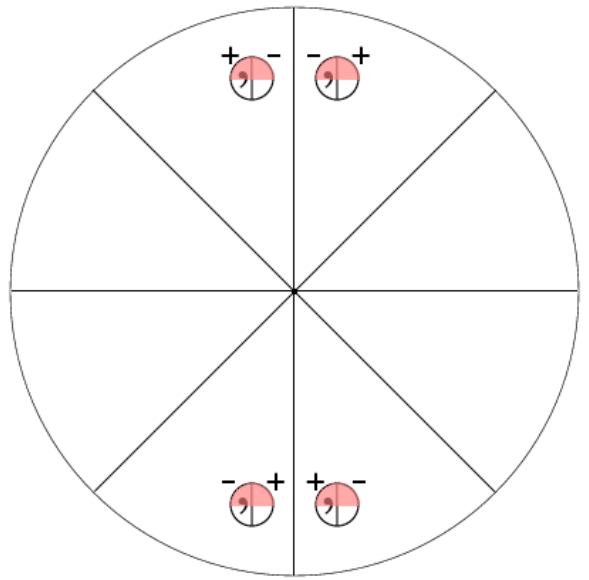
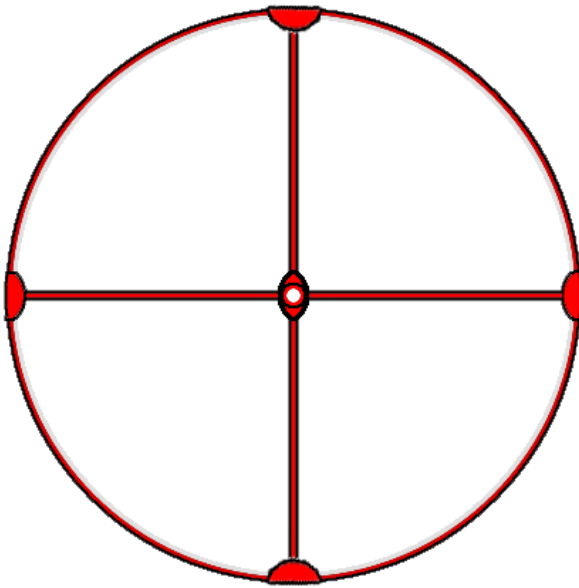

8.1.2.70

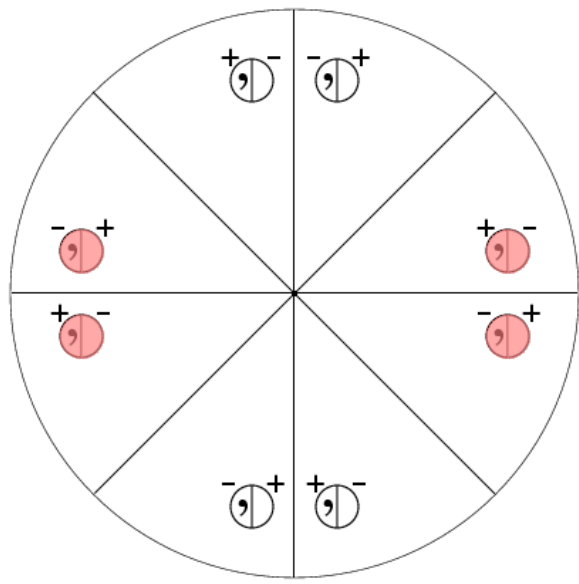
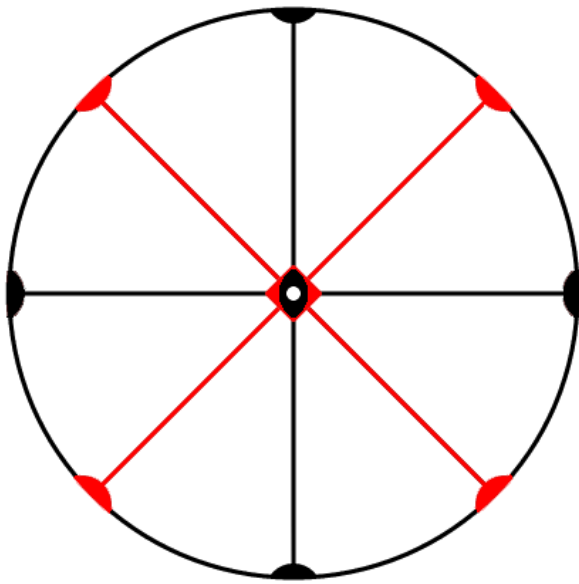

8.1.3.71

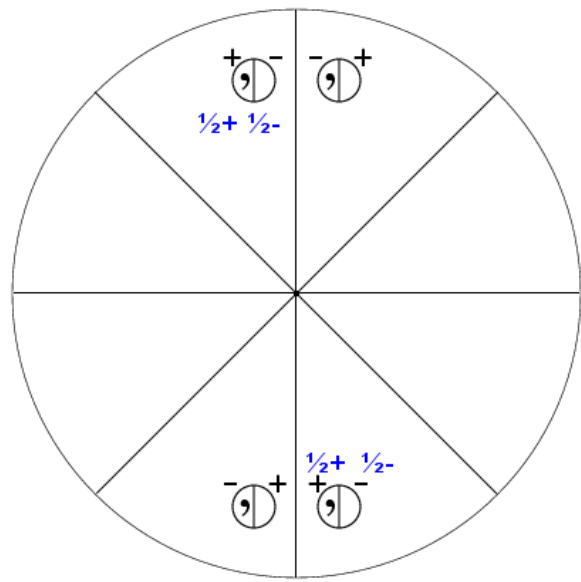
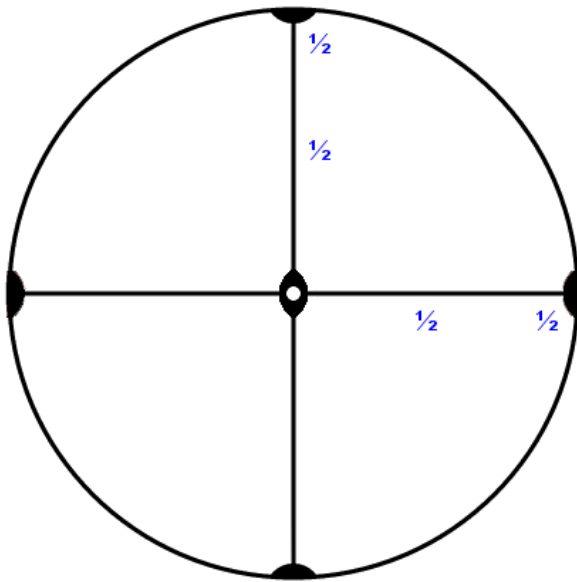

8.2.1.72

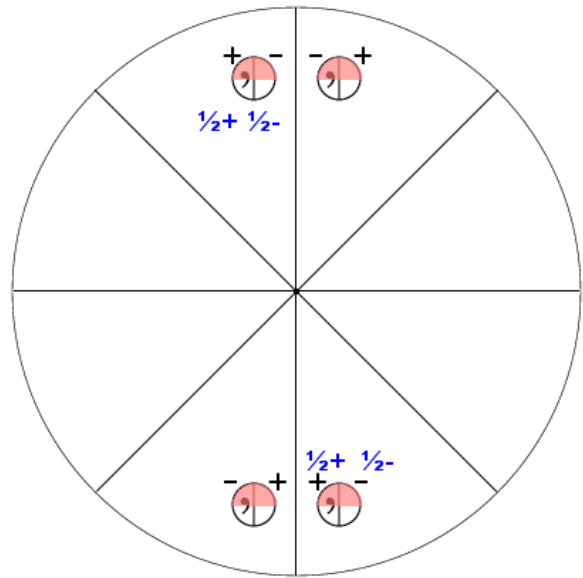
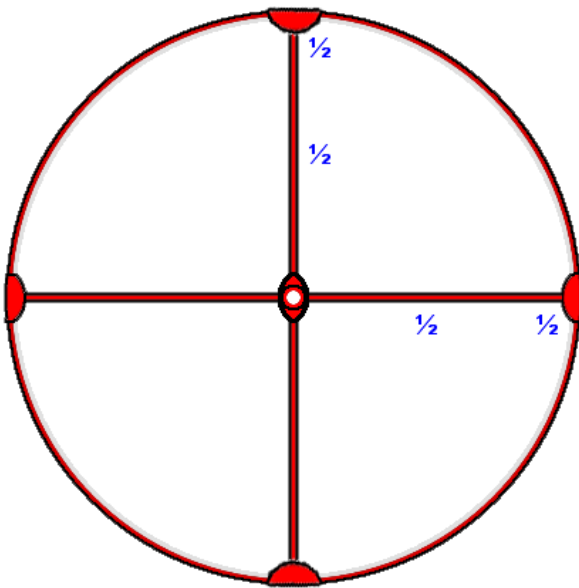

8.2.2.73

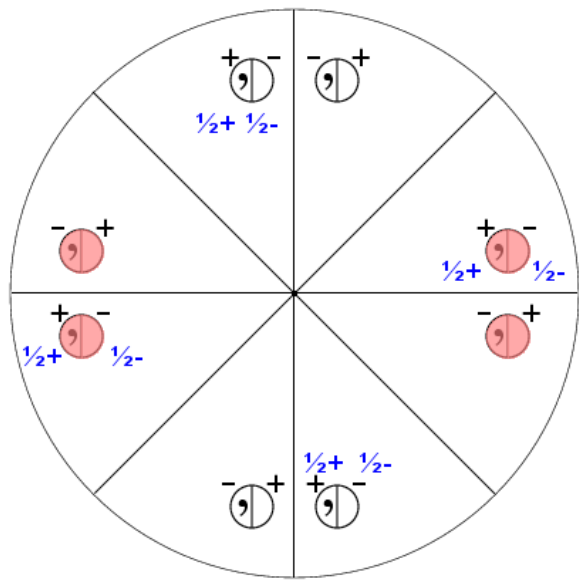
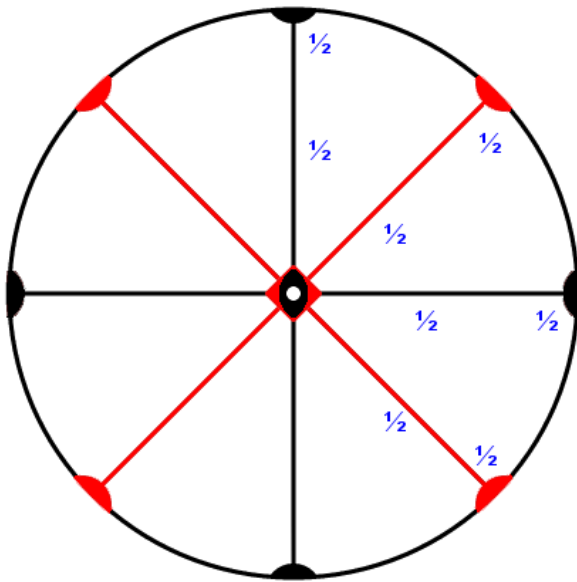

8.2.3.74

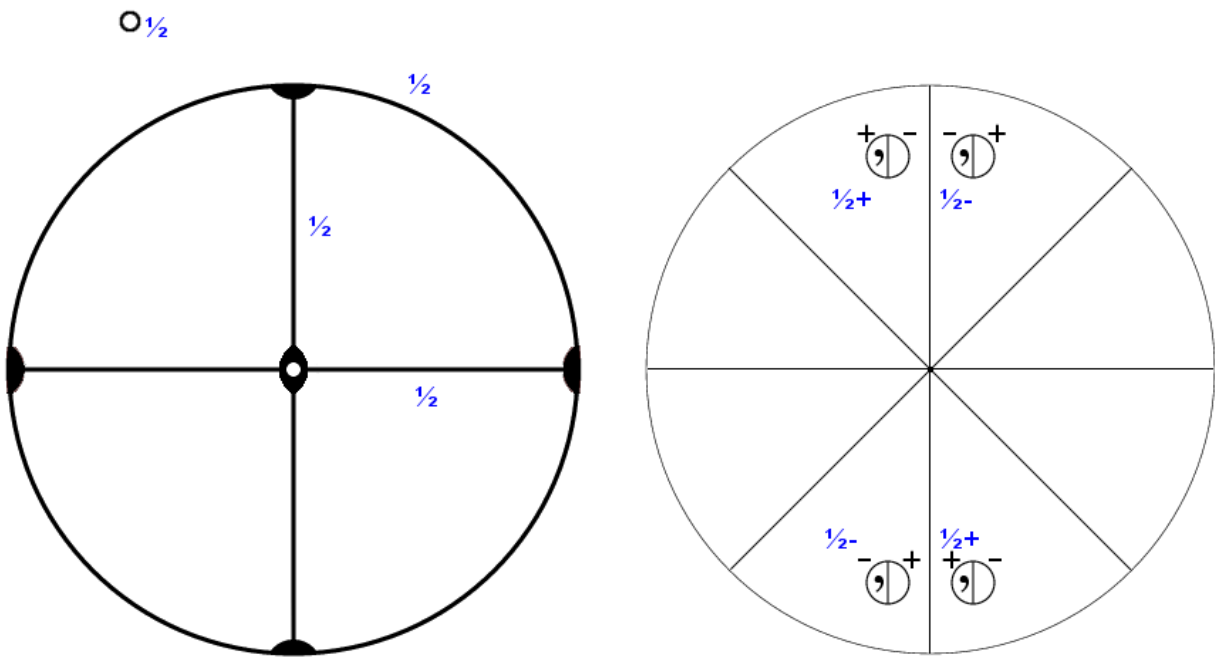

8.3.1.75

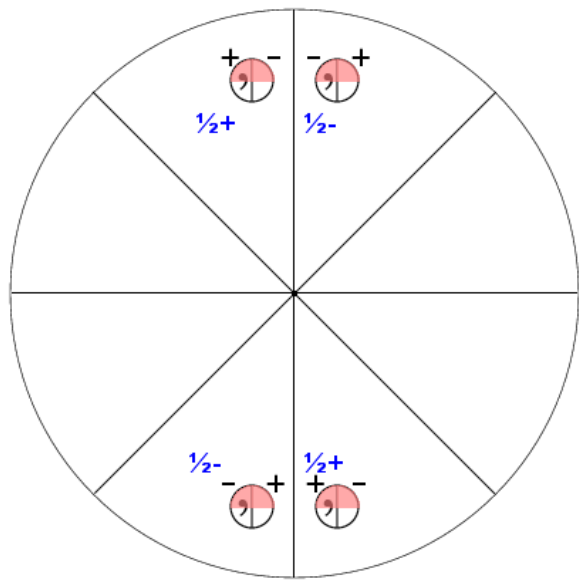
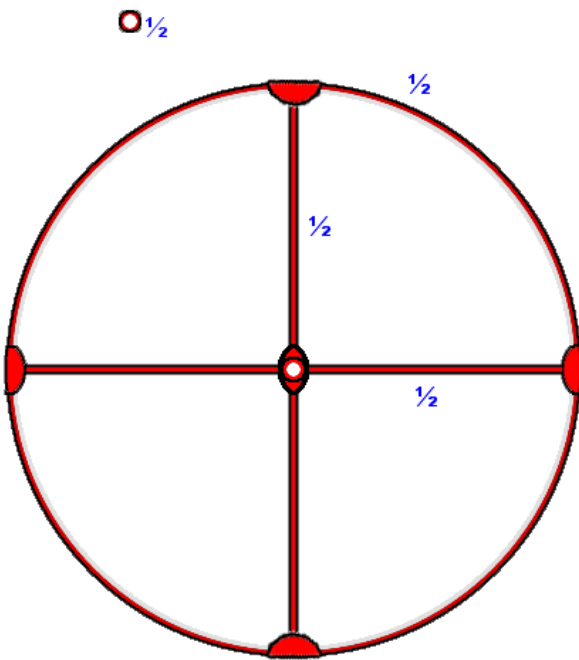

8.3.2.76

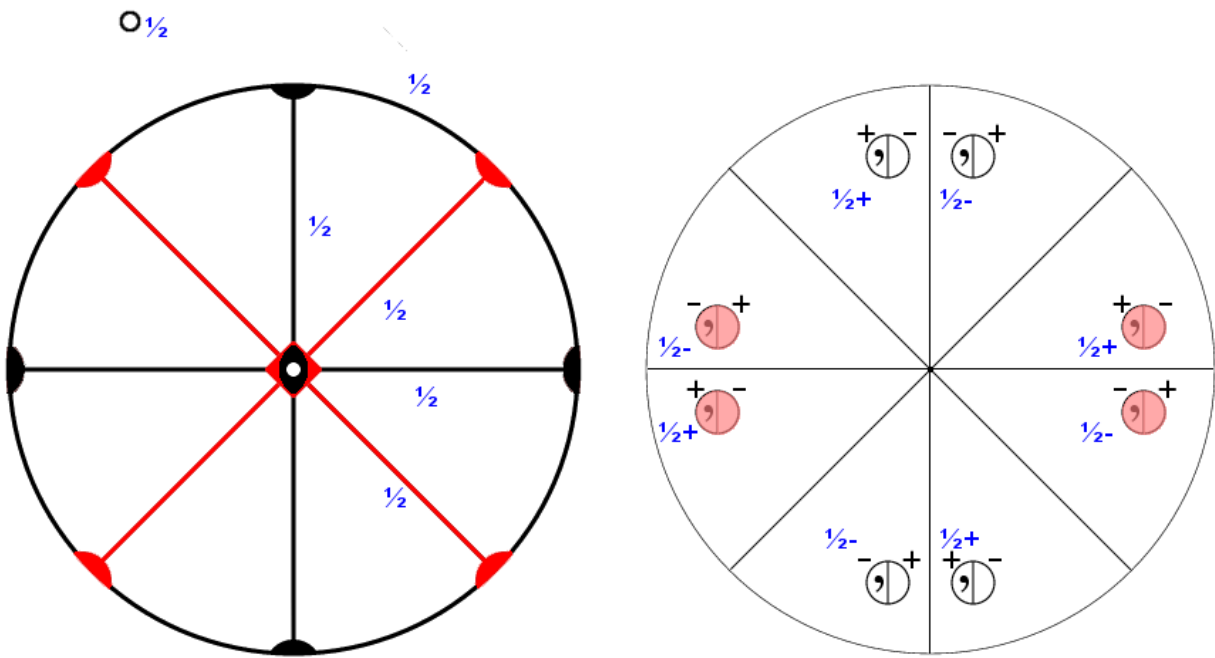

8.3.3.77

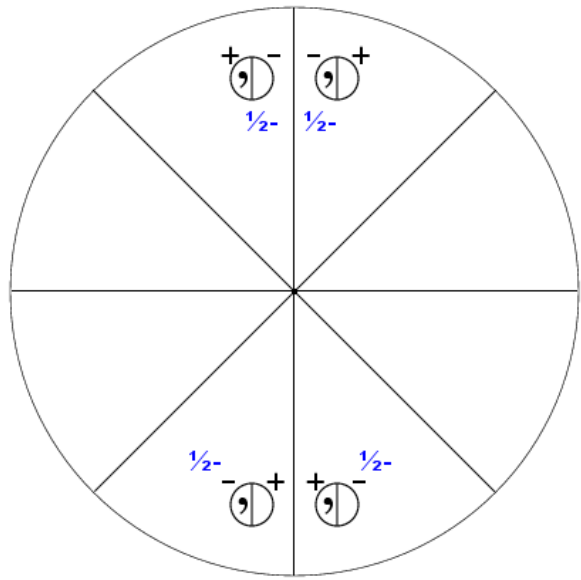
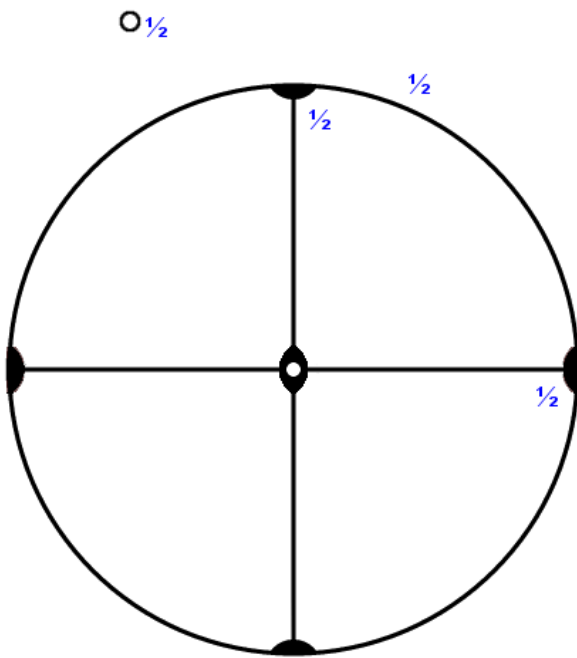

8.4.1.78

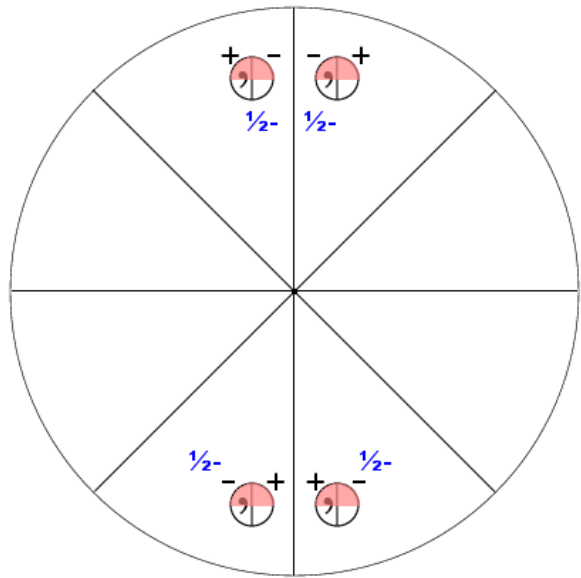
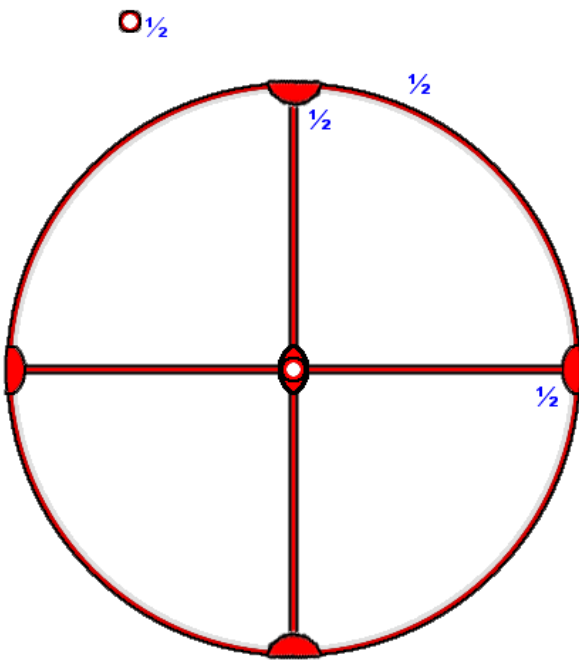

8.4.2.79

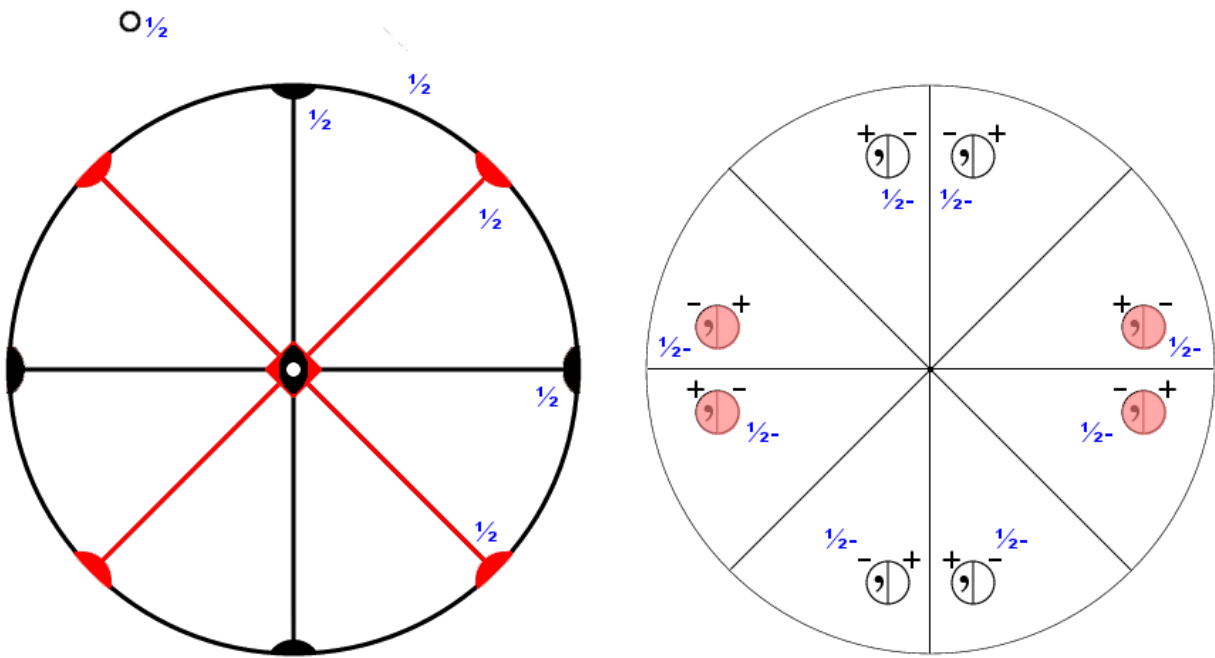

8.4.3.80

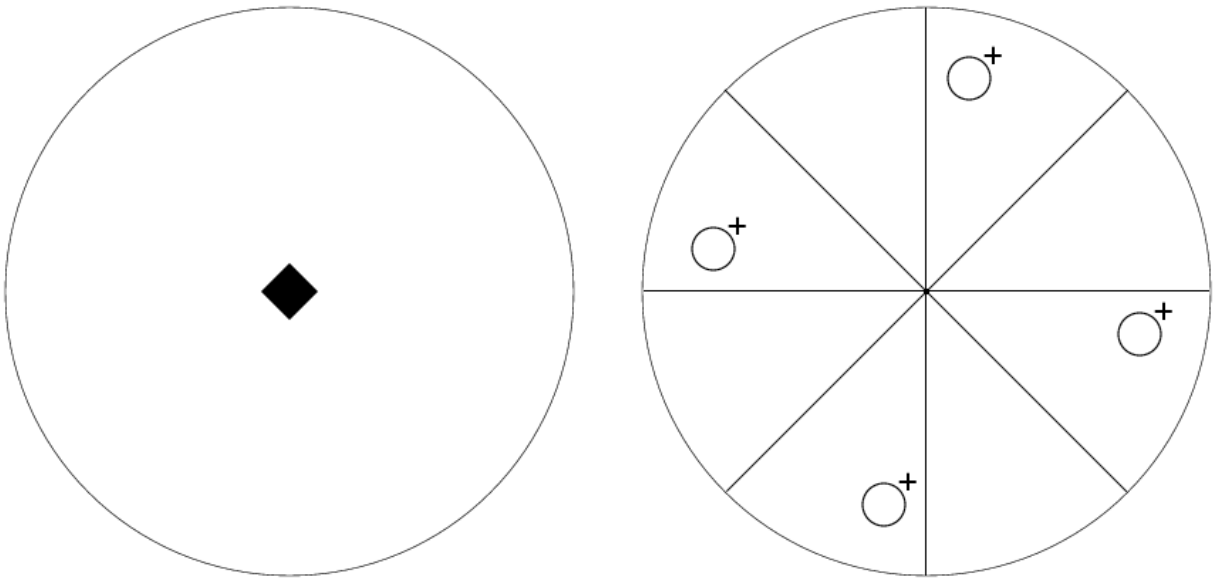

9.1.1.81

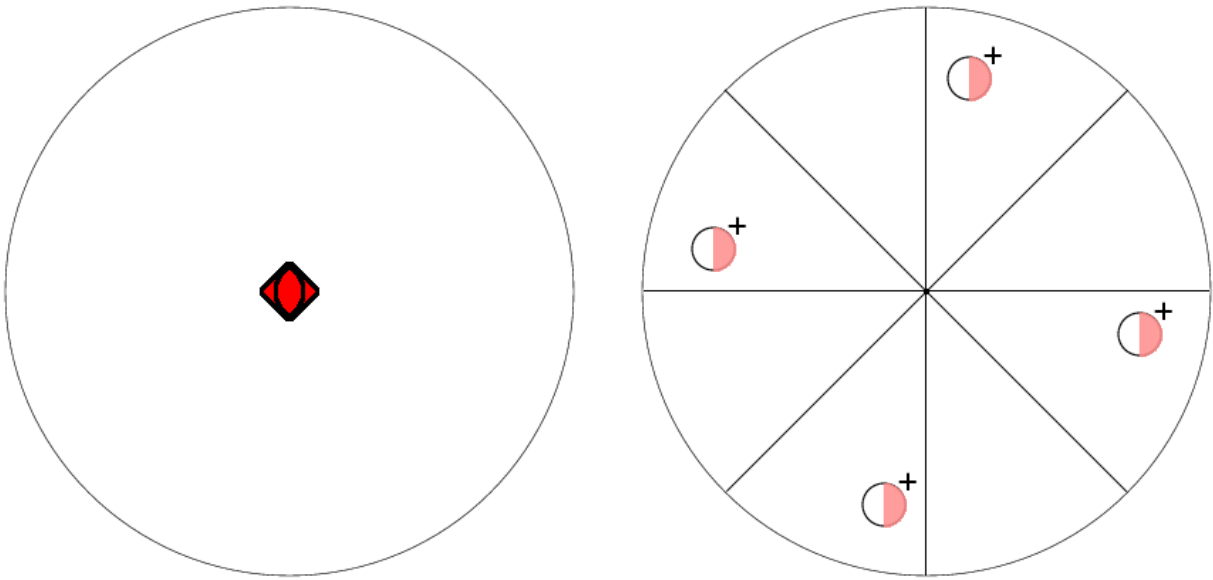

9.1.2.82

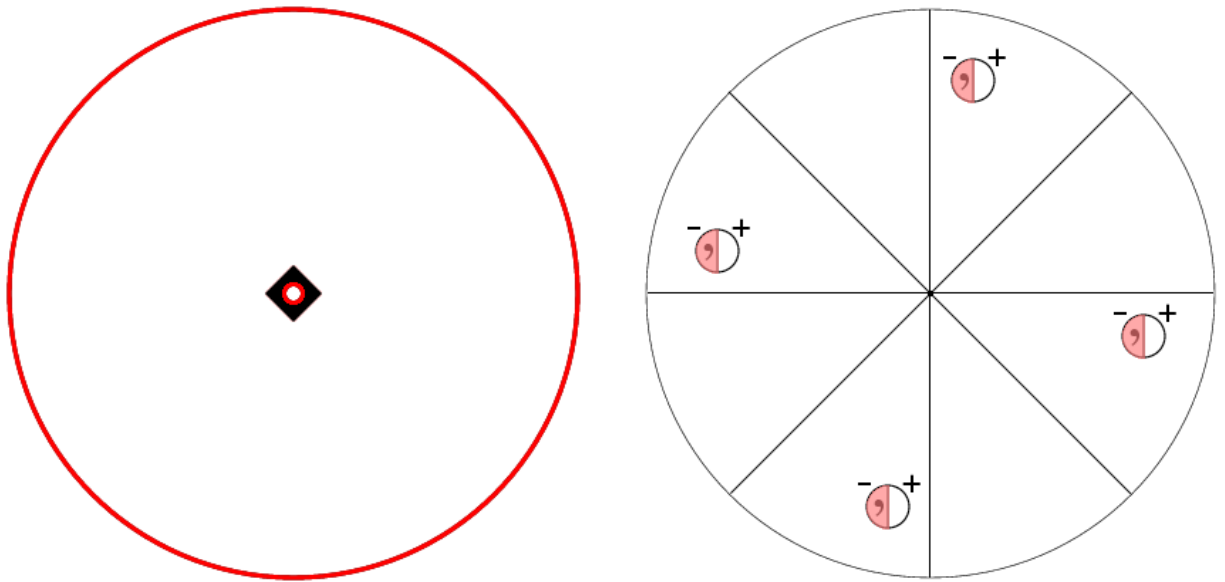

9.1.3.83

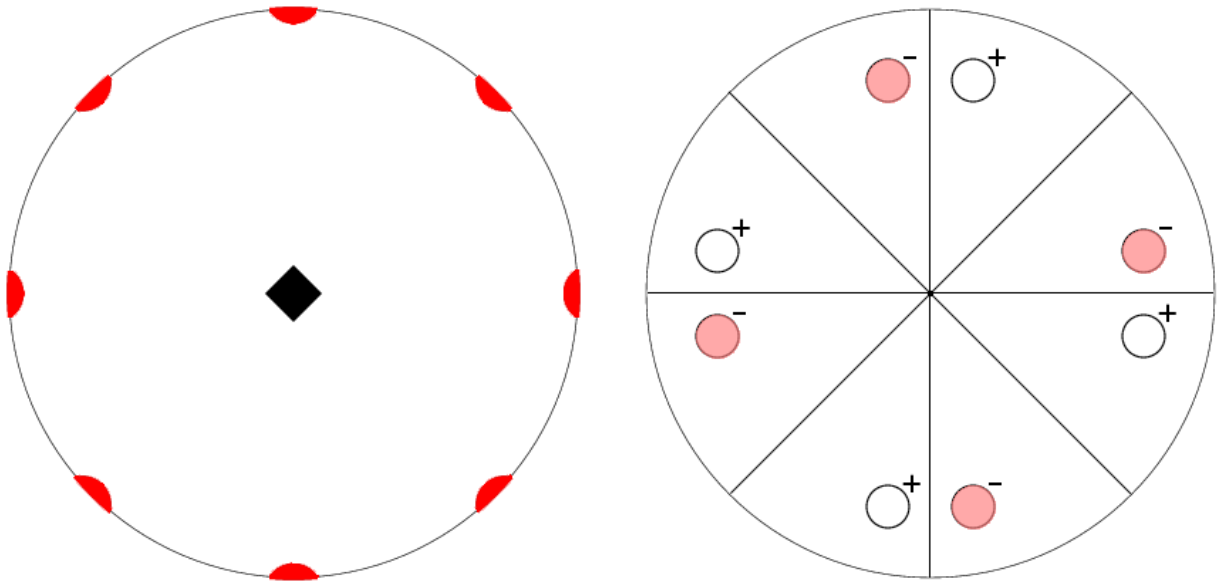

9.1.4.84

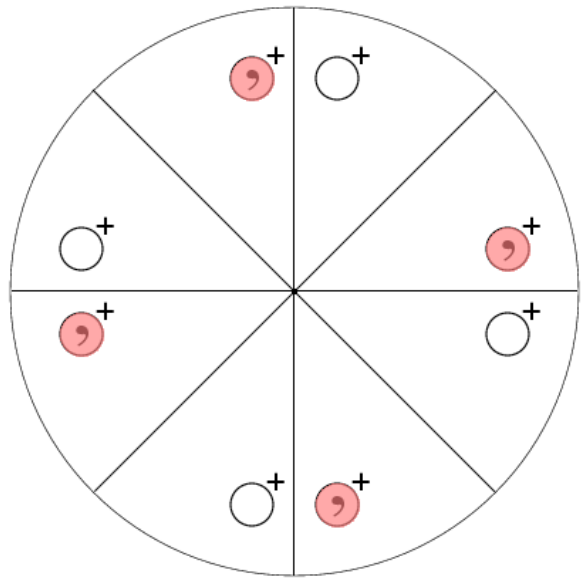
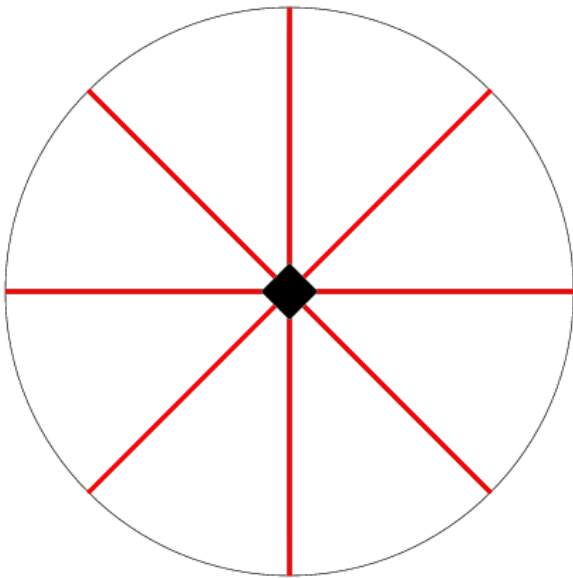

9.1.5.85

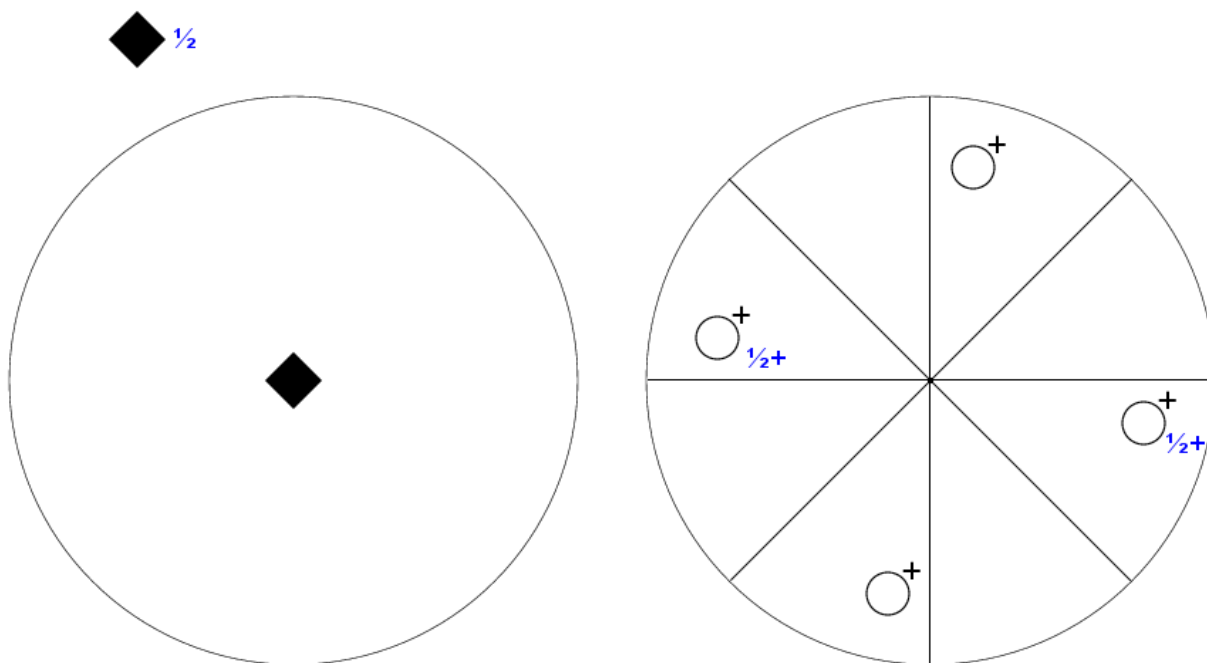

9.2.1.86

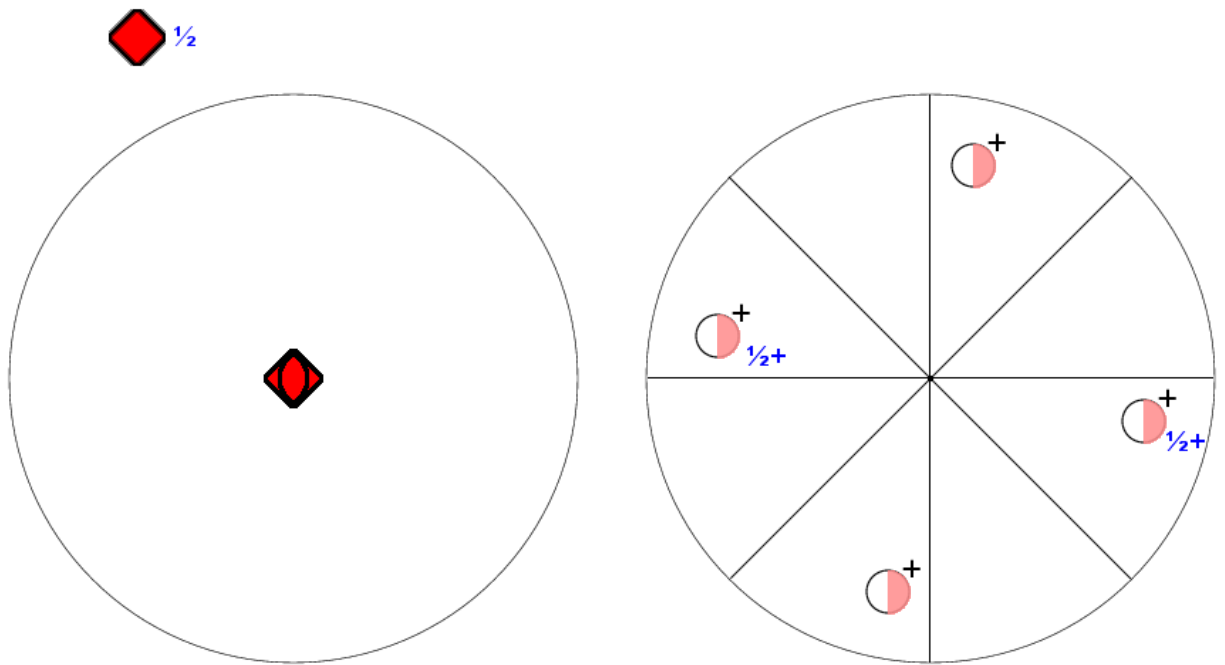

9.2.2.87

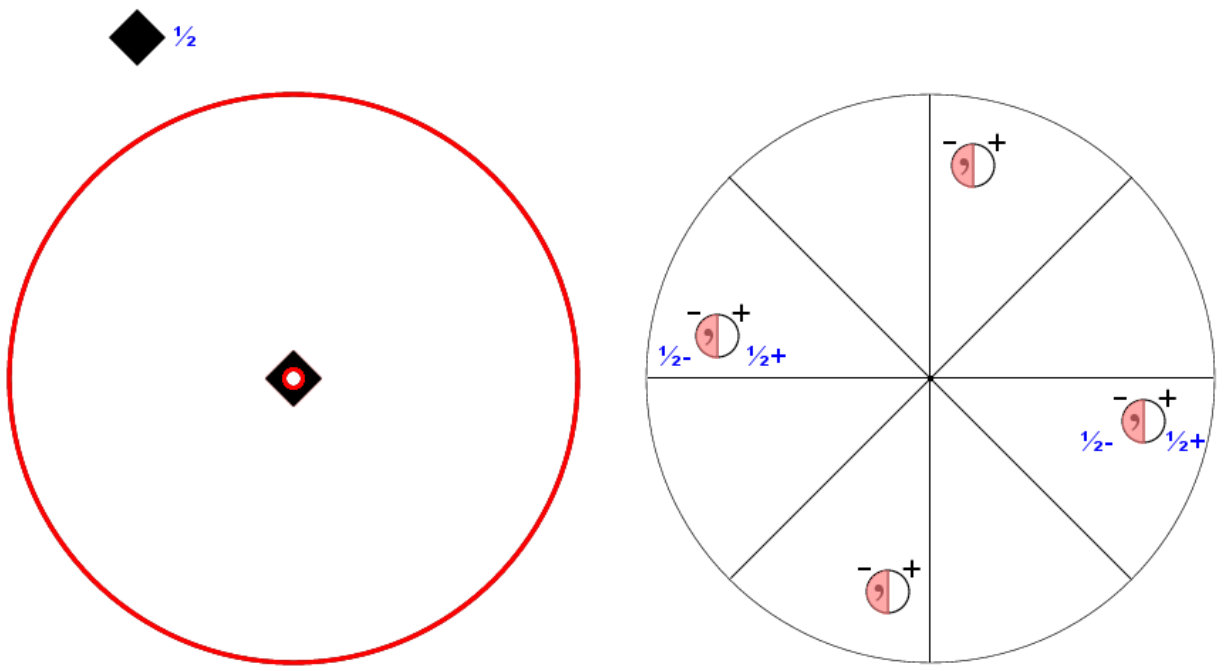

9.2.3.88

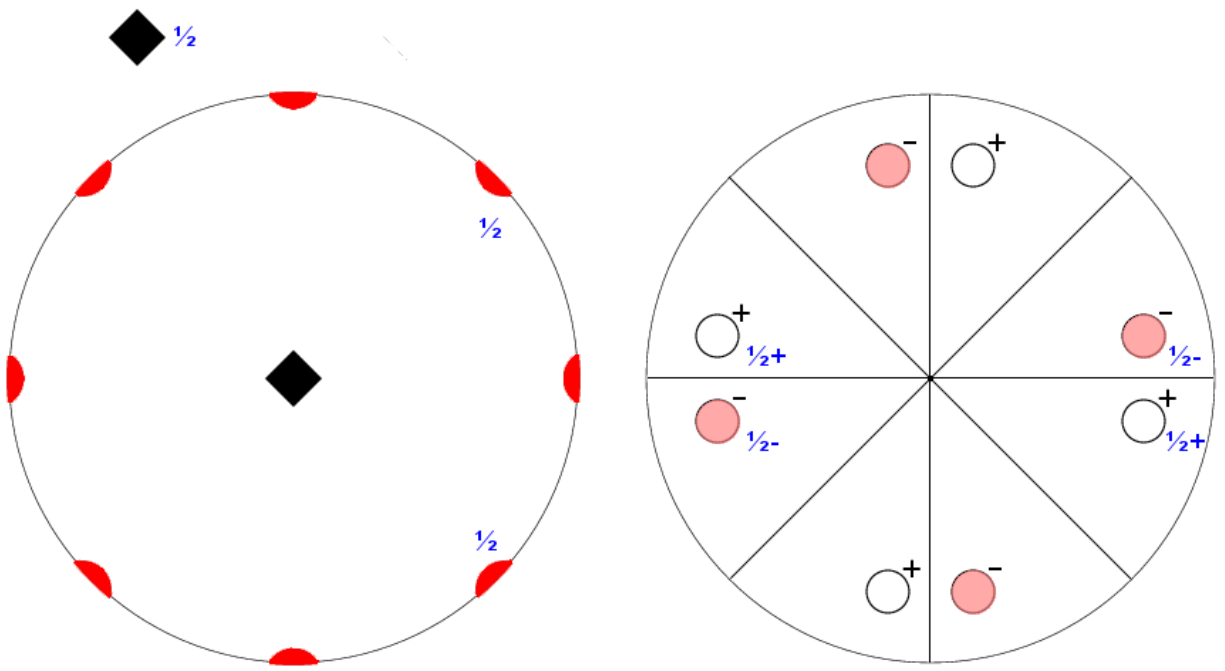

9.2.4.89

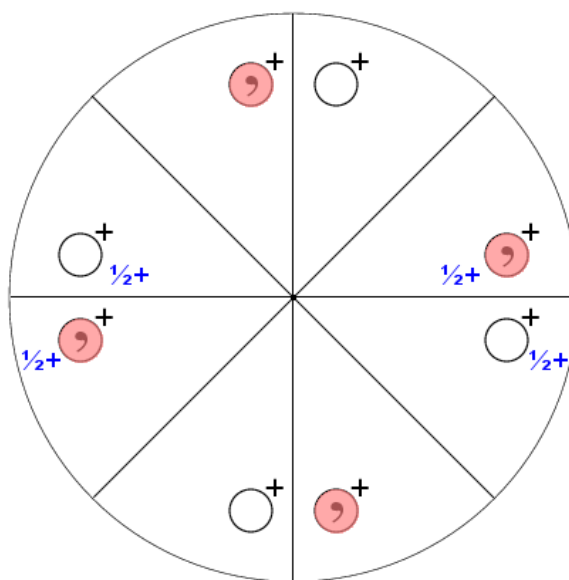
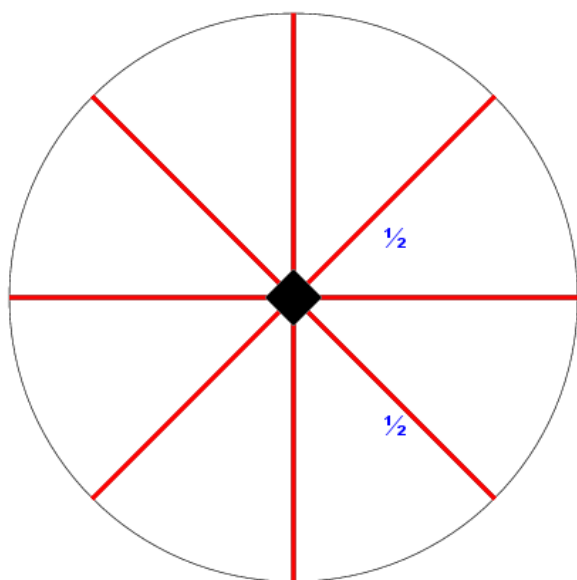

9.2.5.90

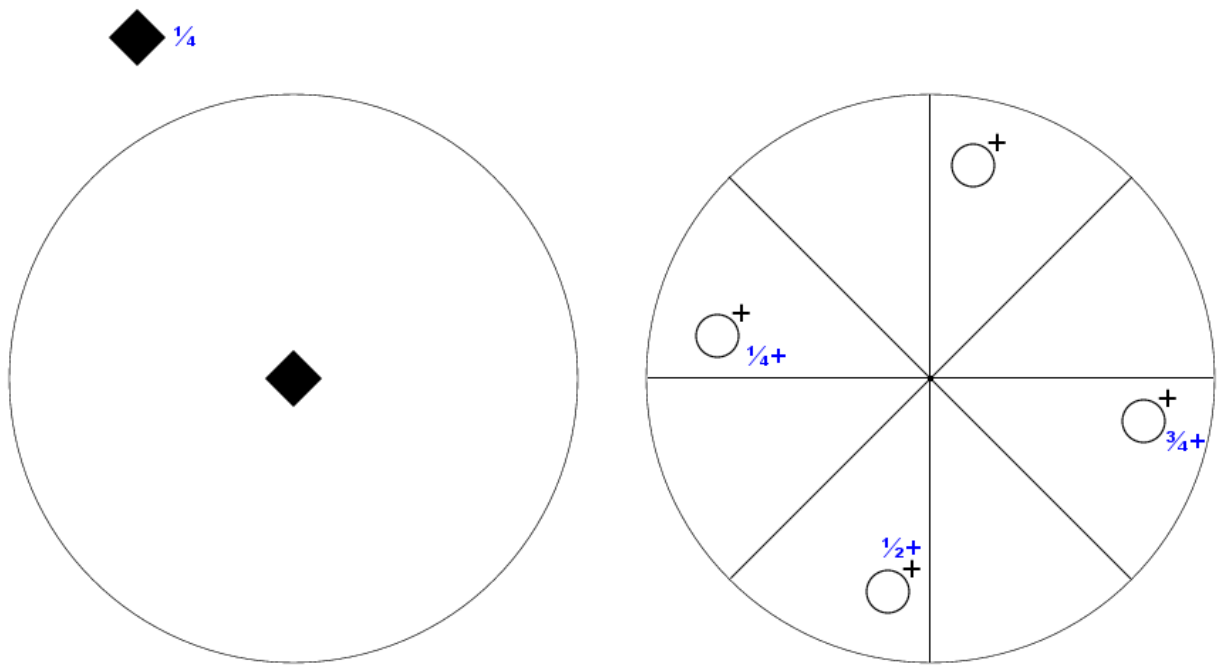

9.3.1.91

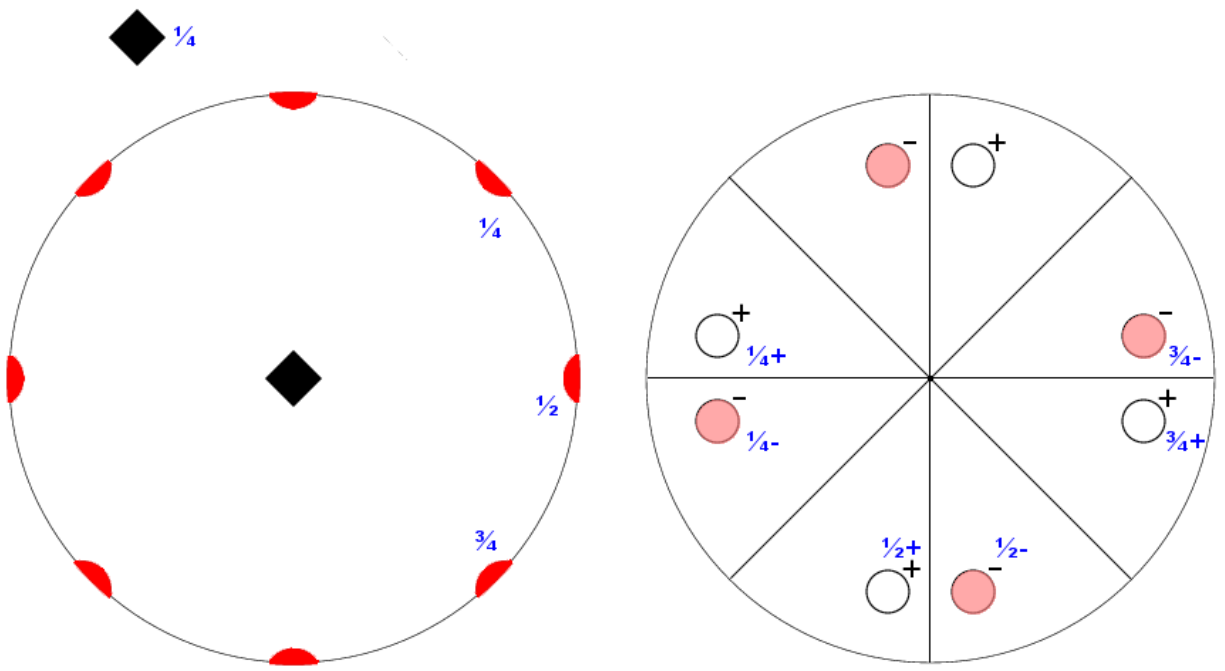

9.3.2.92

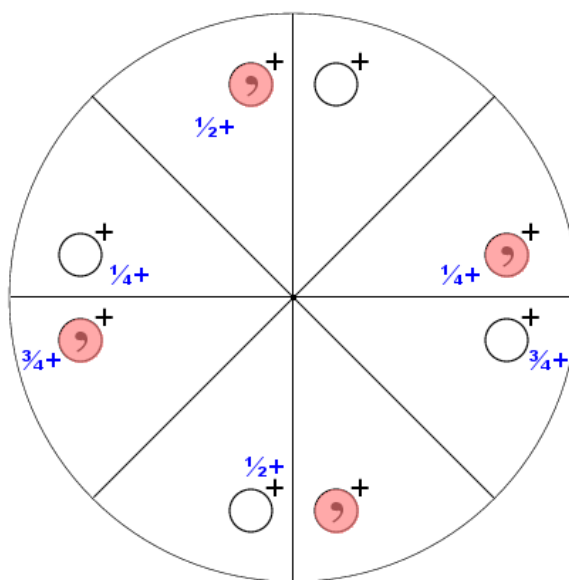
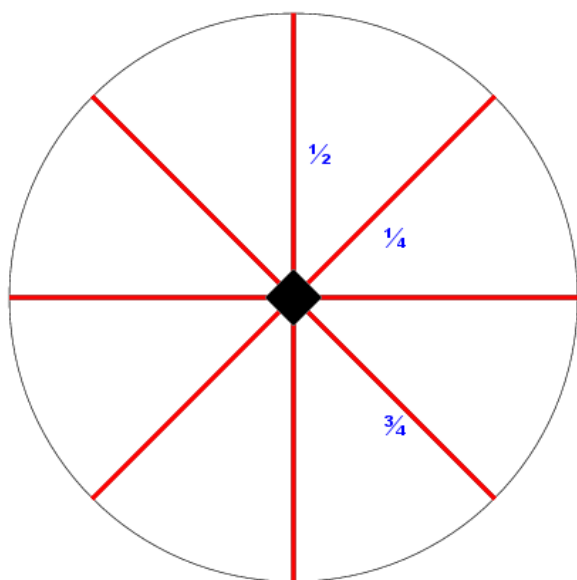

9.3.3.93

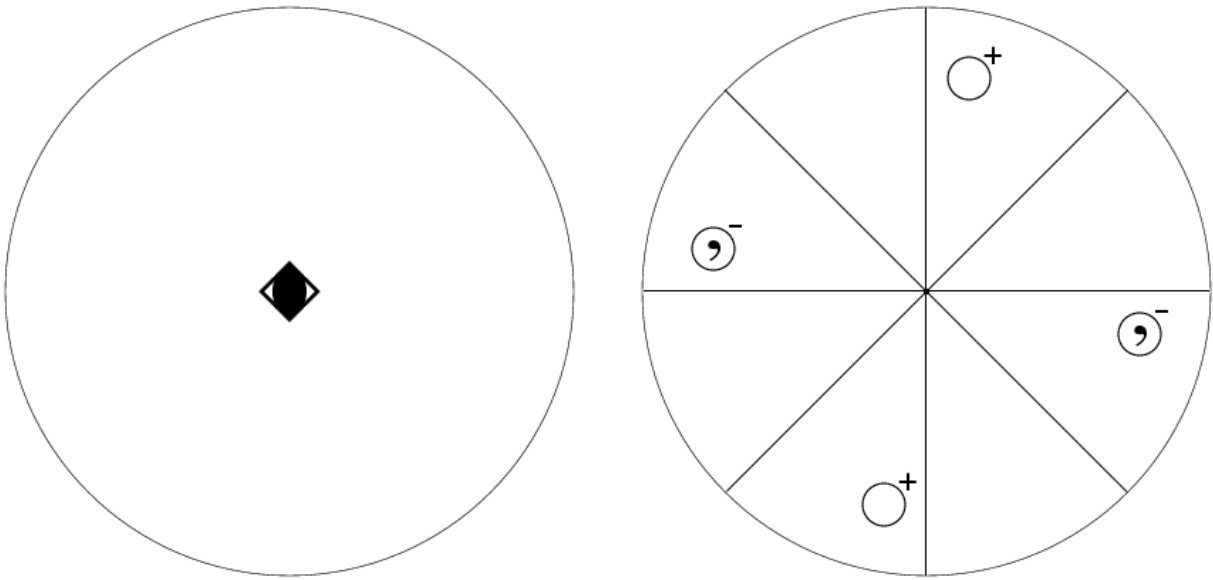

10.1.1.94

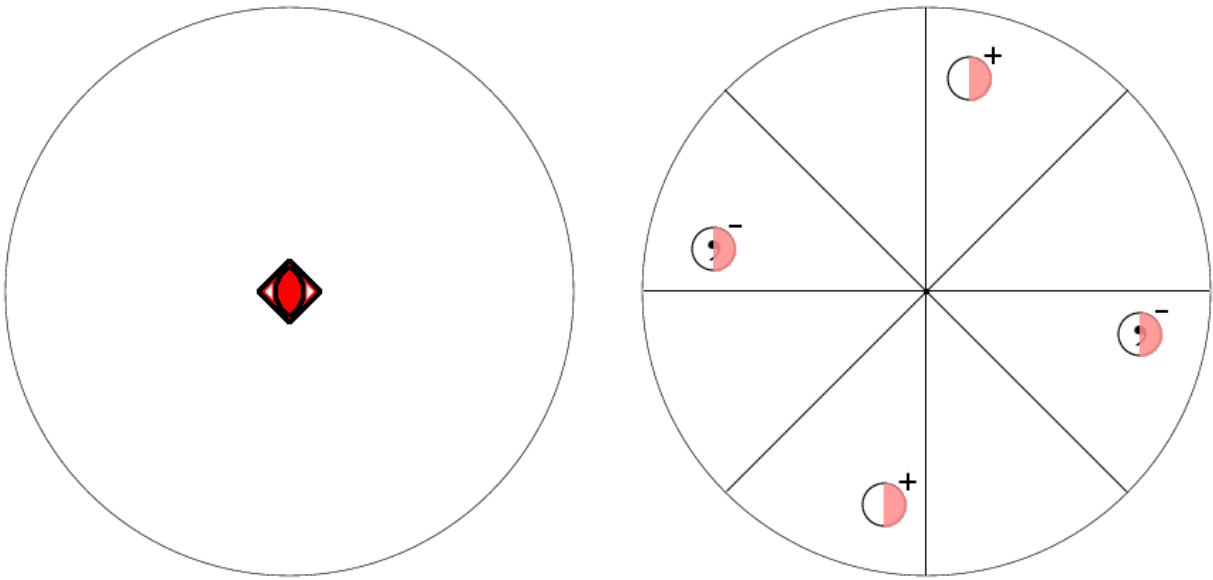

10.1.2.95

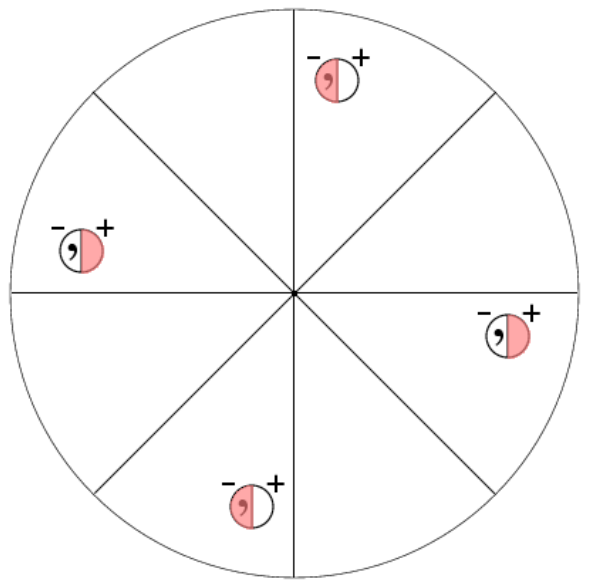
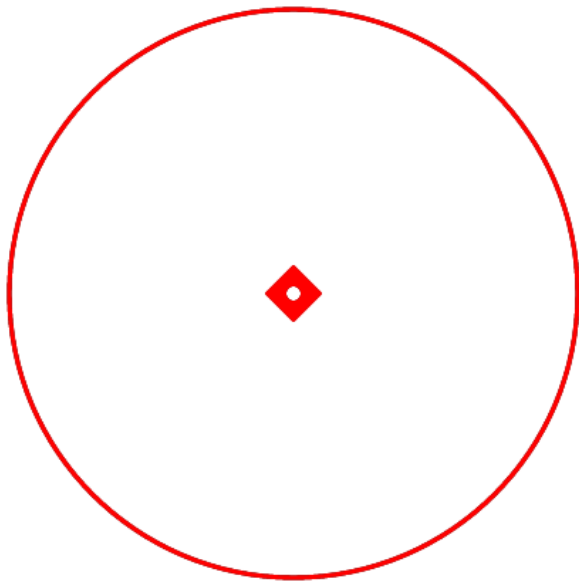

10.1.3.96

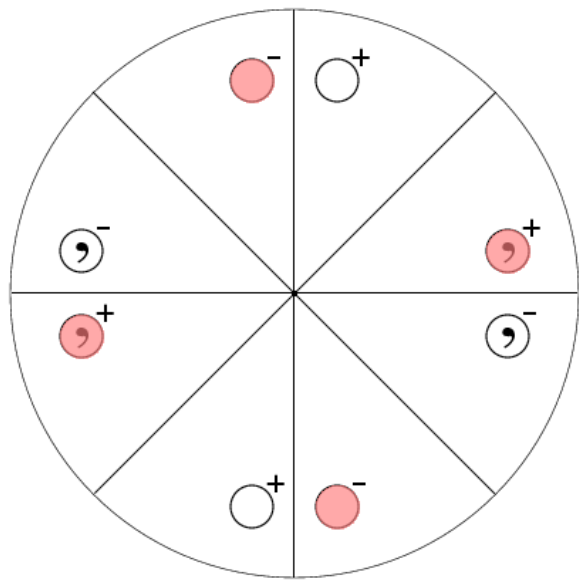
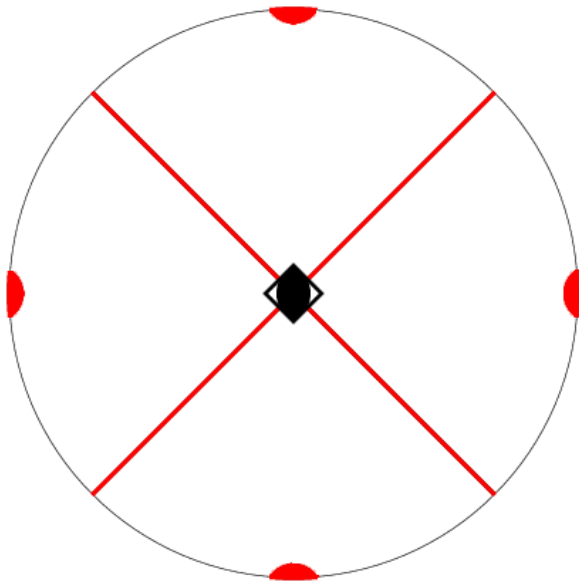

10.1.4.97

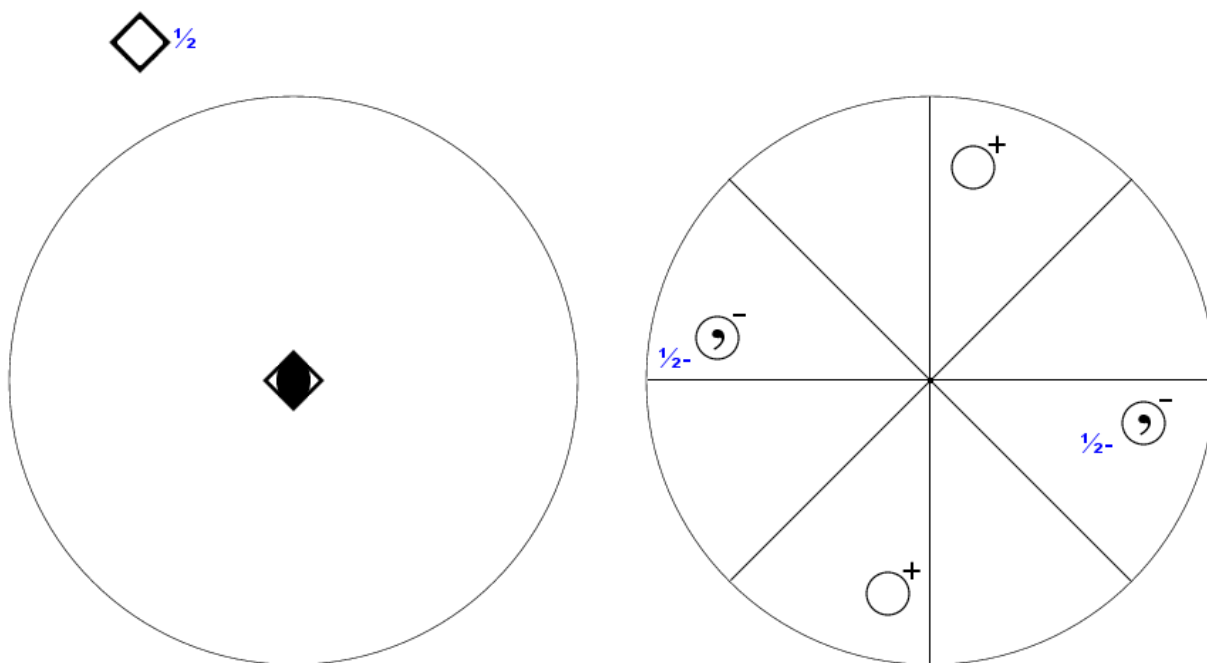

10.2.1.98

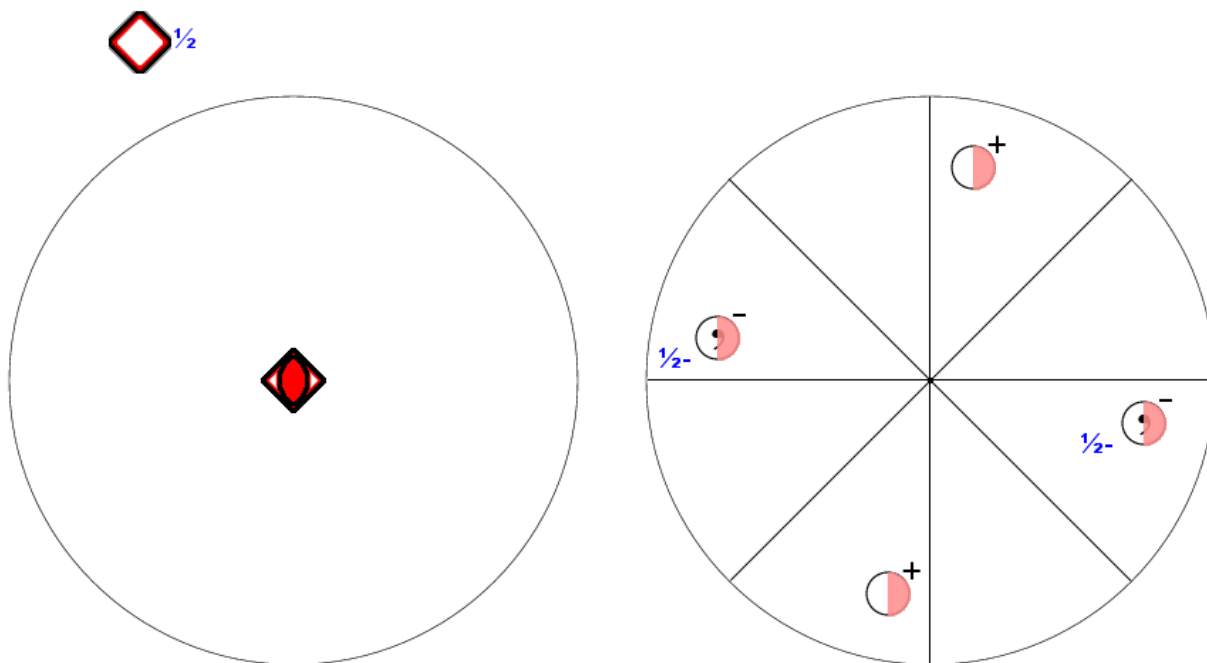

10.2.2.99

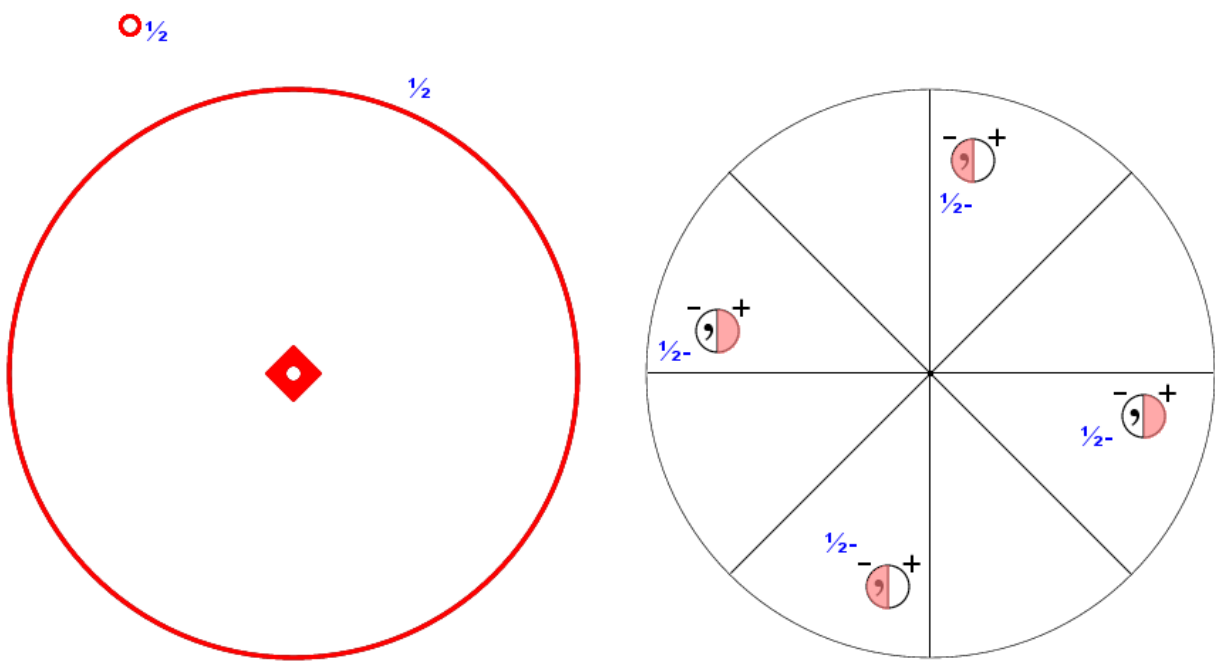

10.2.3.100

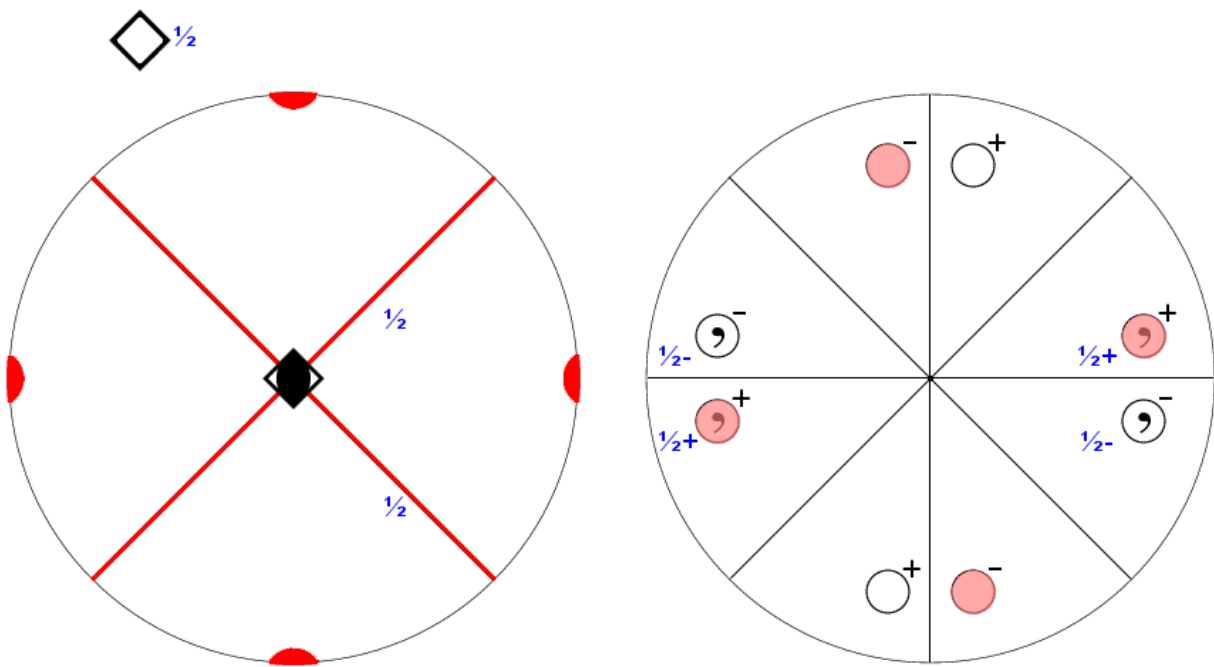

10.2.4.101

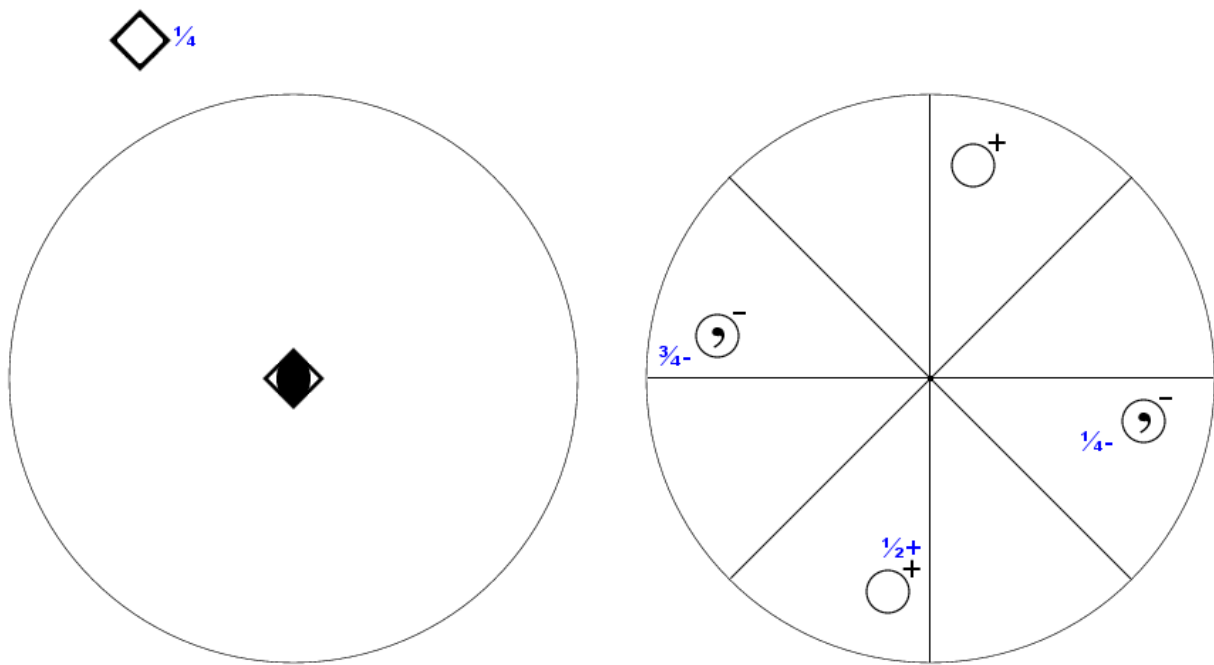

10.3.1.102

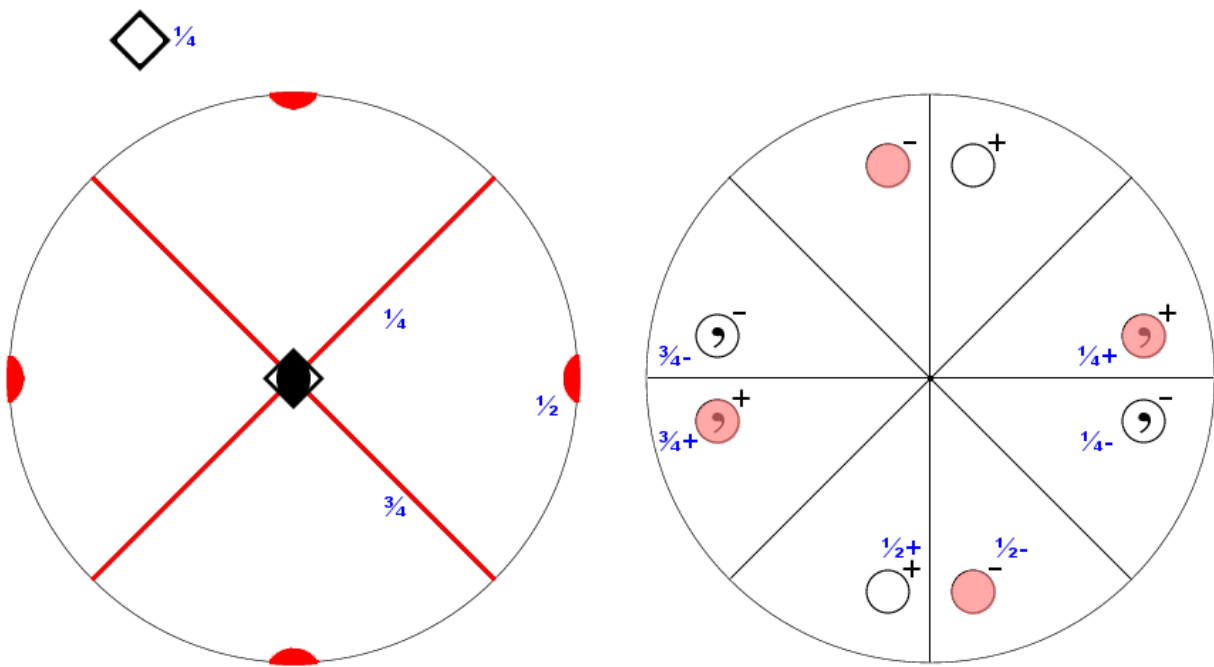

10.3.2.103

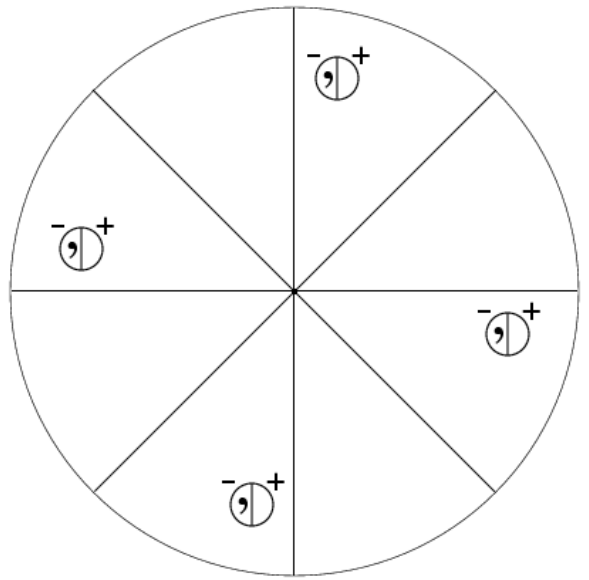
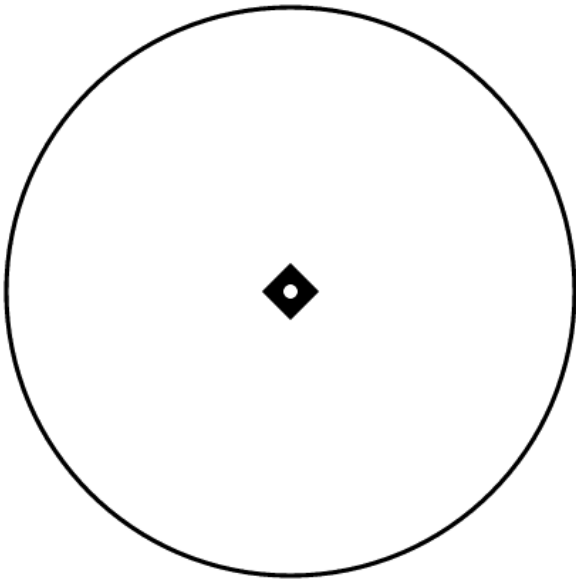

11.1.1.104

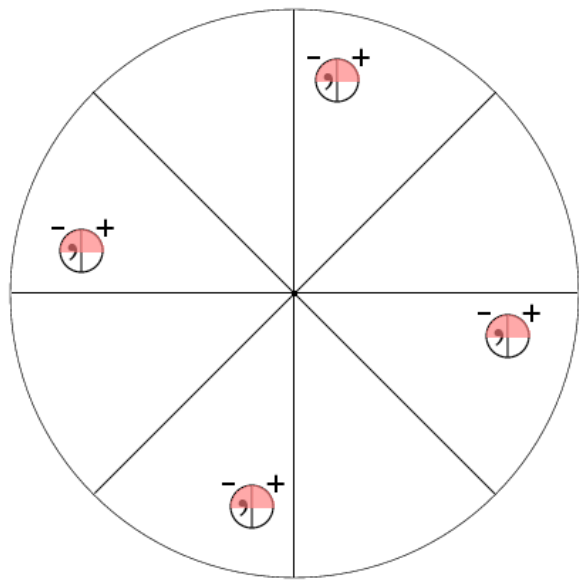
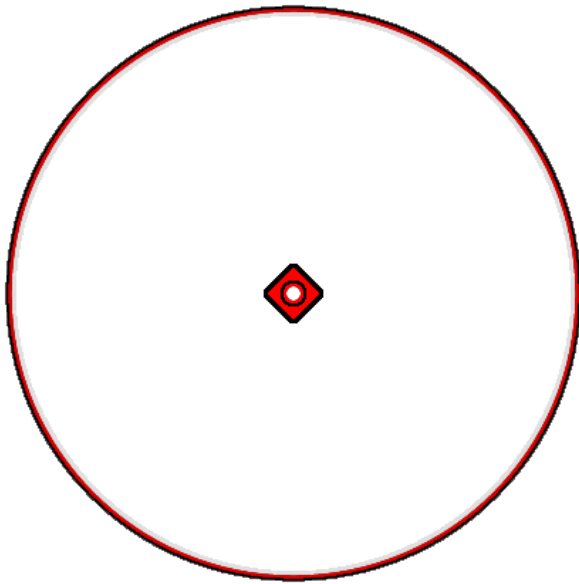

11.1.2.105

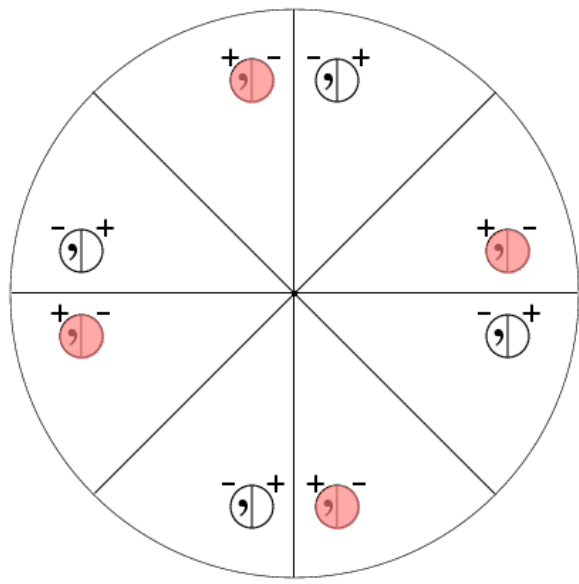
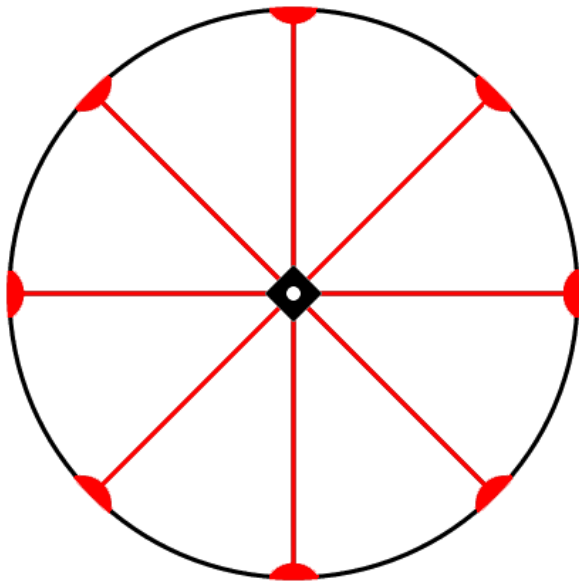

11.1.3.106

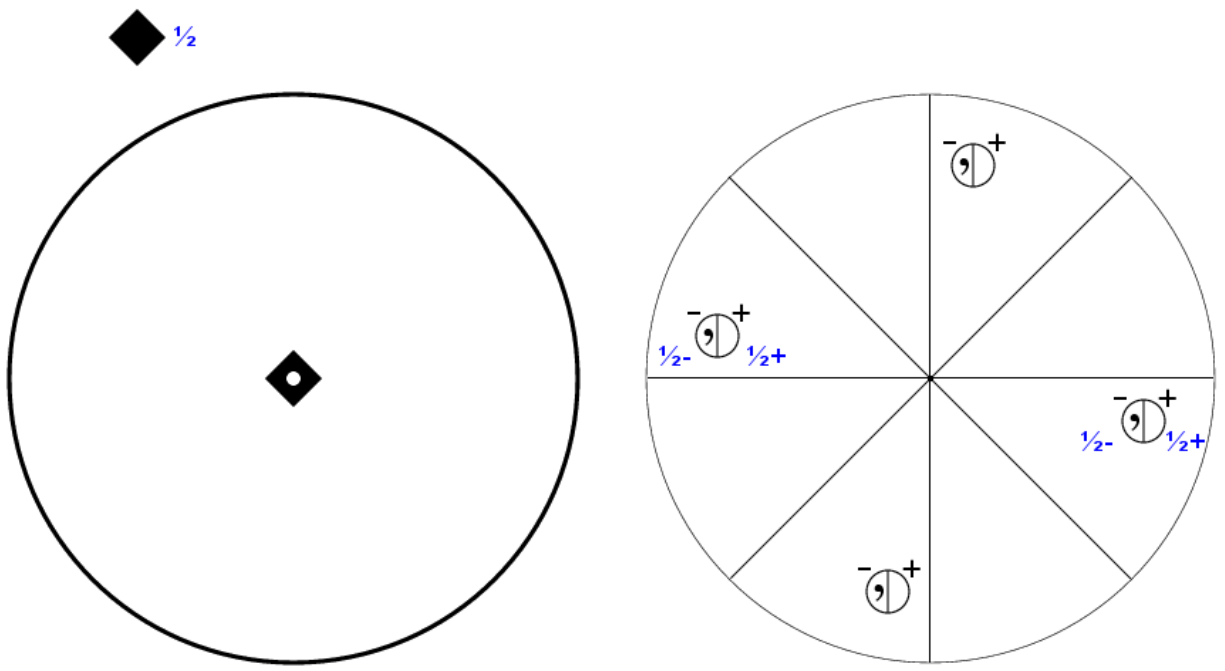

11.2.1.107

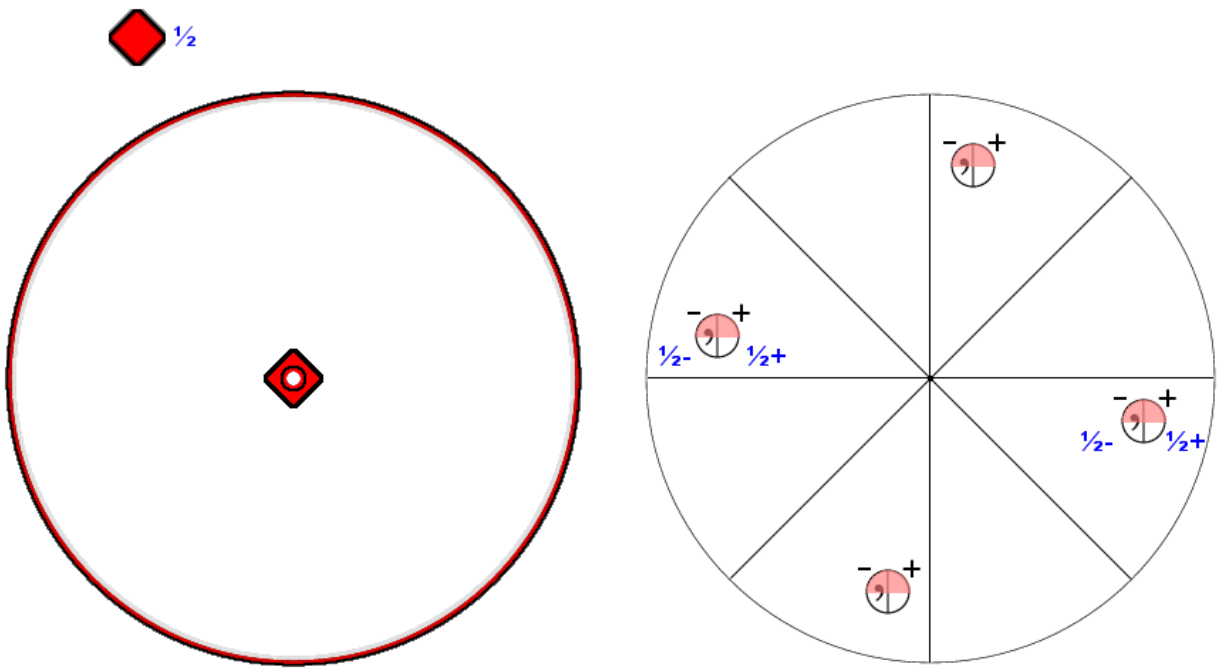

11.2.2.108

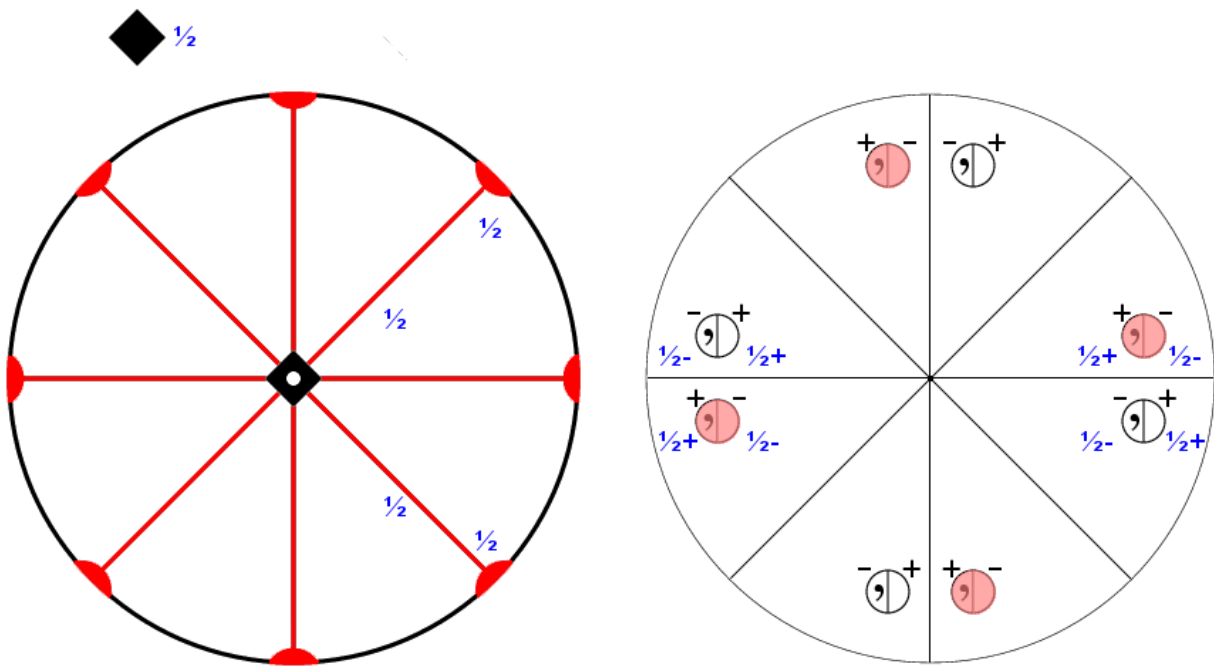

11.2.3.109

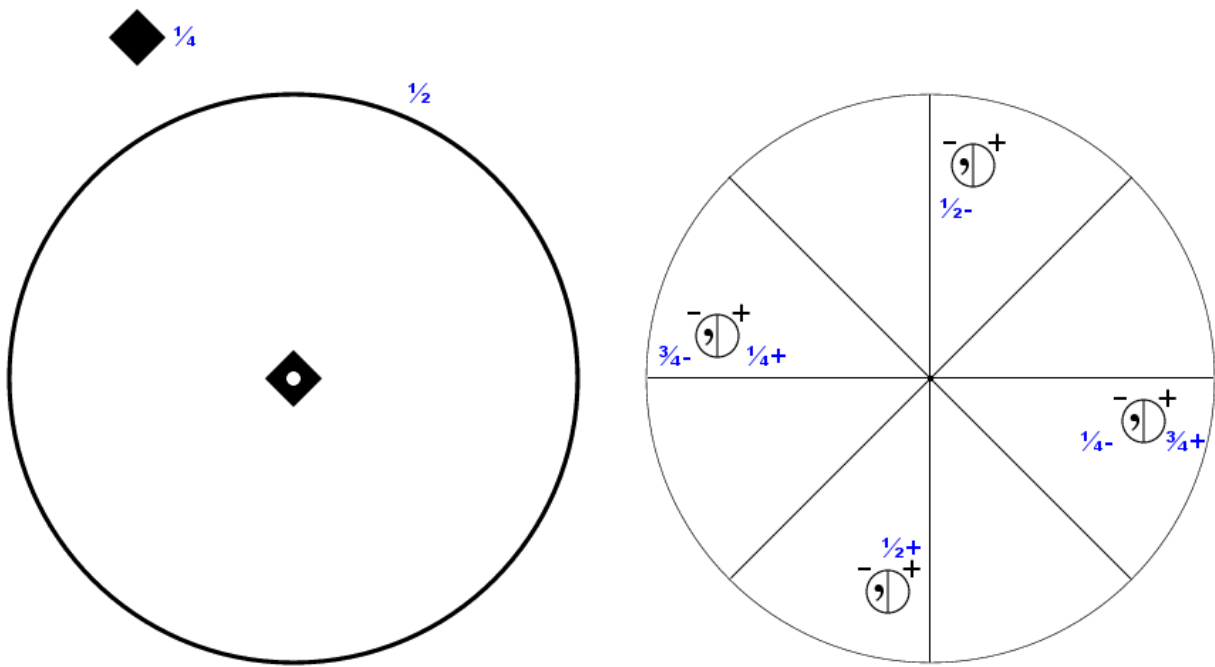

11.3.1.110

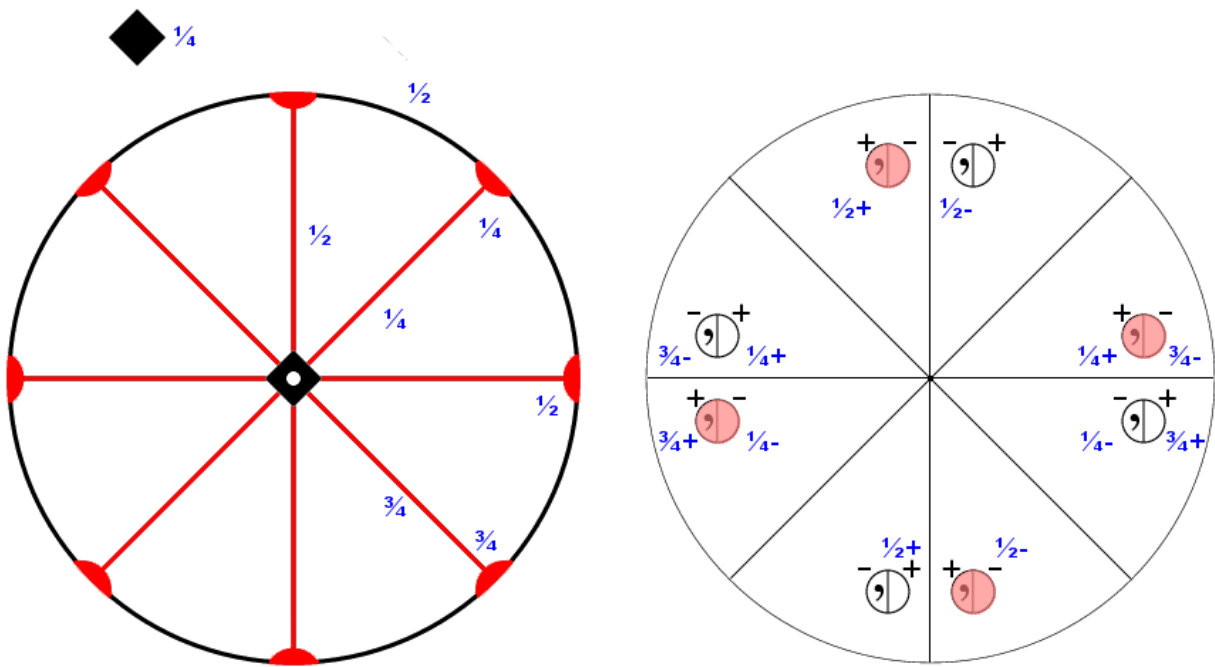

11.3.2.111

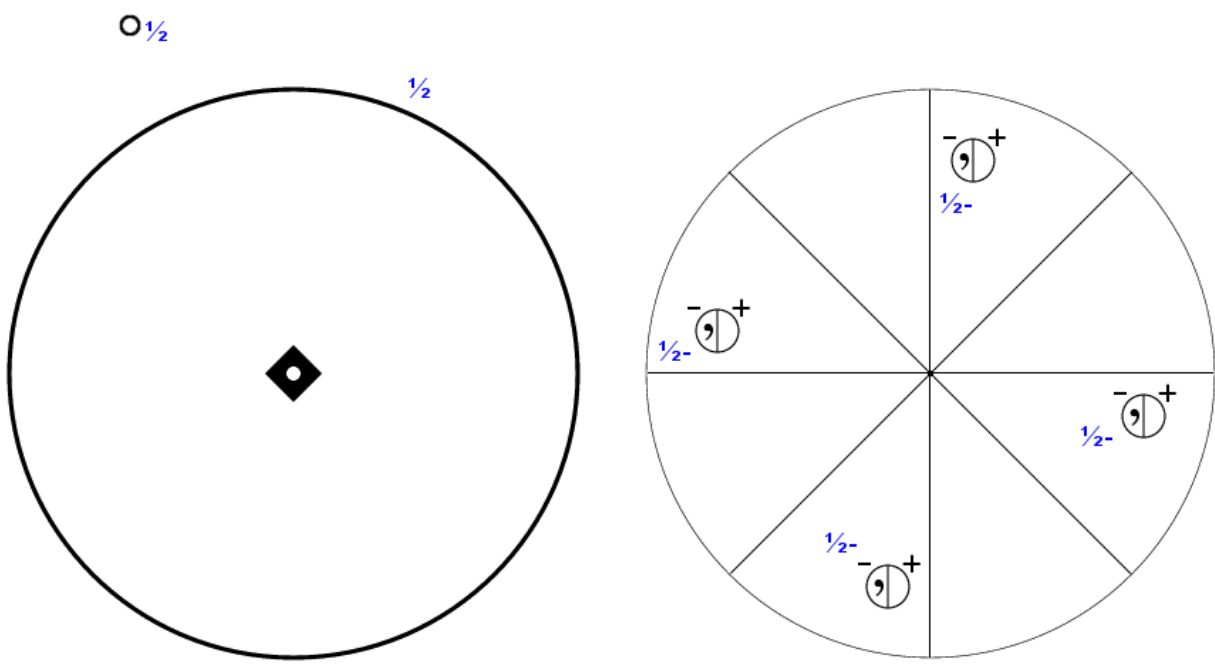

11.4.1.112

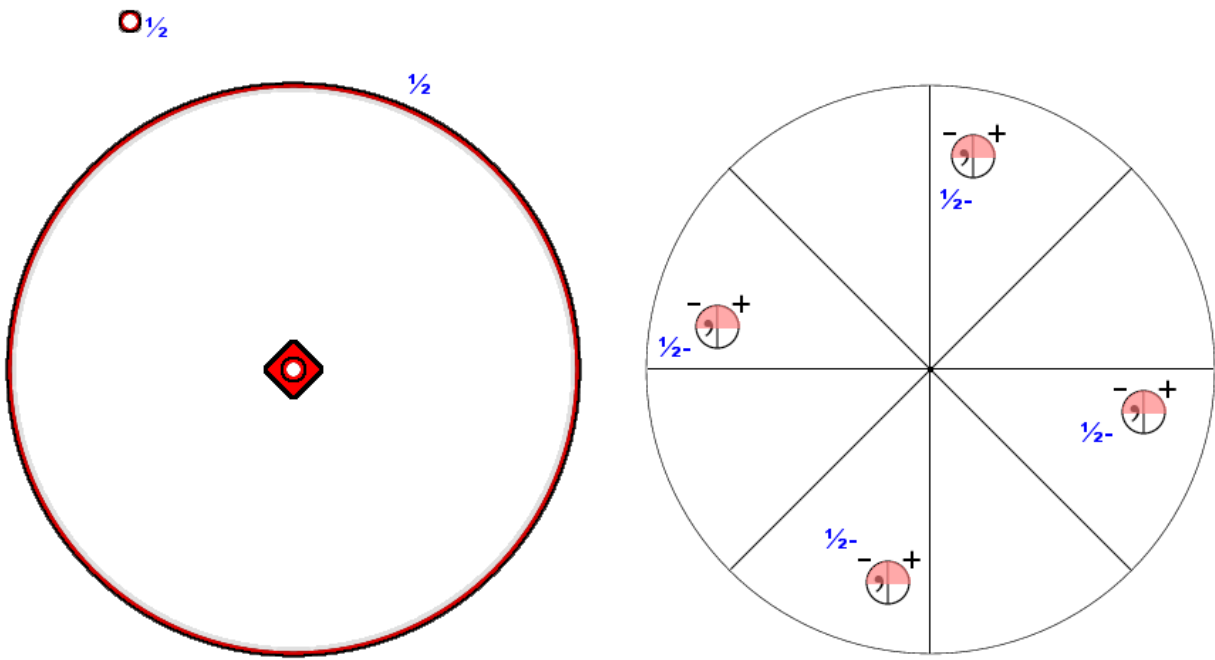

11.4.2.113

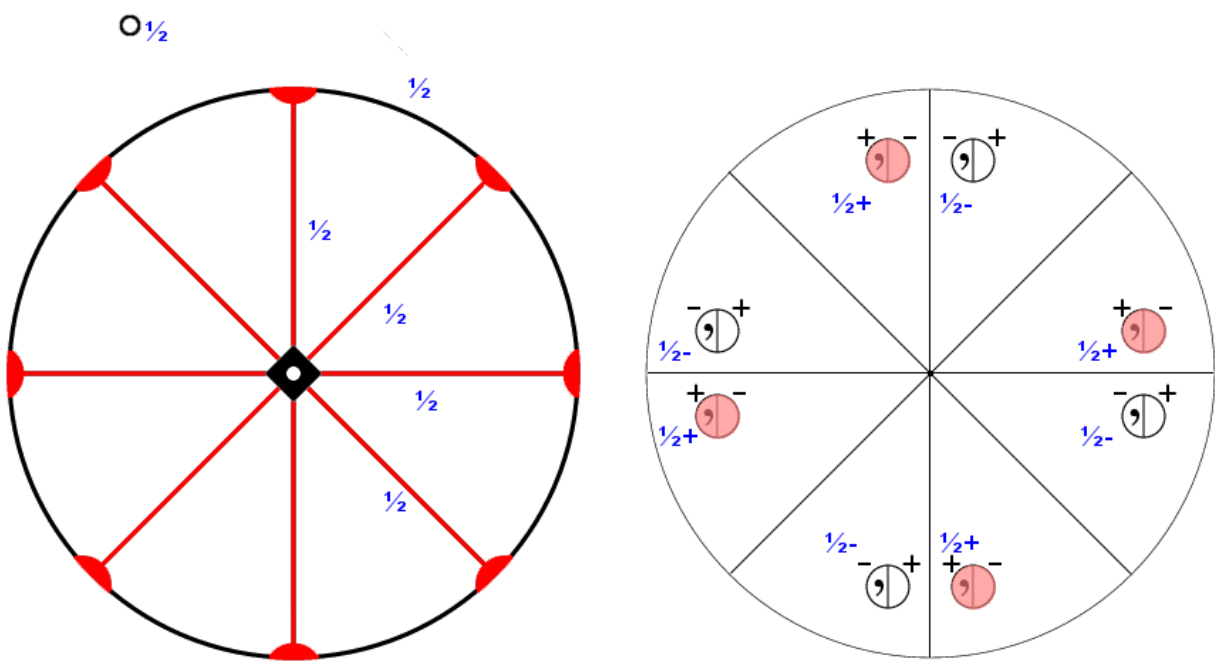

11.4.3.114

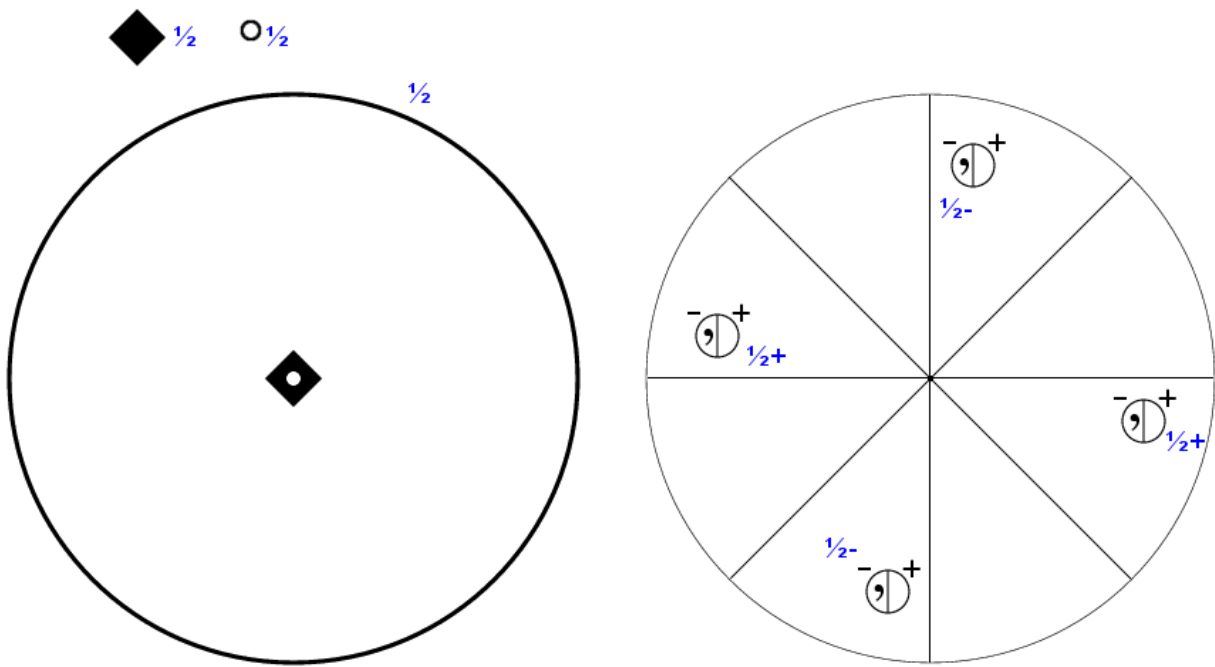

11.5.1.115

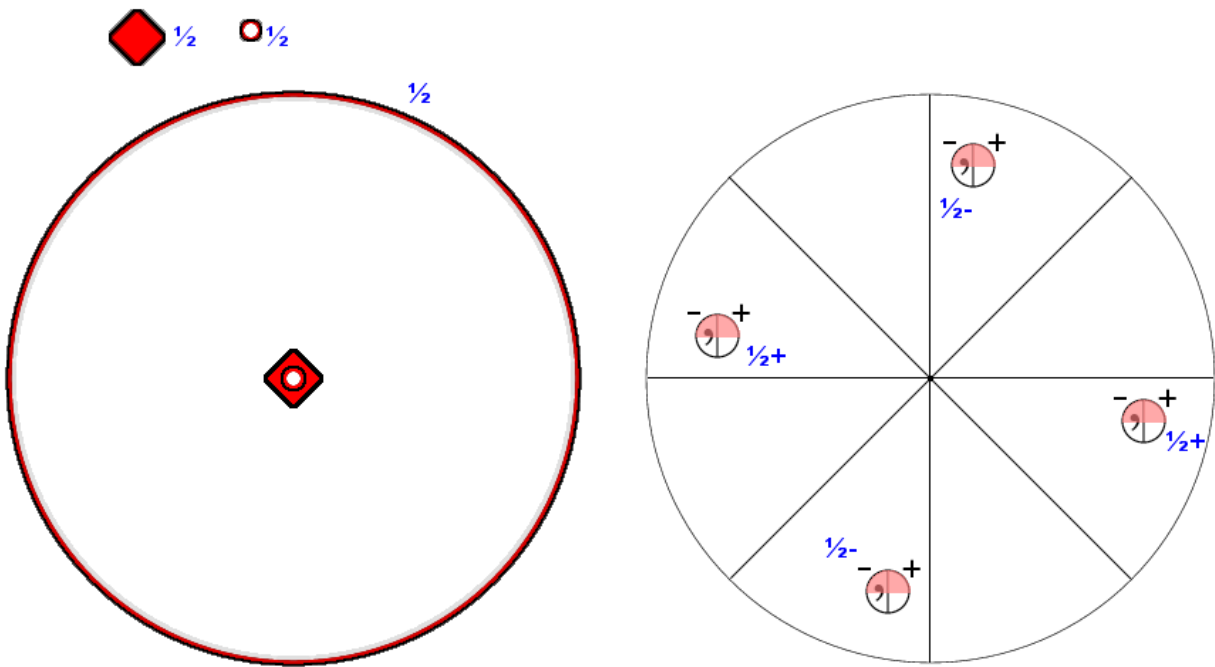

11.5.2.116

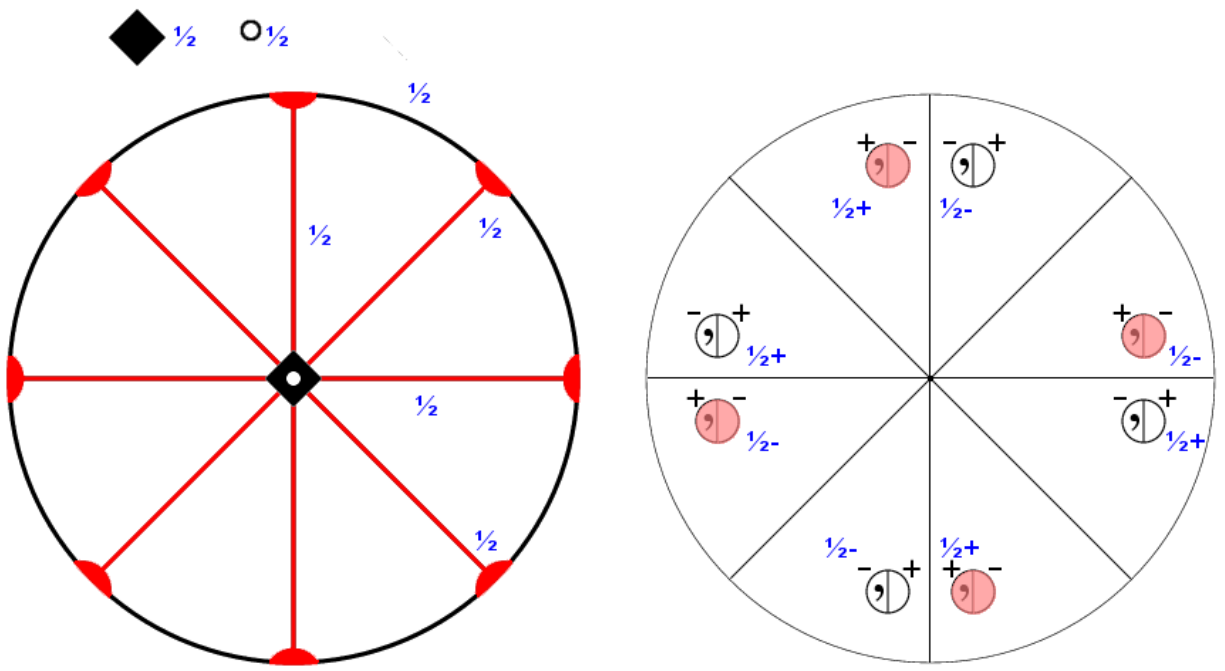

11.5.3.117

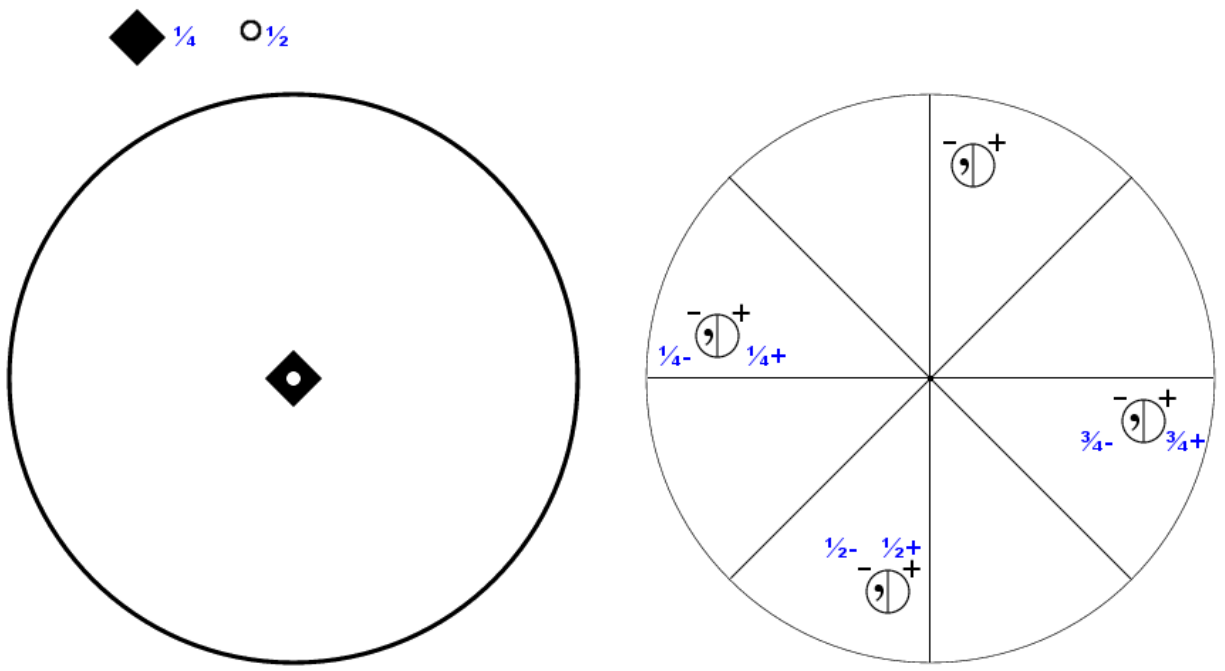

11.6.1.118

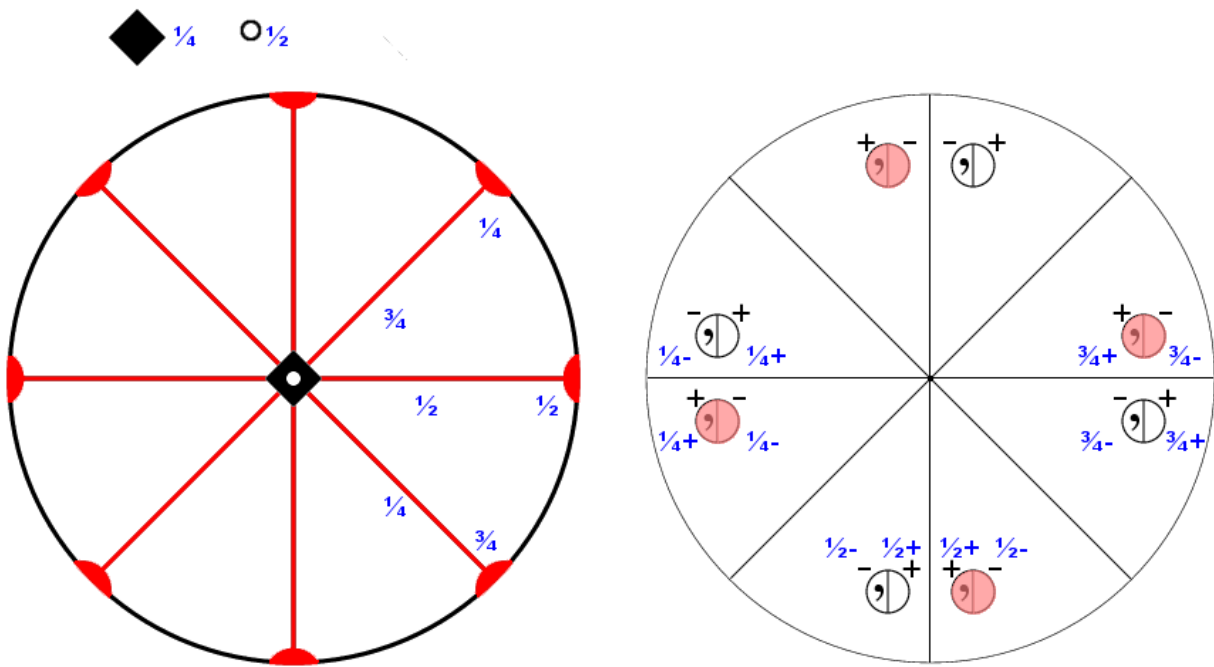

11.6.2.119

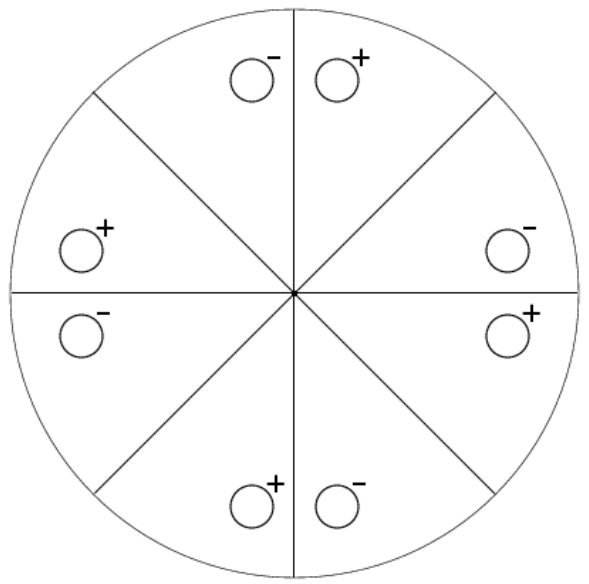
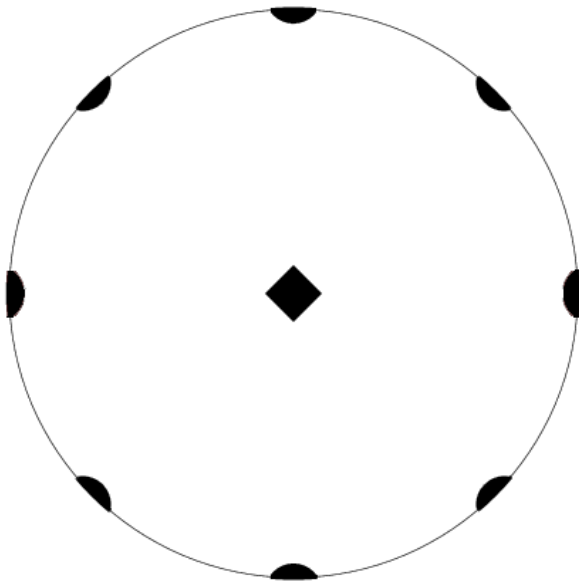

12.1.1.120

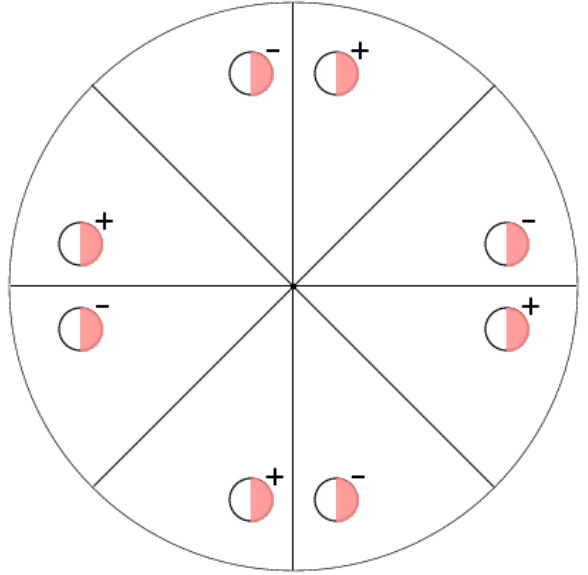
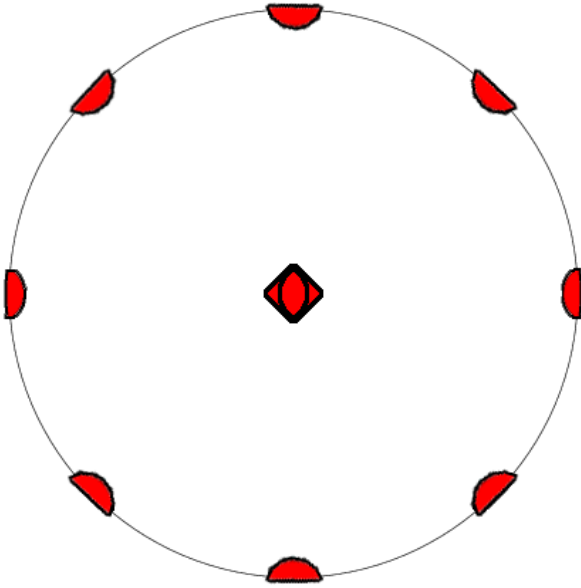

12.1.2.121

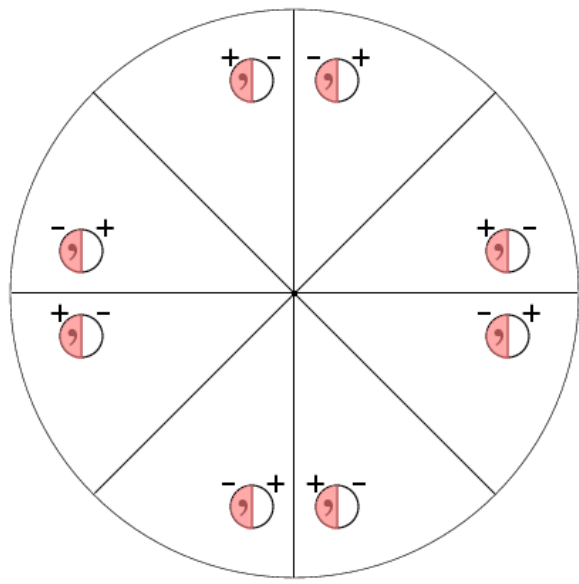
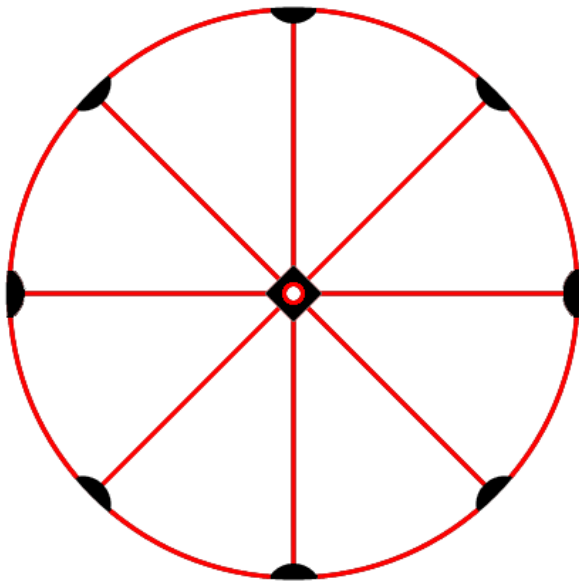

12.1.3.122

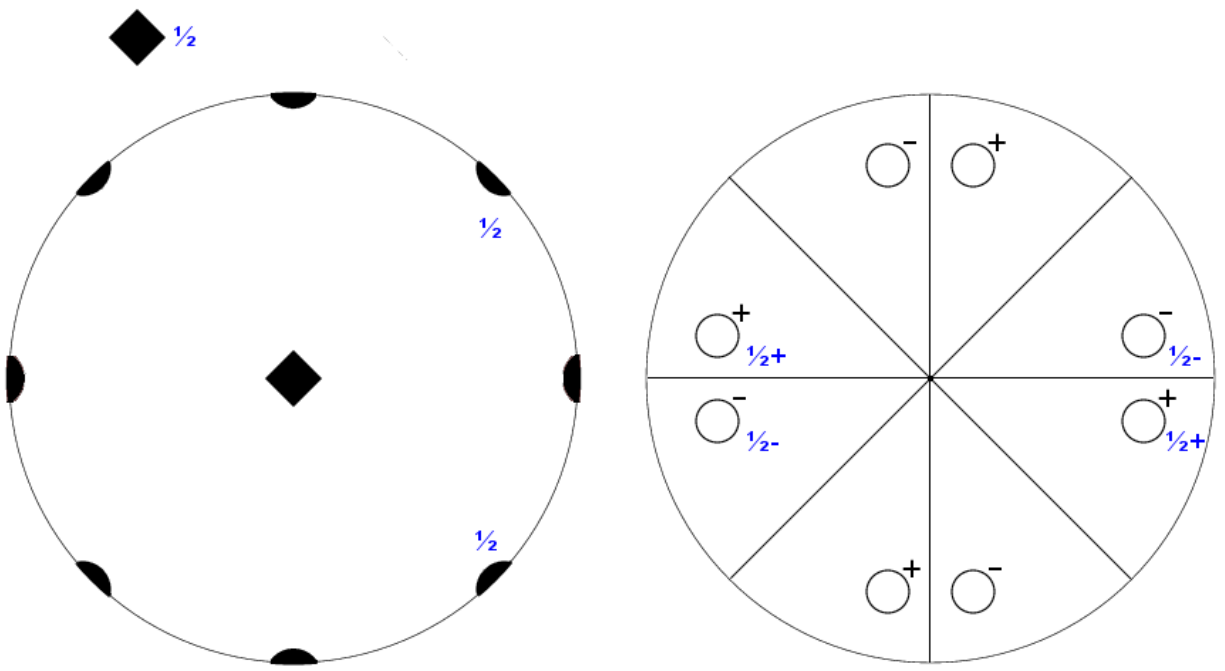

12.2.1.123

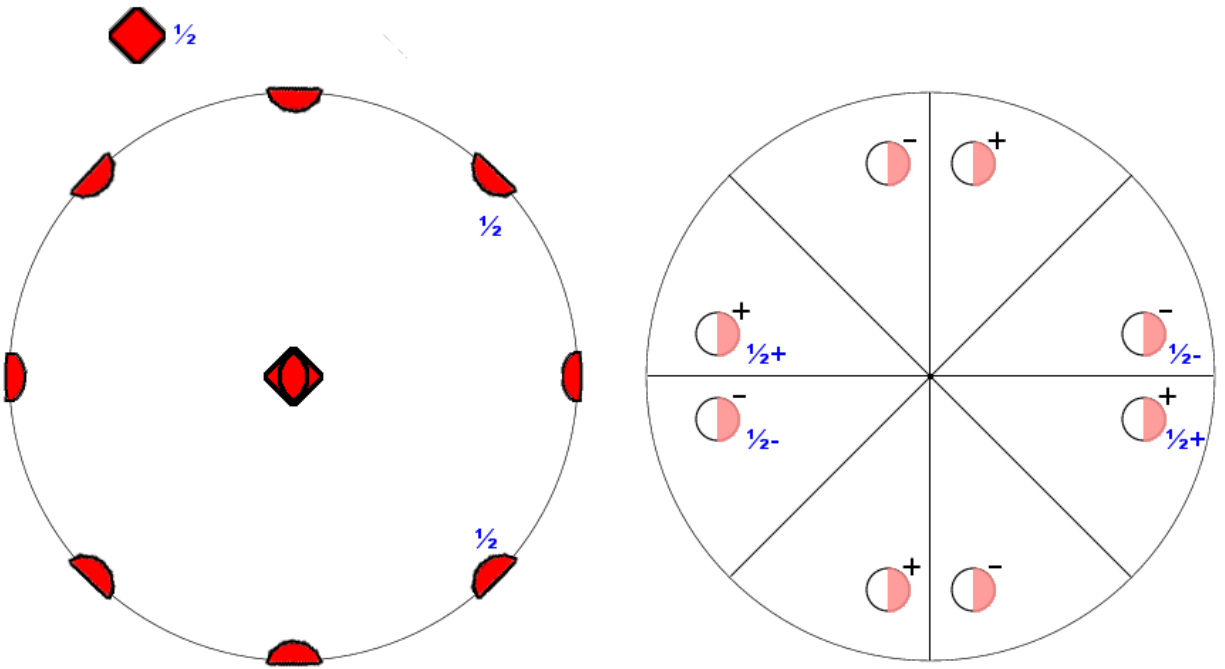

12.2.2.124

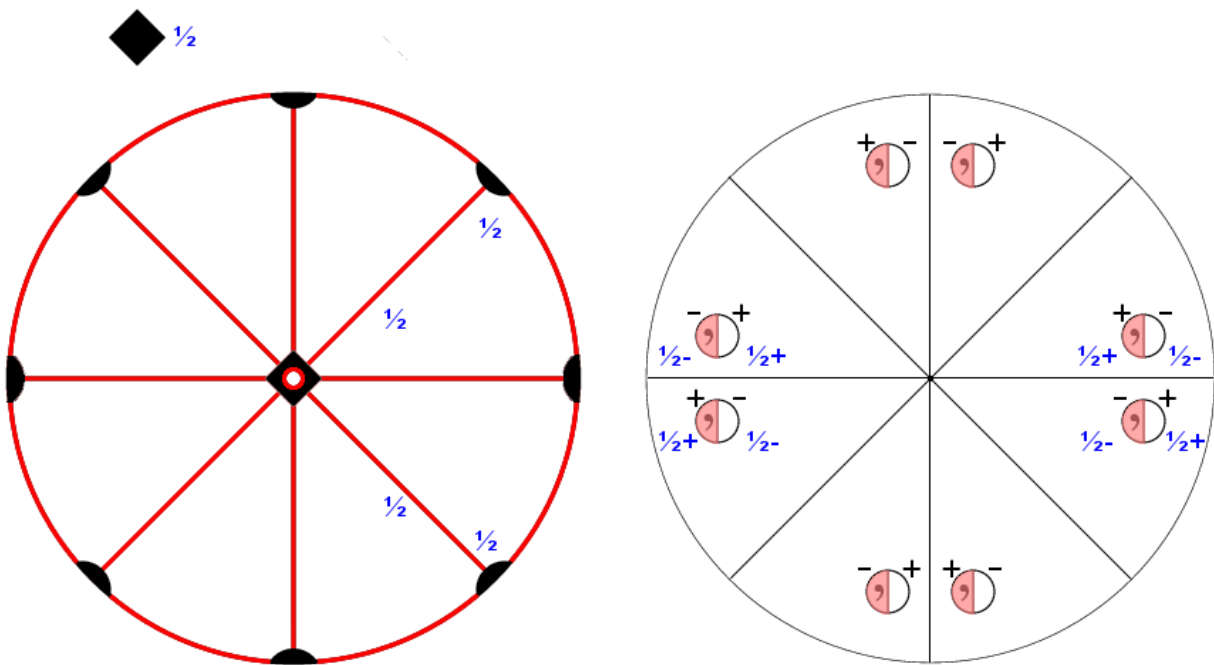

12.2.3.125

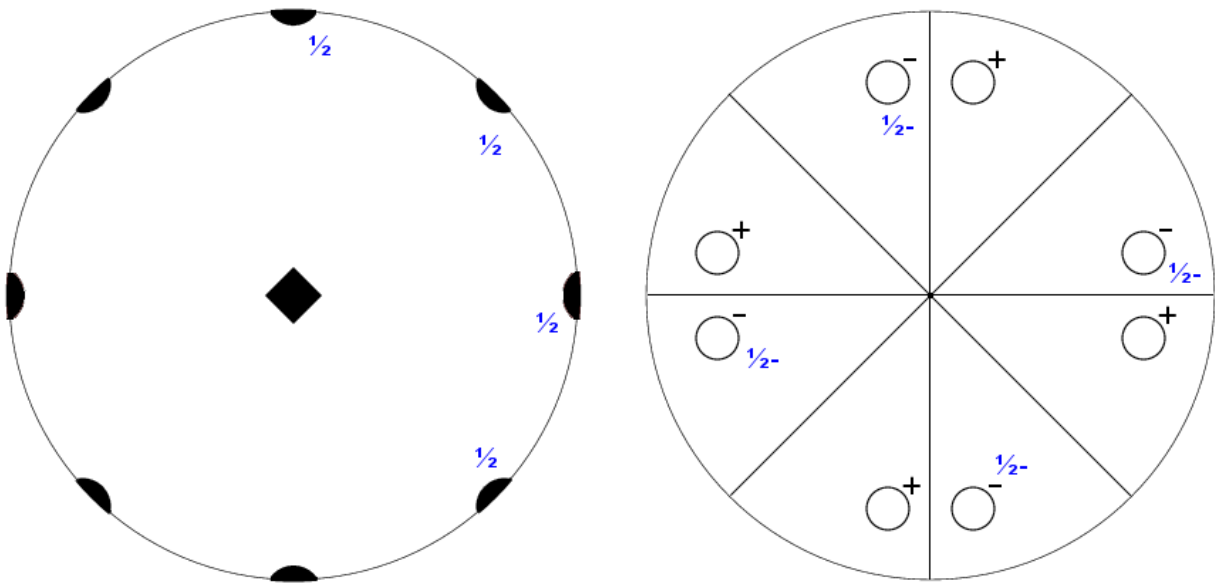

12.3.1.126

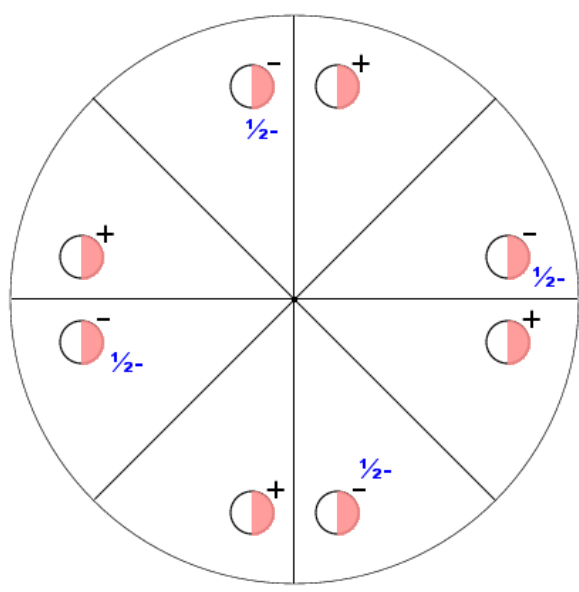
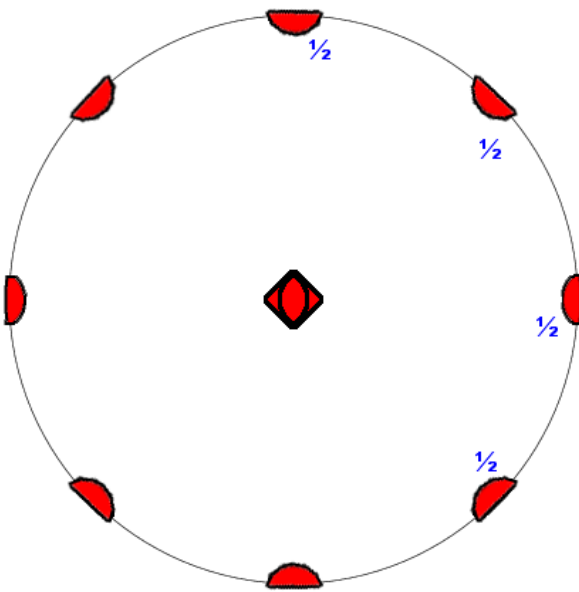

12.3.2.127

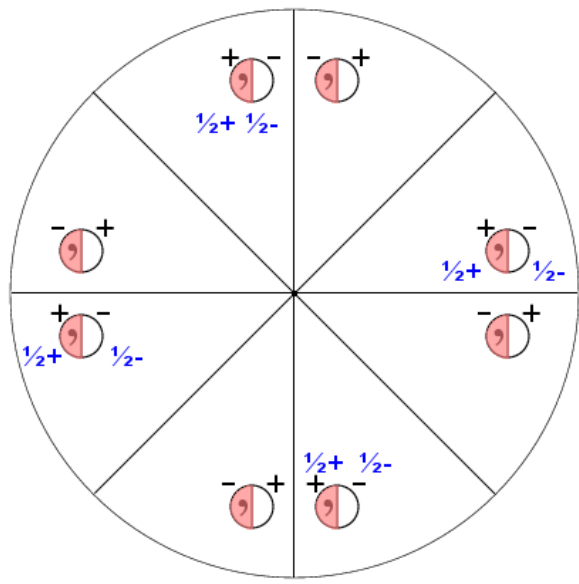
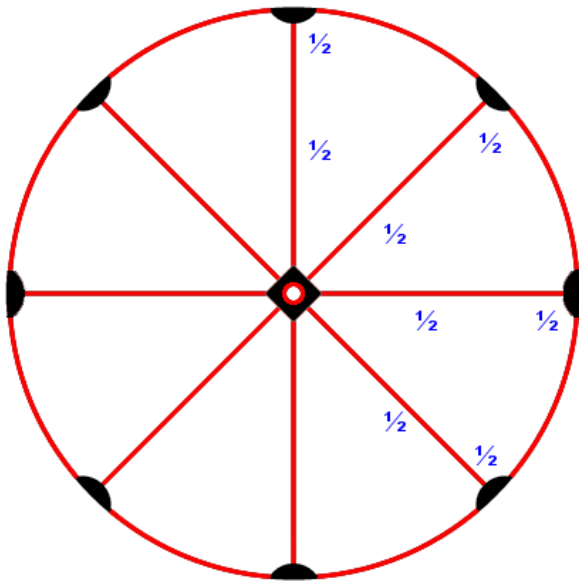

12.3.3.128

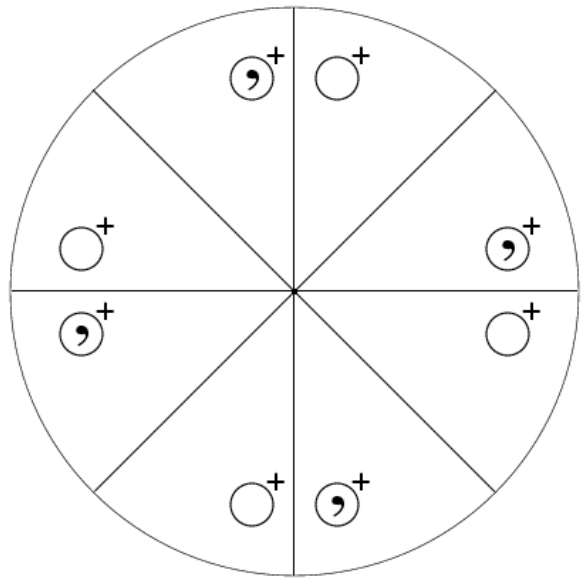
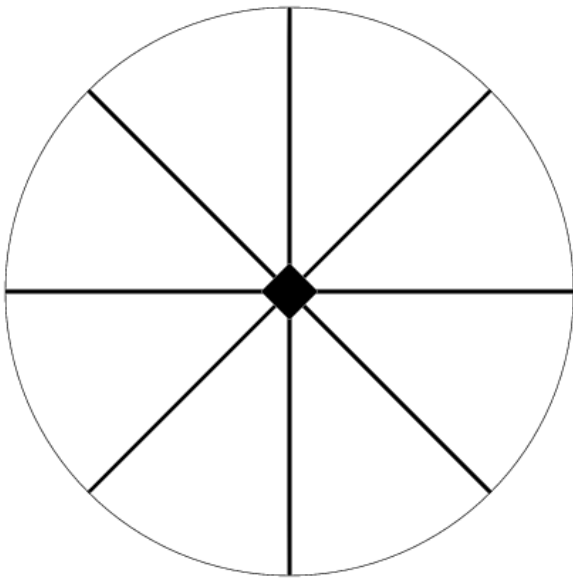

13.1.1.129

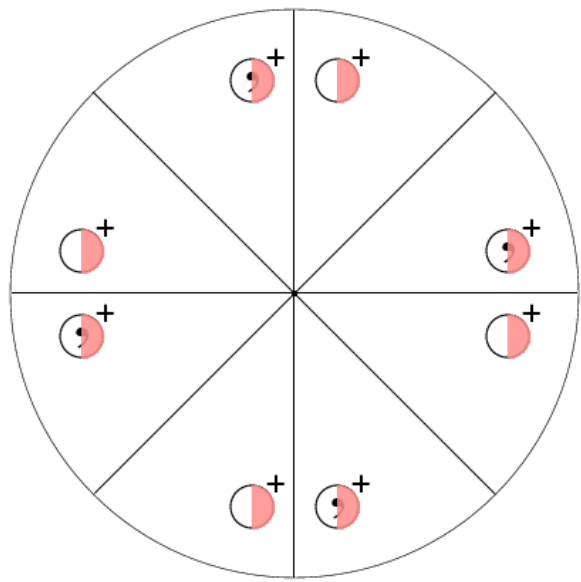
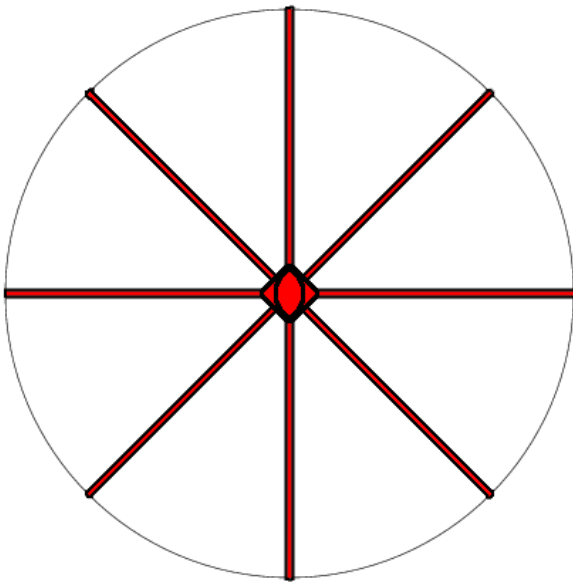

13.1.2.130

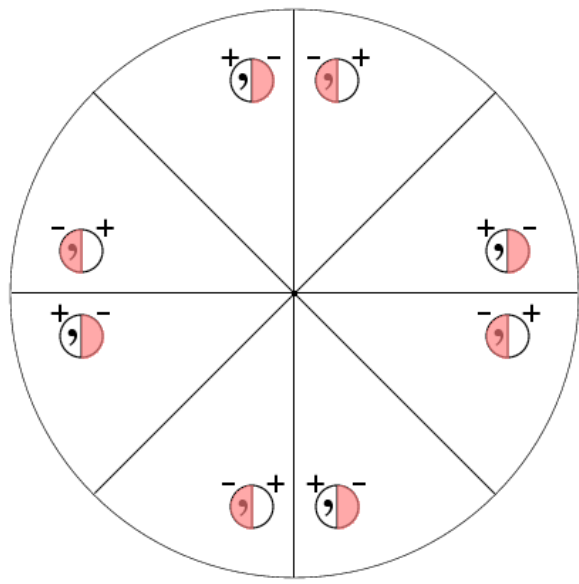
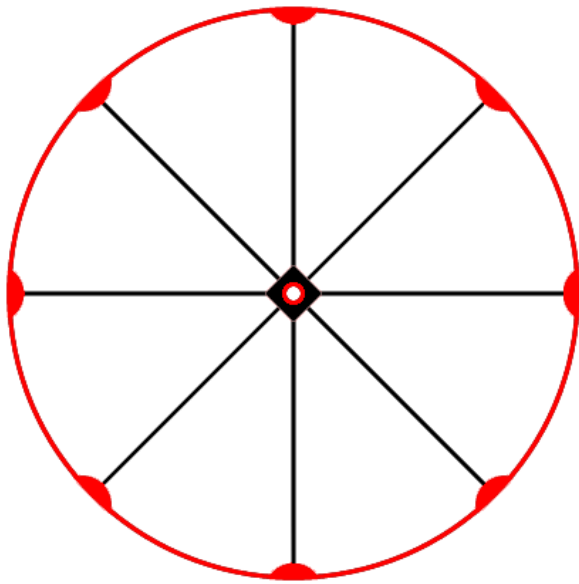

13.1.3.131

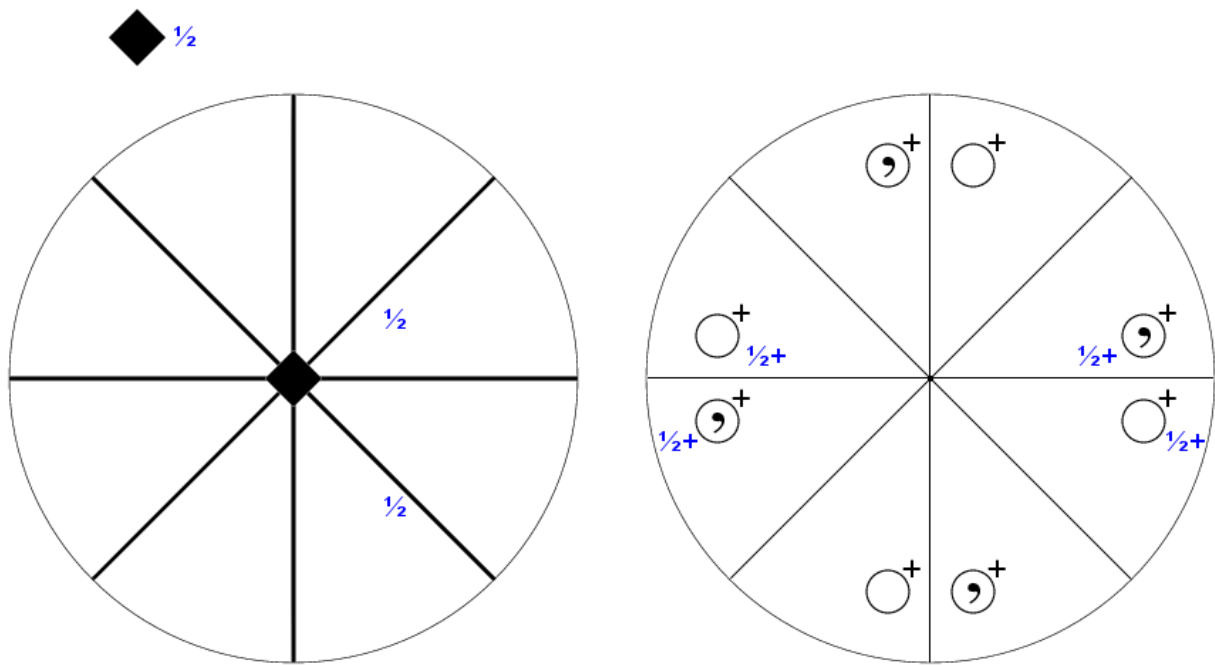

13.2.1.132

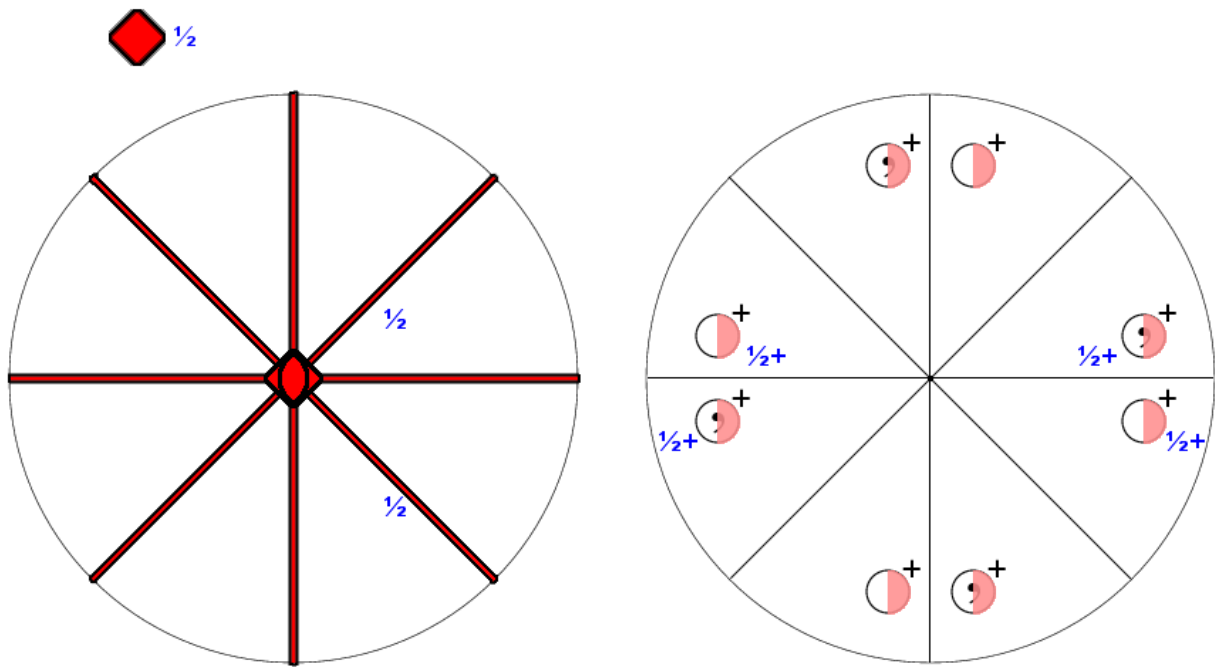

13.2.2.133

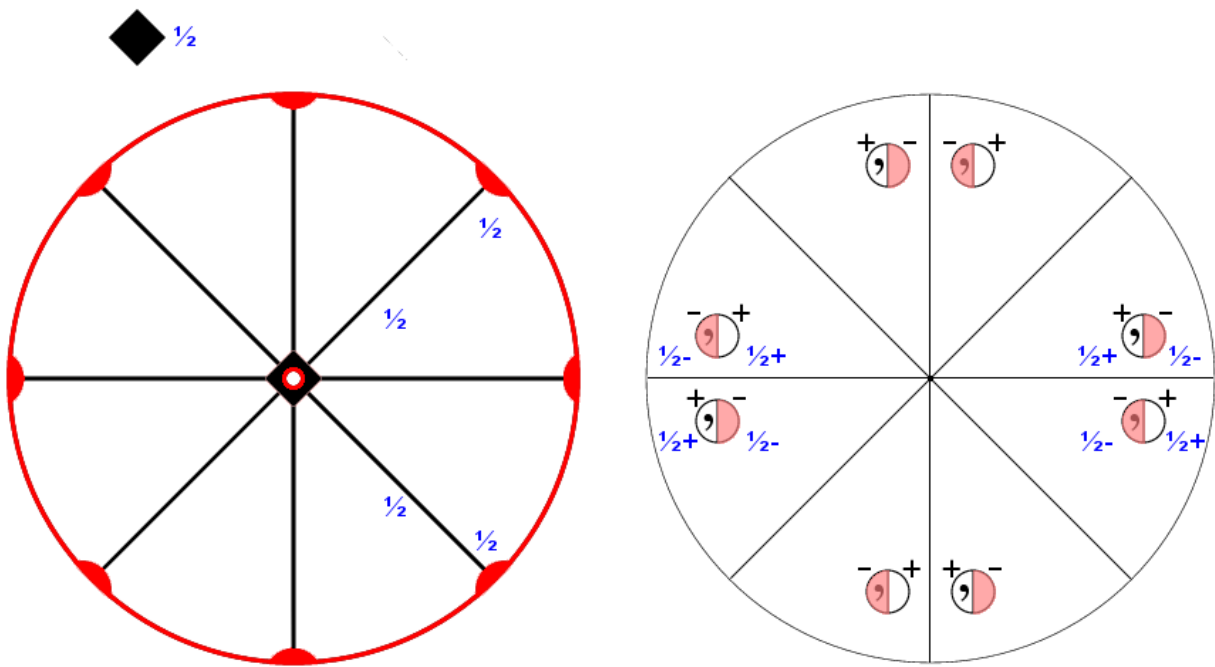

13.2.3.134

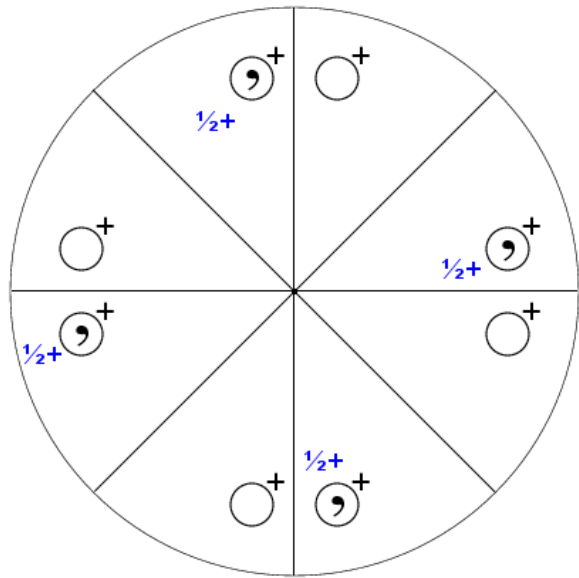
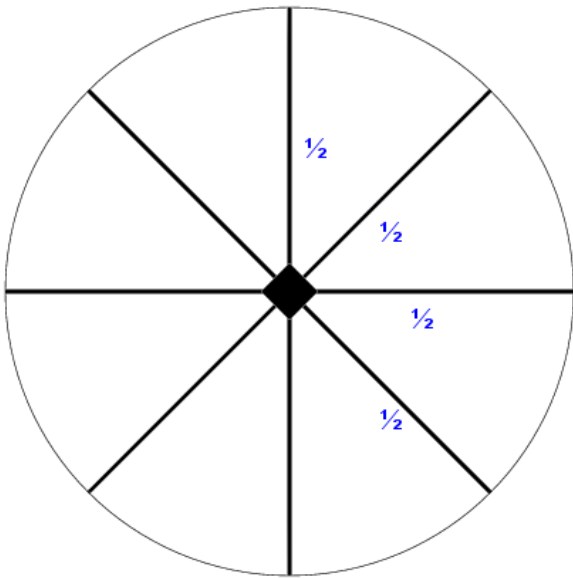

13.3.1.135

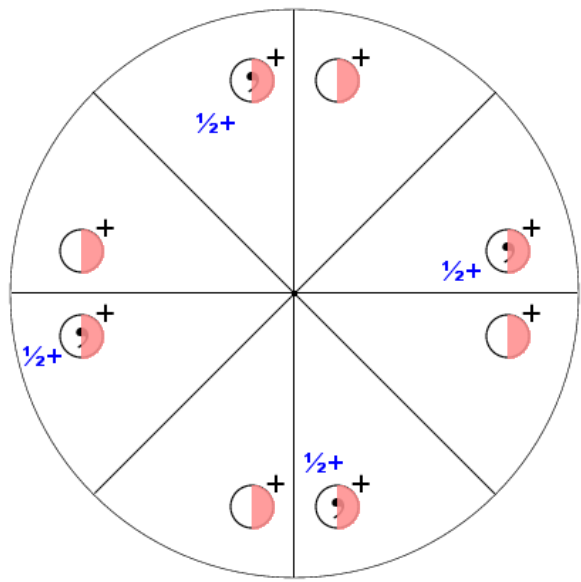
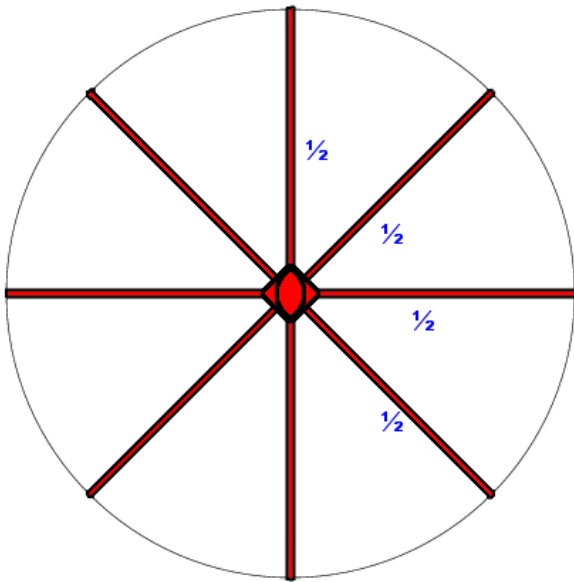

13.3.2.136

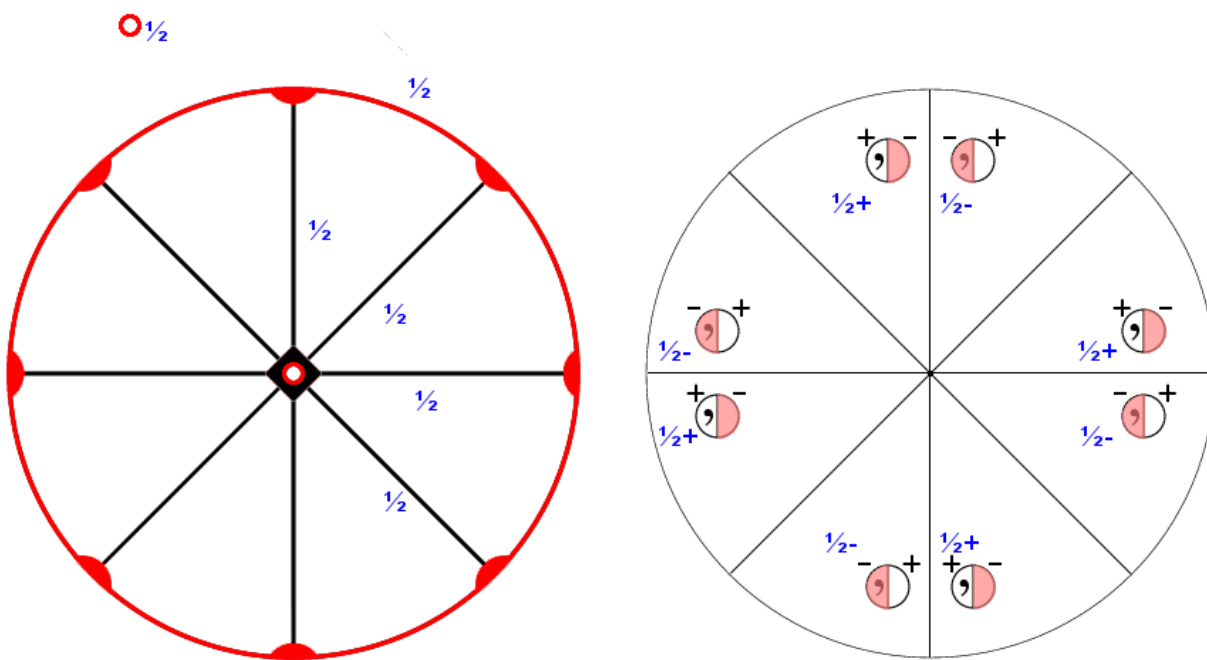

13.3.3.137

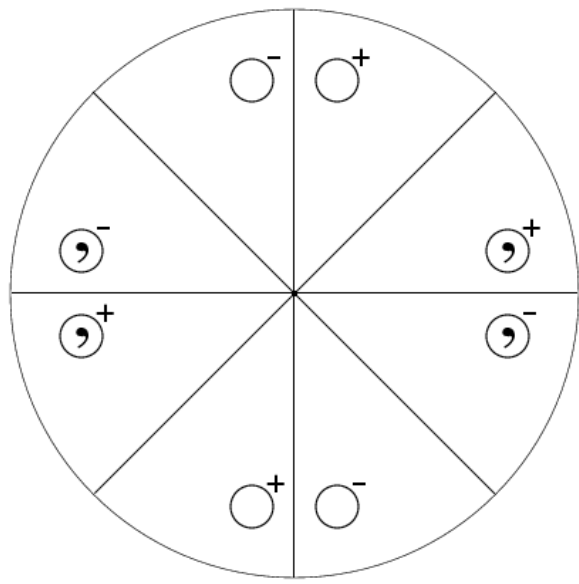
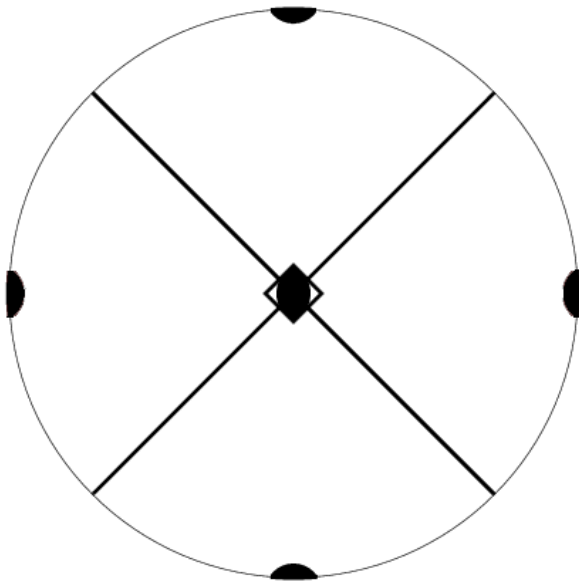

14.1.1.138

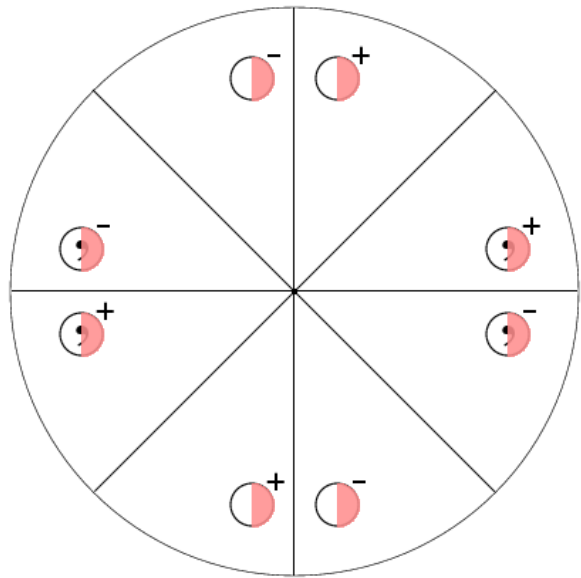
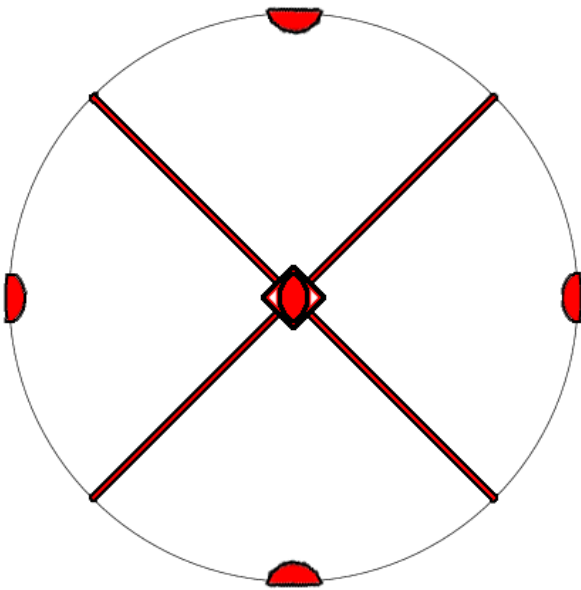

14.1.2.139

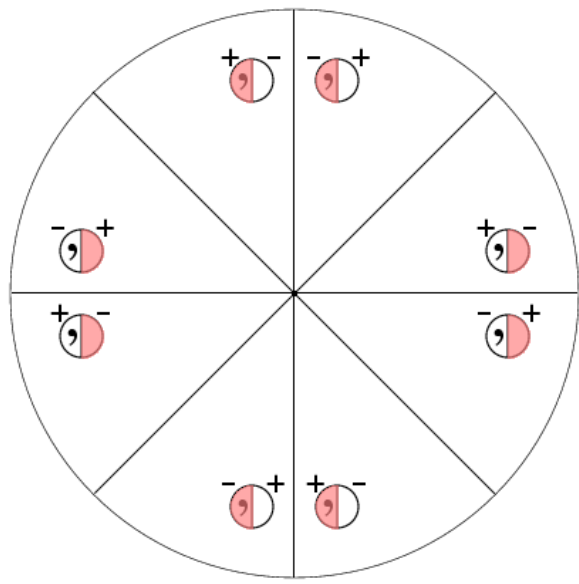
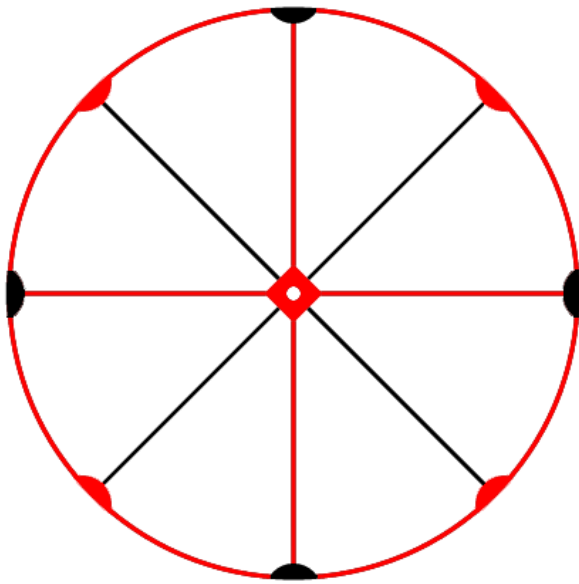

14.1.3.140

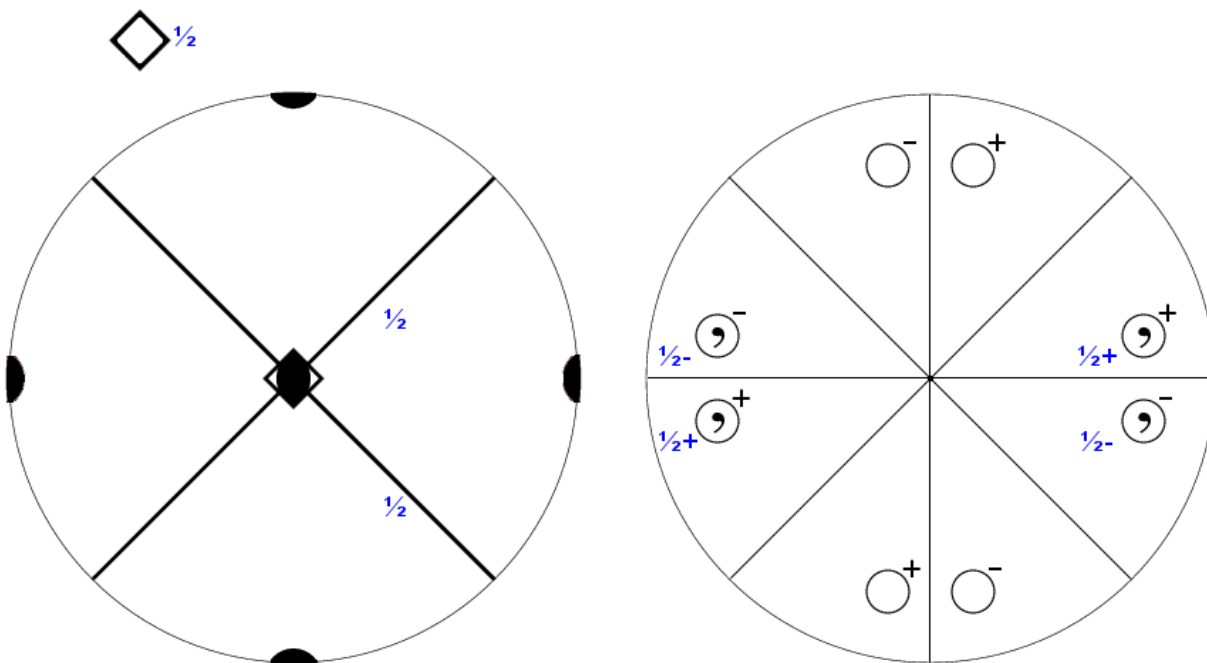

14.2.1.141

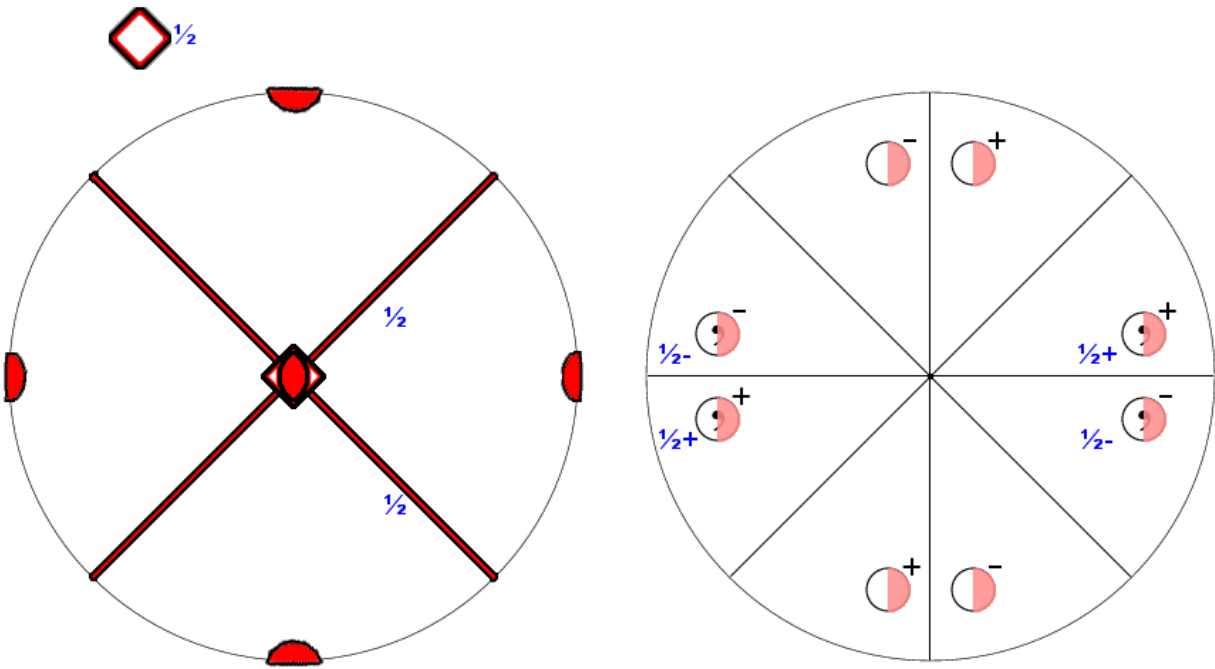

14.2.2.142

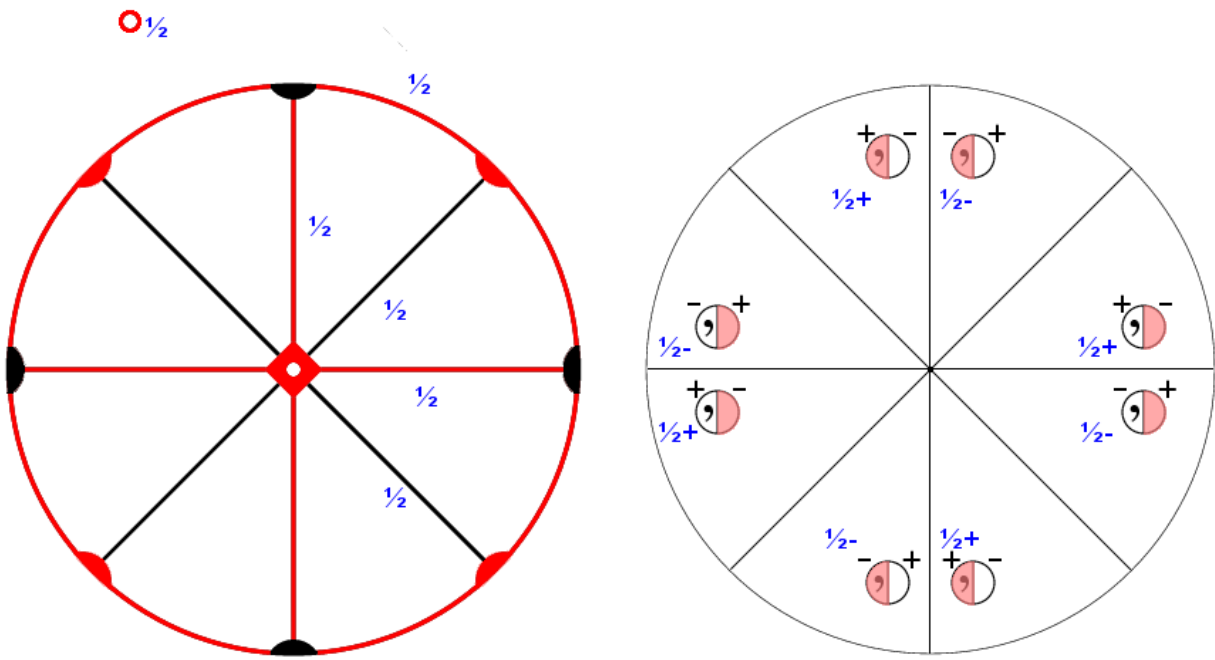

14.2.3.143

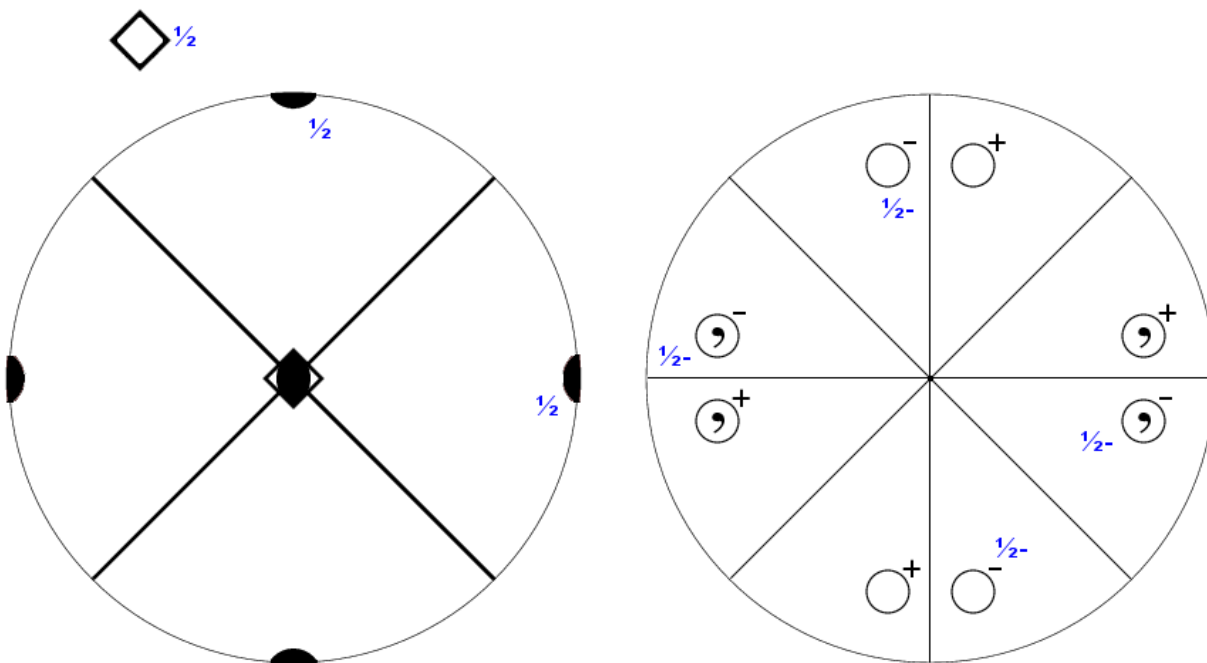

14.3.1.144

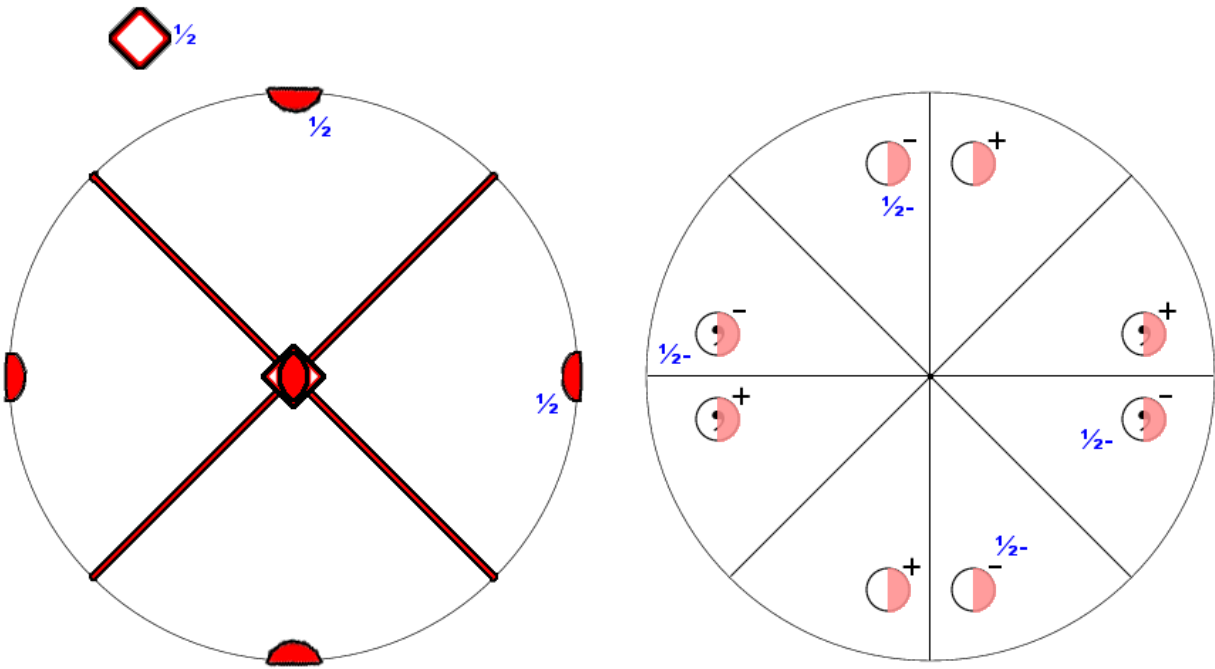

14.3.2.145

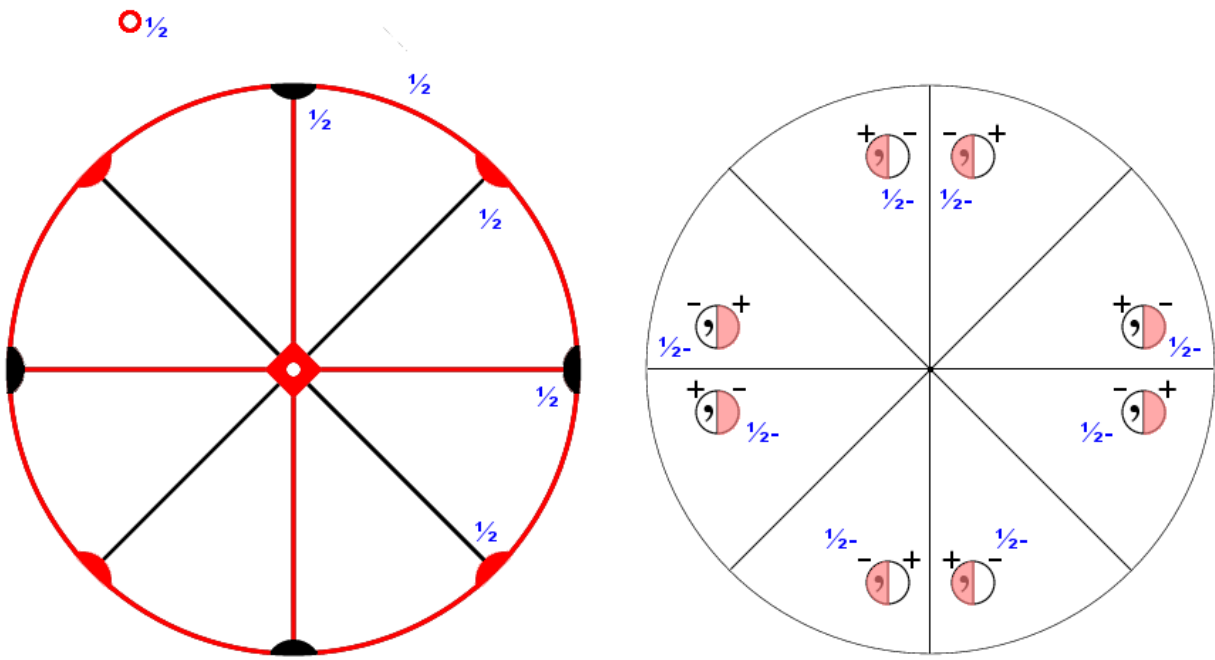

14.3.3.146

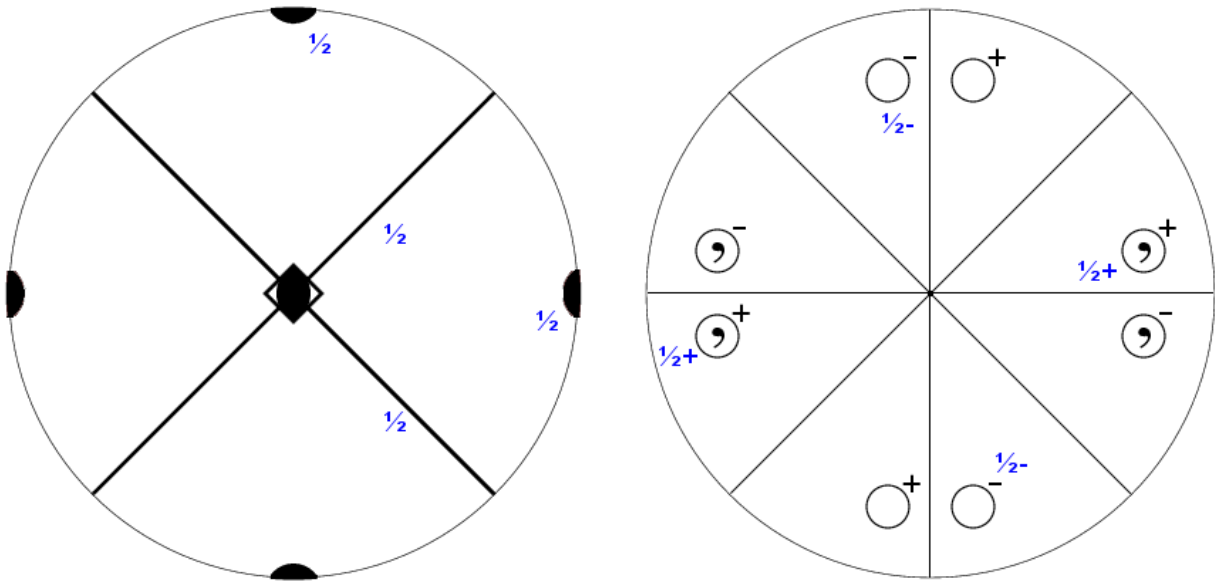

14.4.1.147

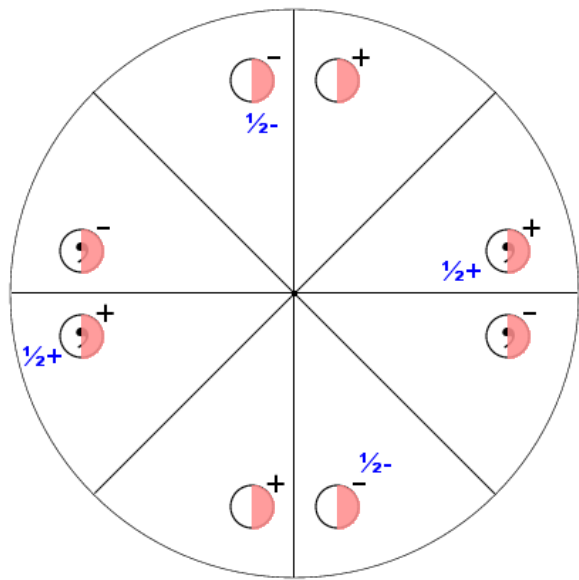
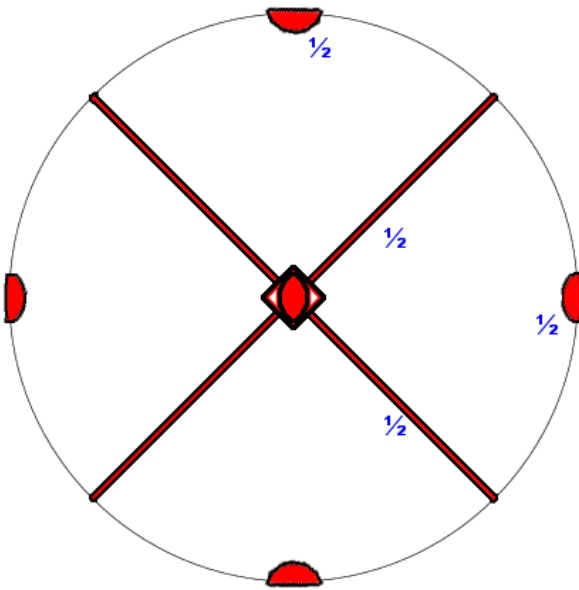

14.4.2.148

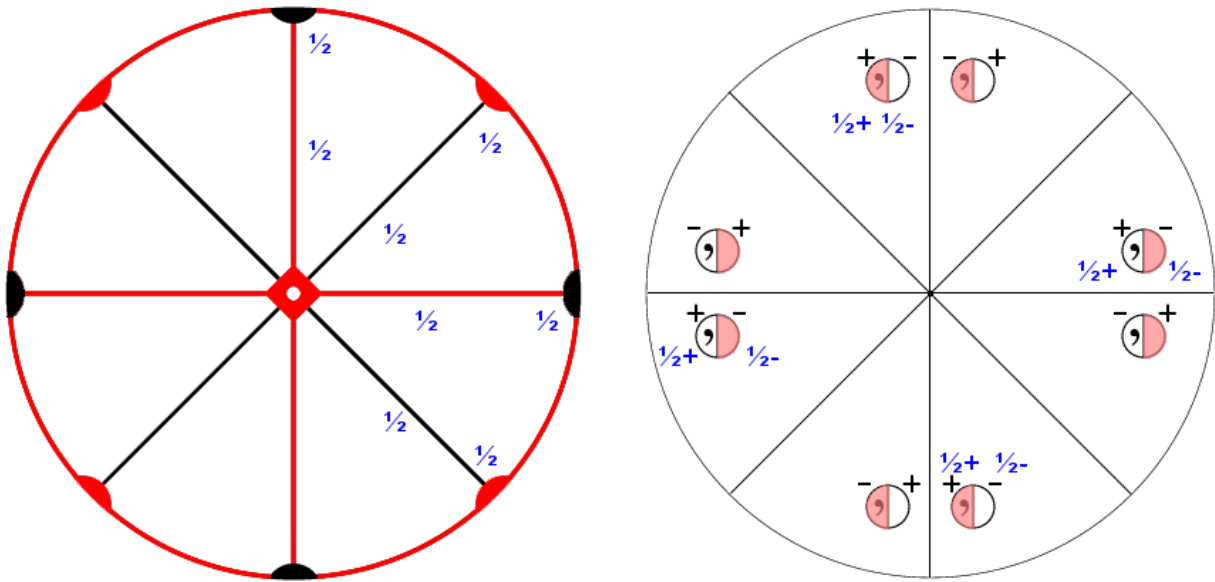

14.4.3.149

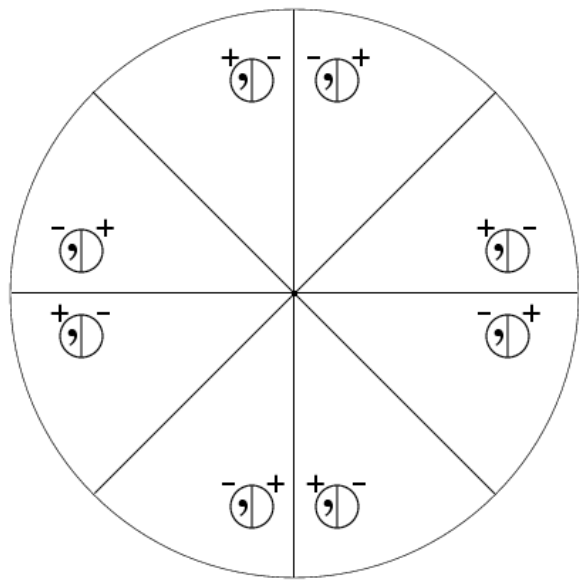
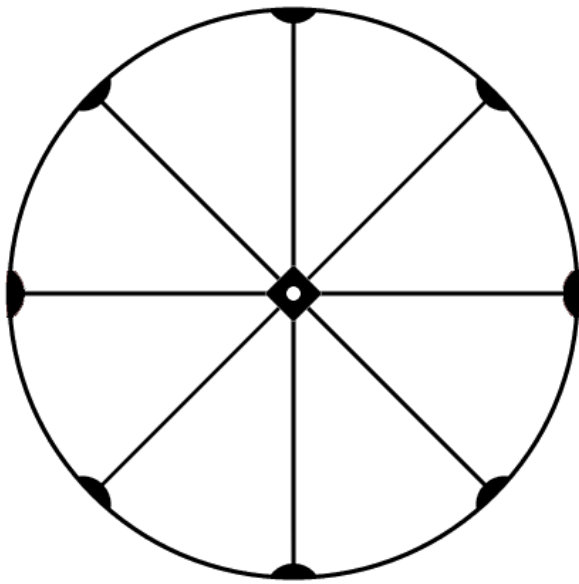

15.1.1.150

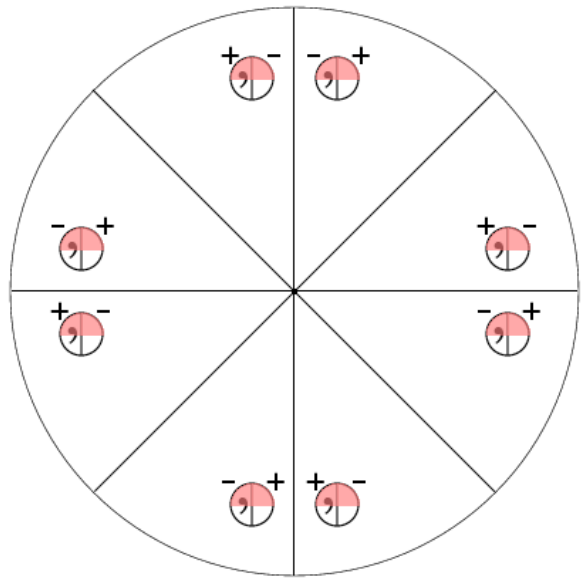
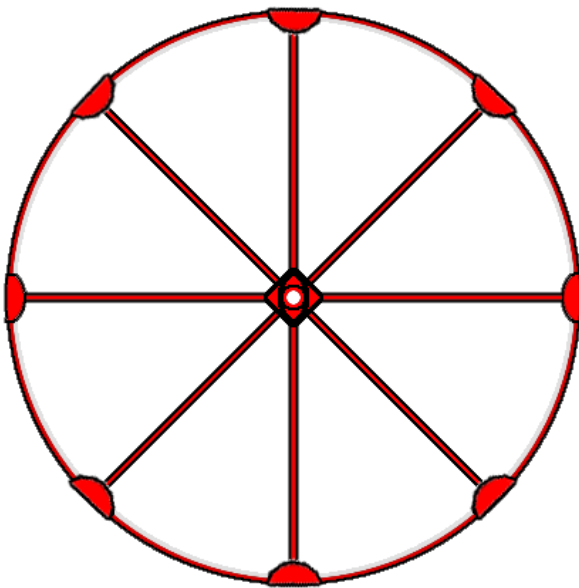

15.1.2.151

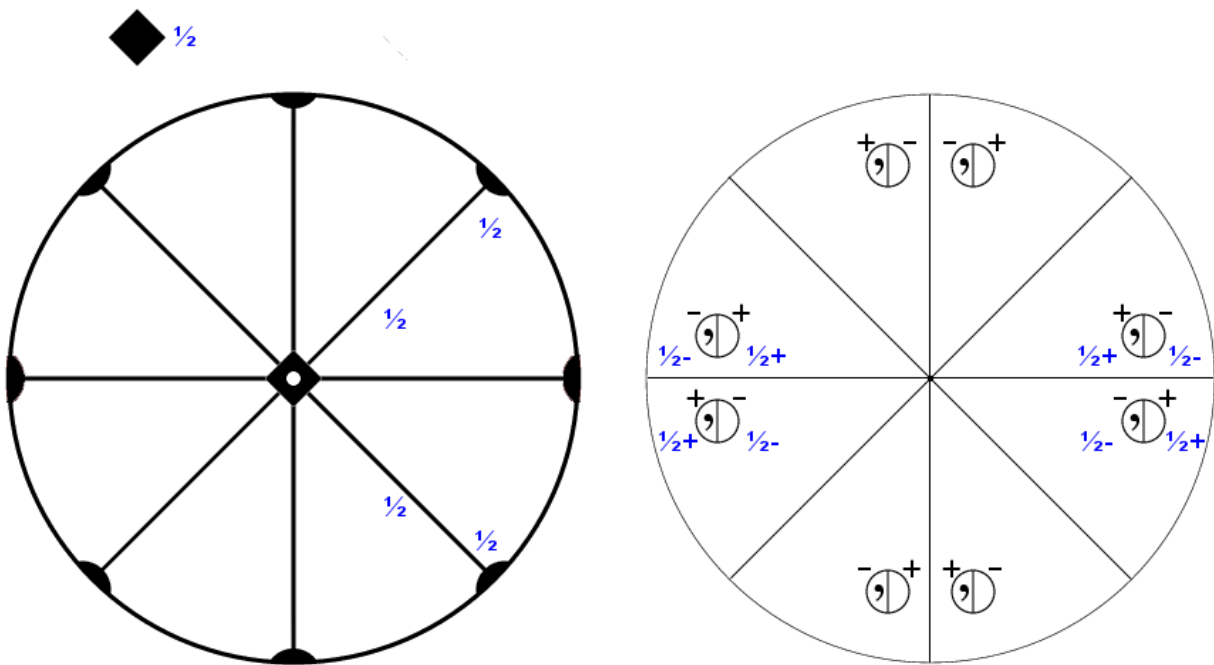

15.2.1.152

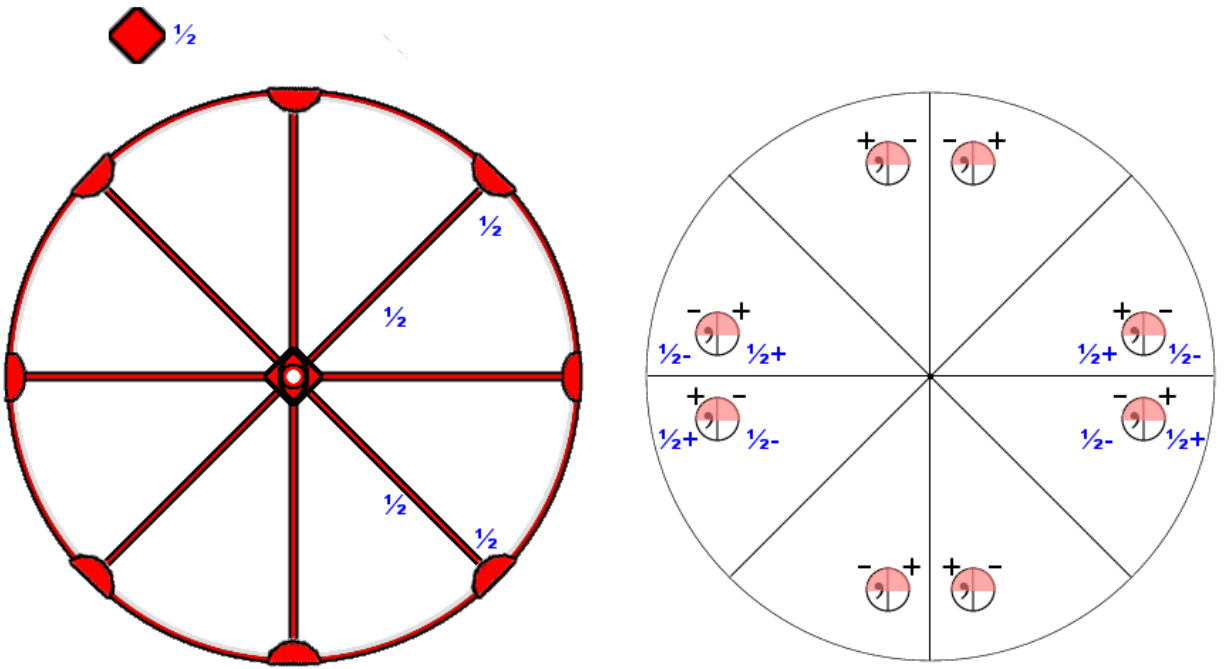

15.2.2.153

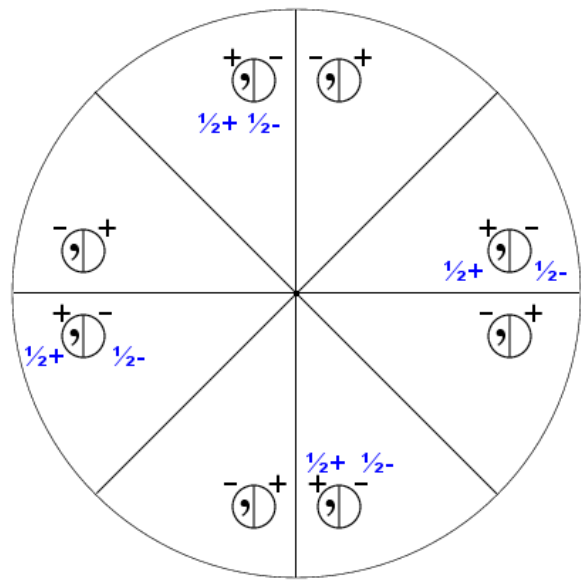
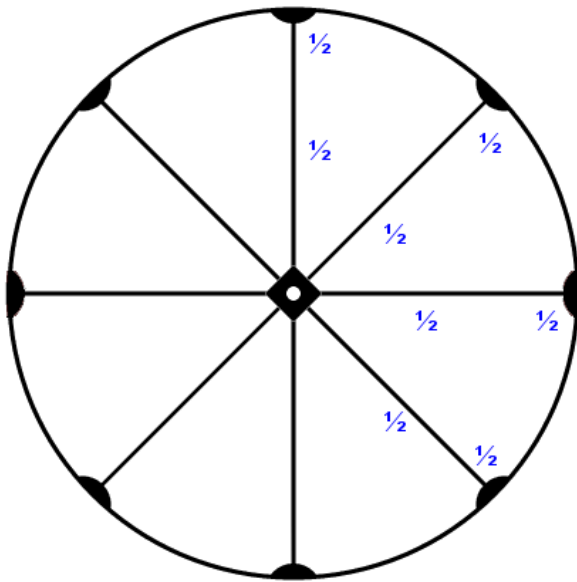

15.3.1.154

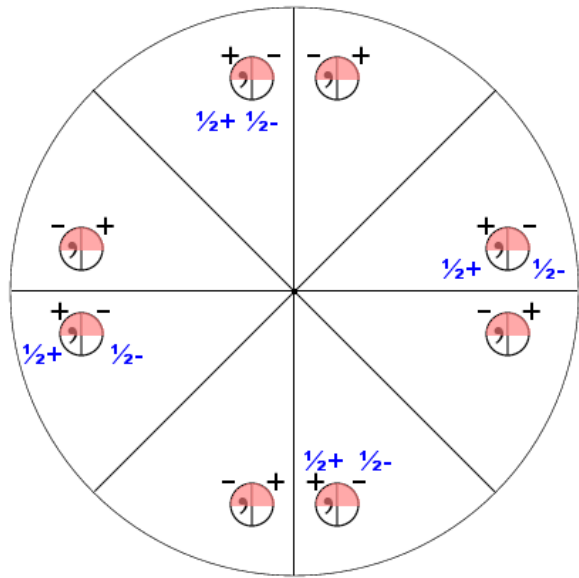
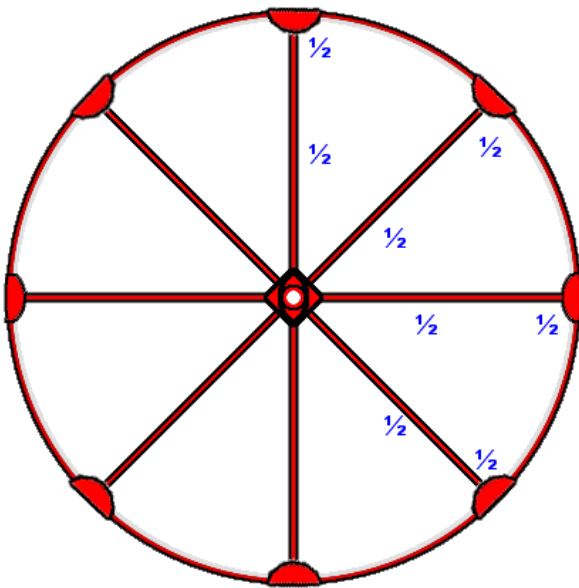

15.3.2.155

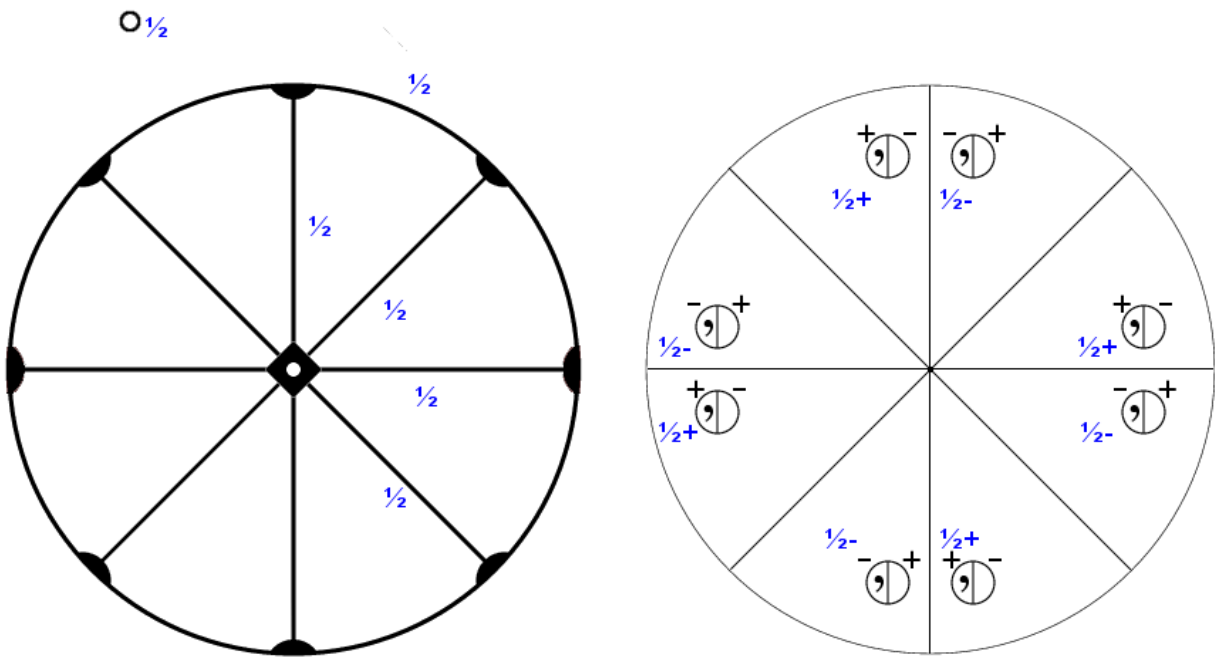

15.4.1.156

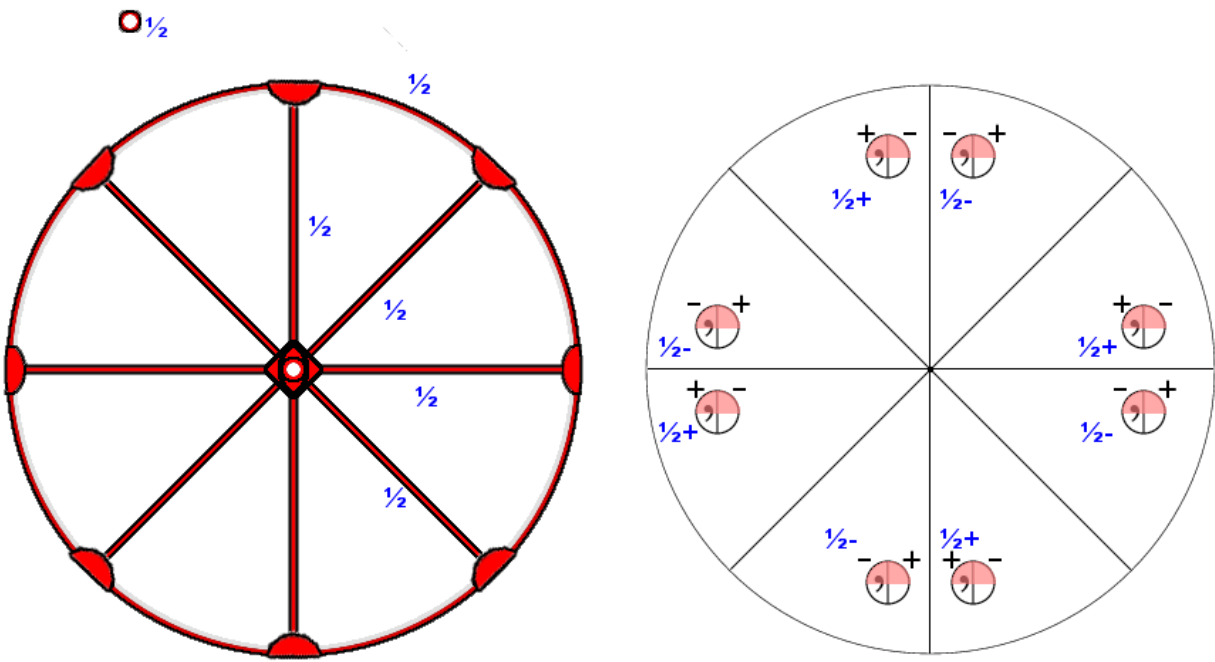

15.4.2.157

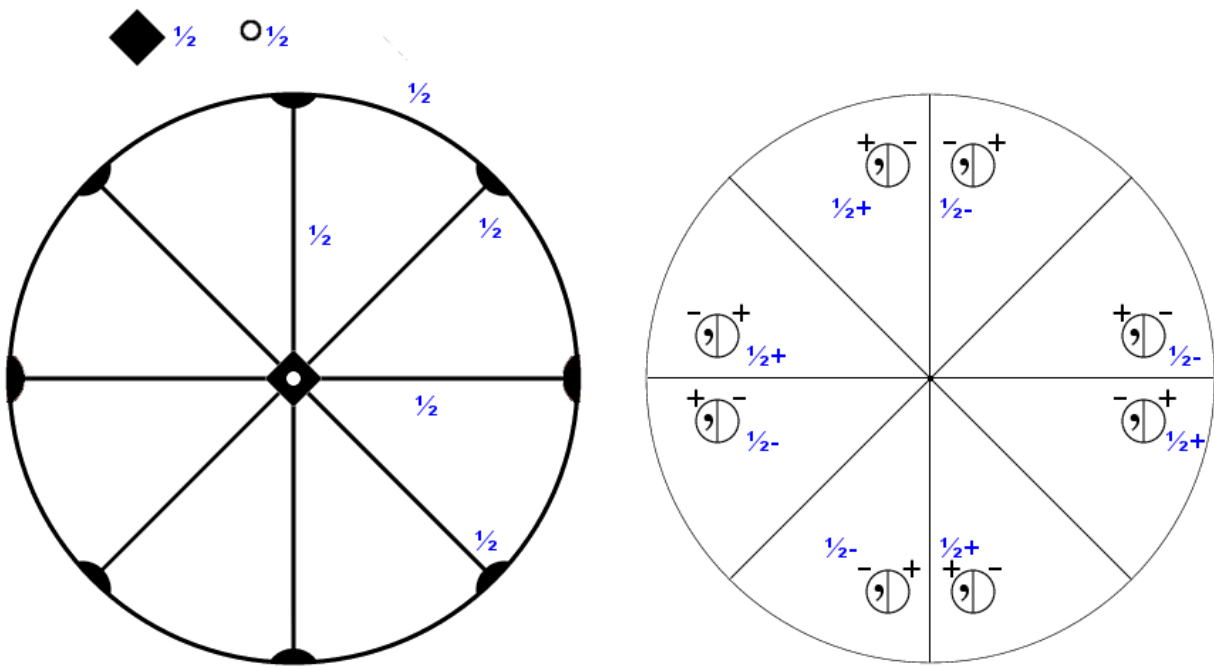

15.5.1.158

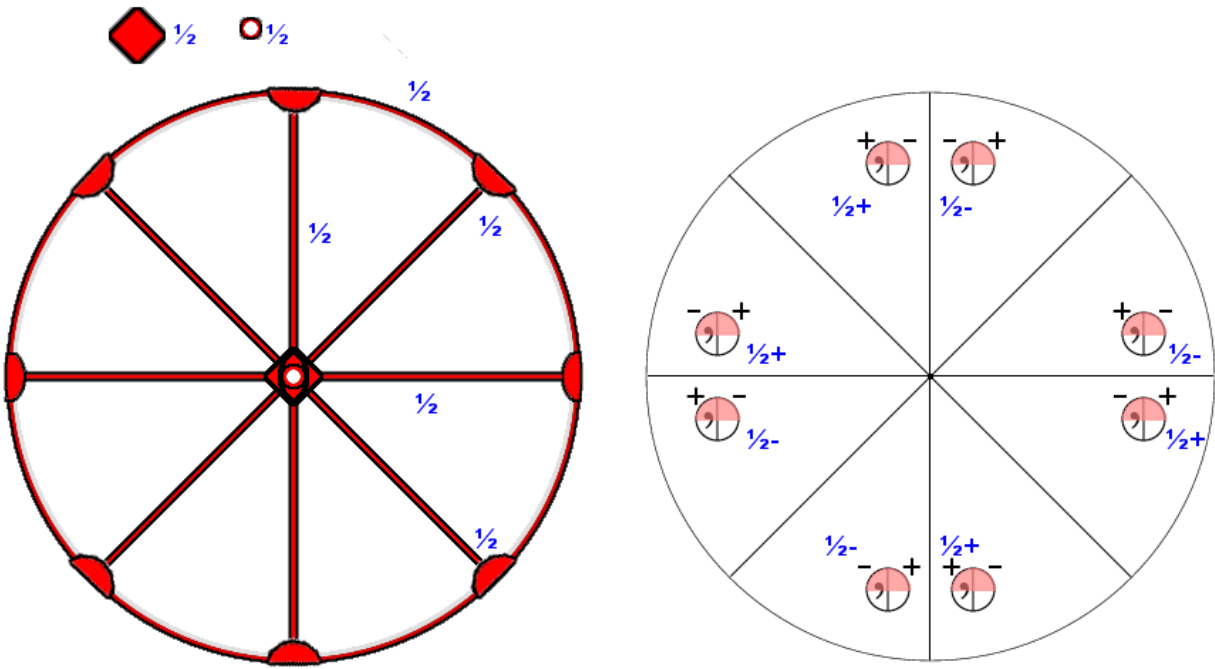

15.5.2.159

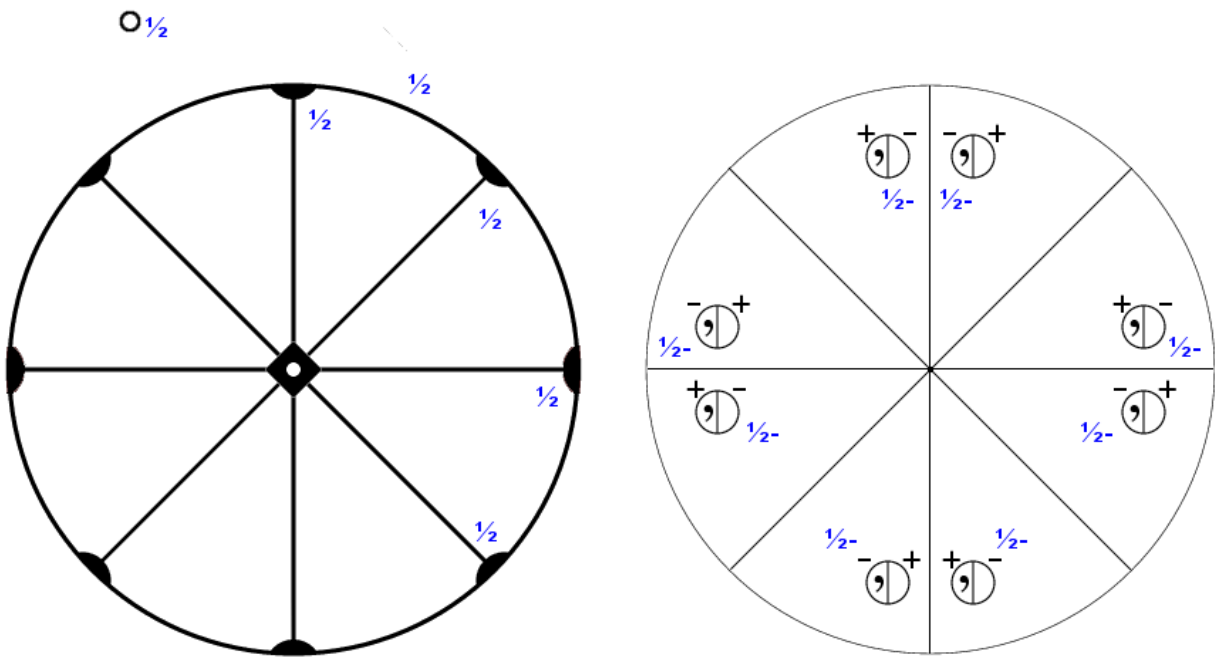

15.6.1.160

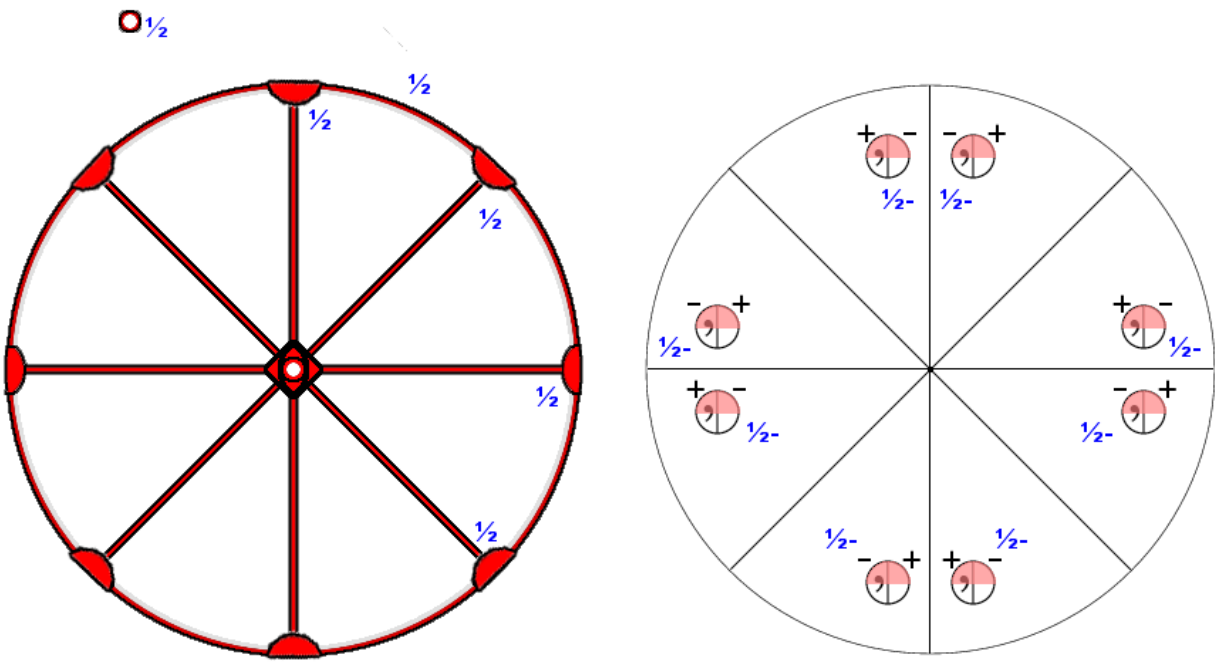

15.6.2.161

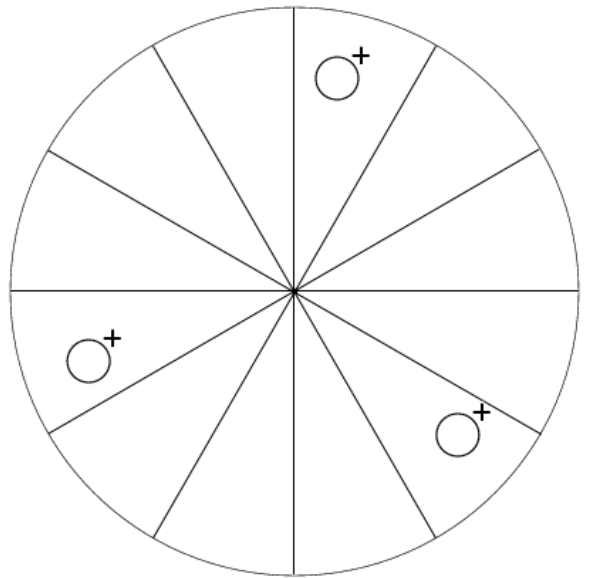
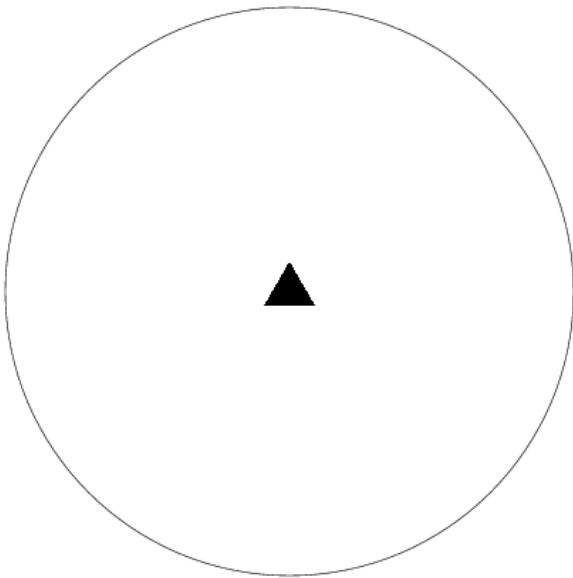

16.1.1.162

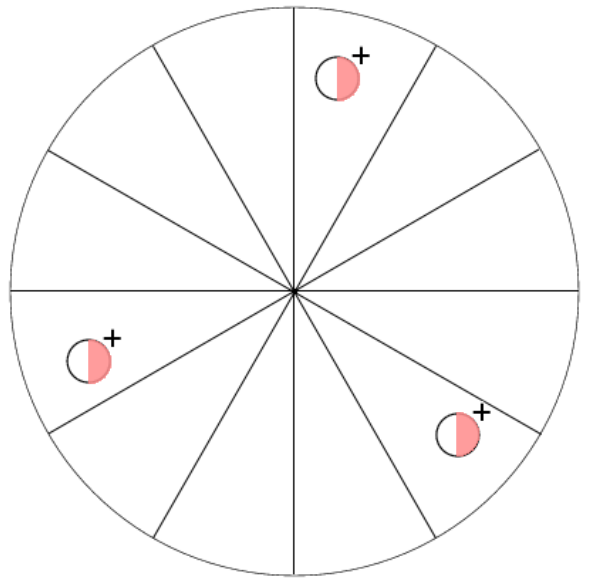
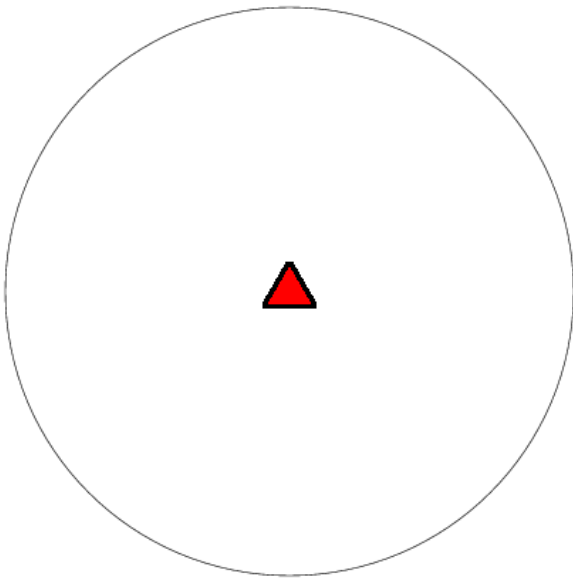

16.1.2.163

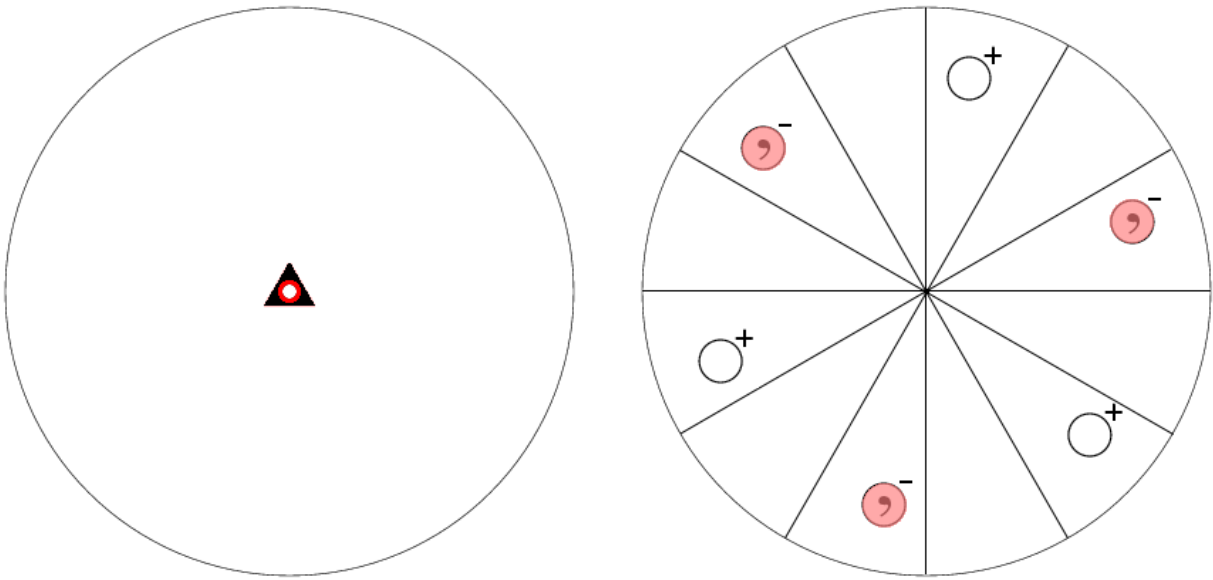

16.1.3.164

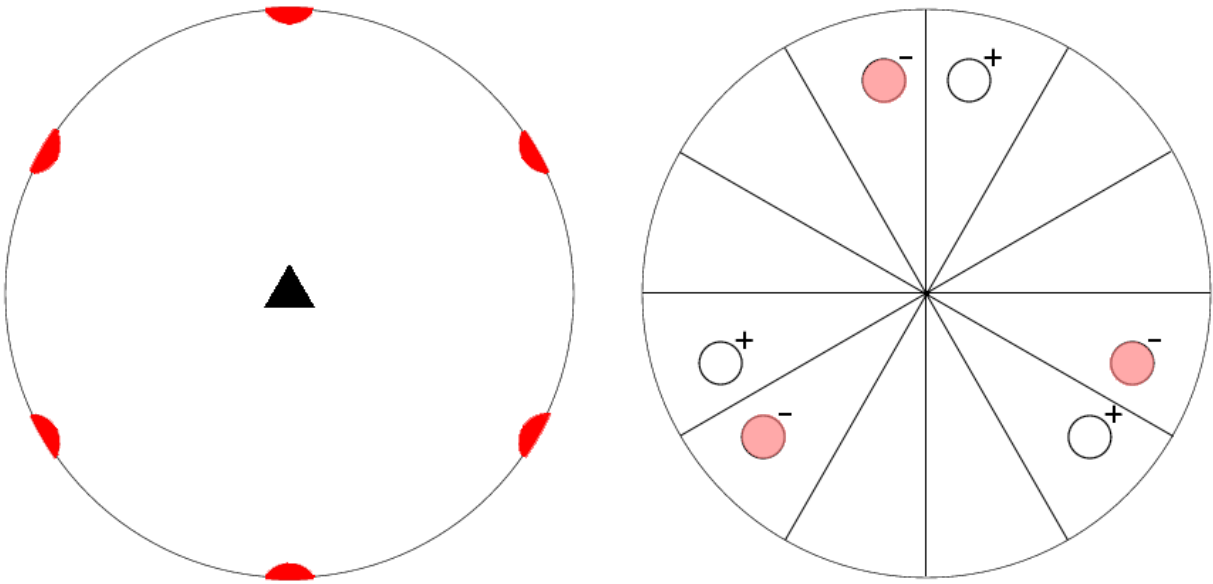

16.1.4.165

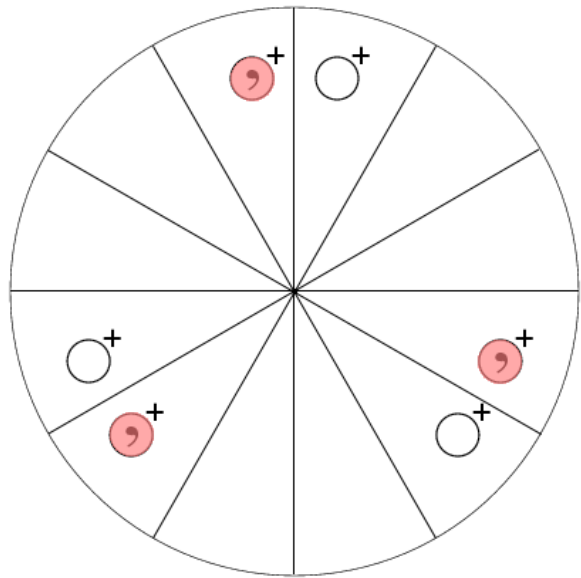
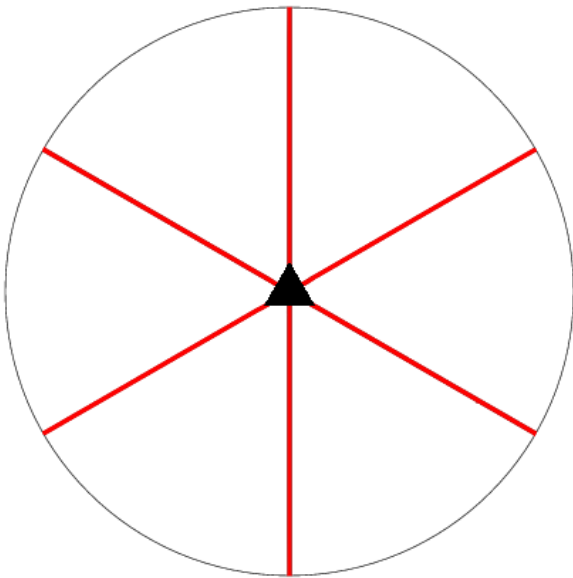

16.1.5.166

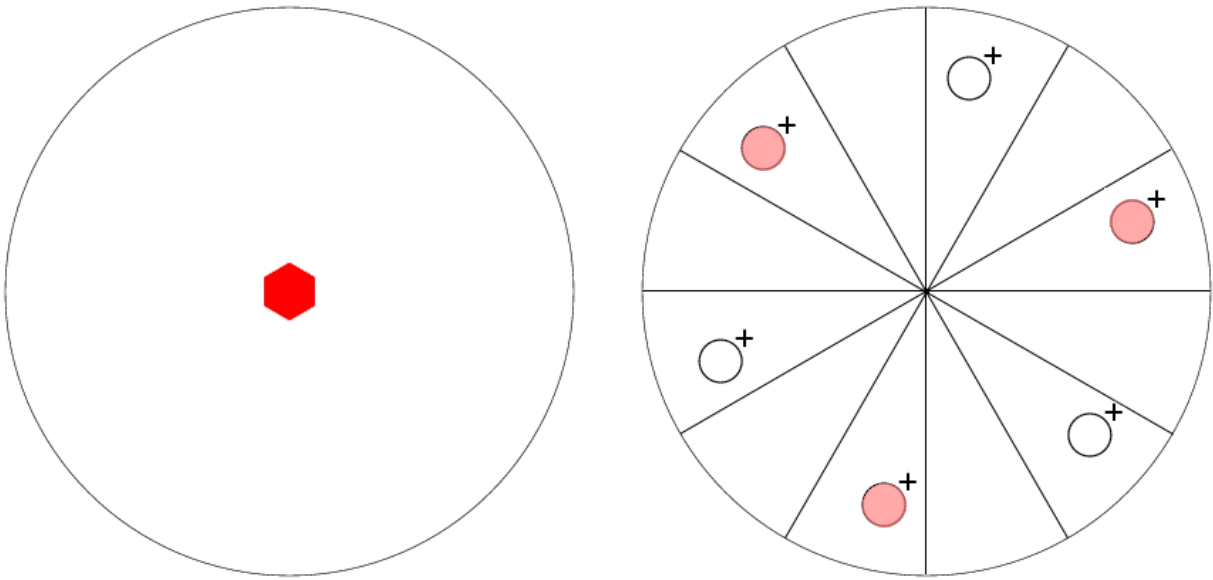

16.1.6.167

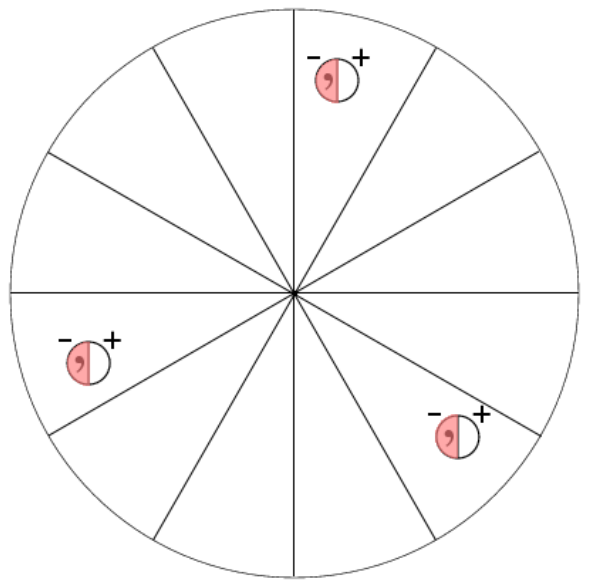
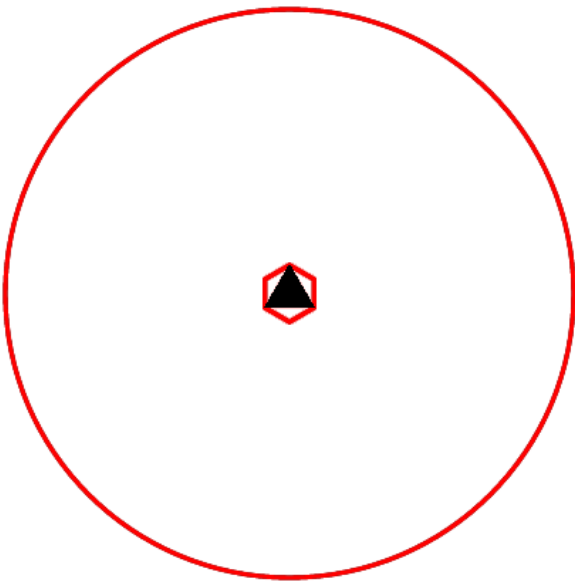

16.1.7.168

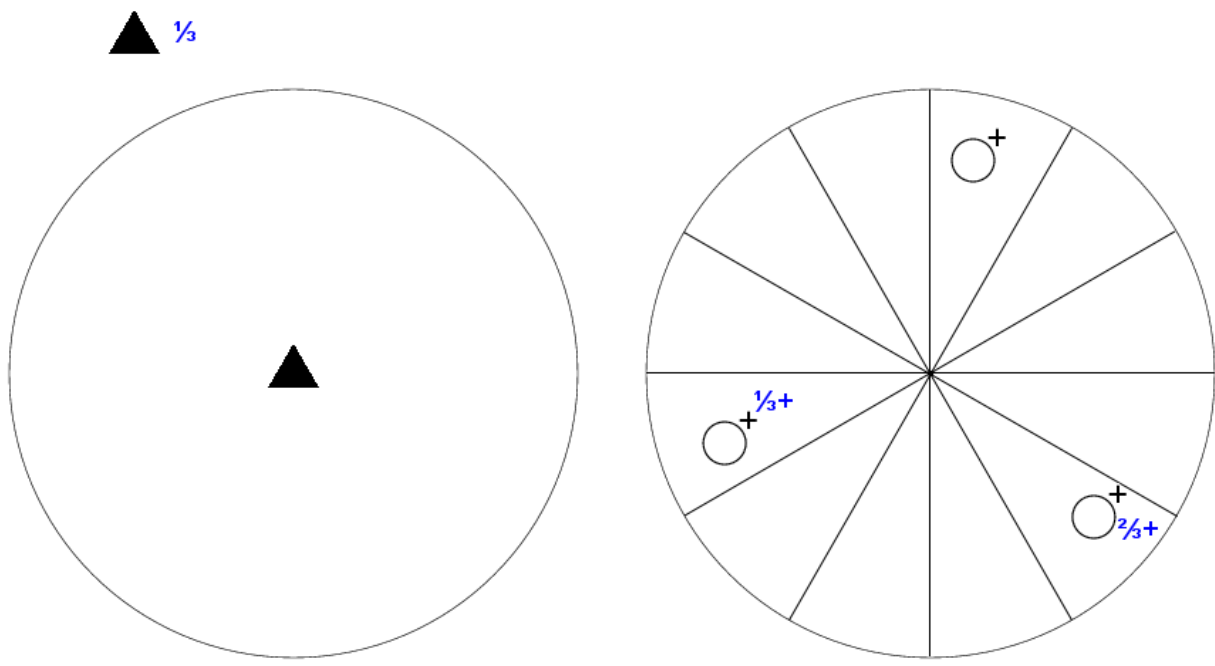

16.2.1.169

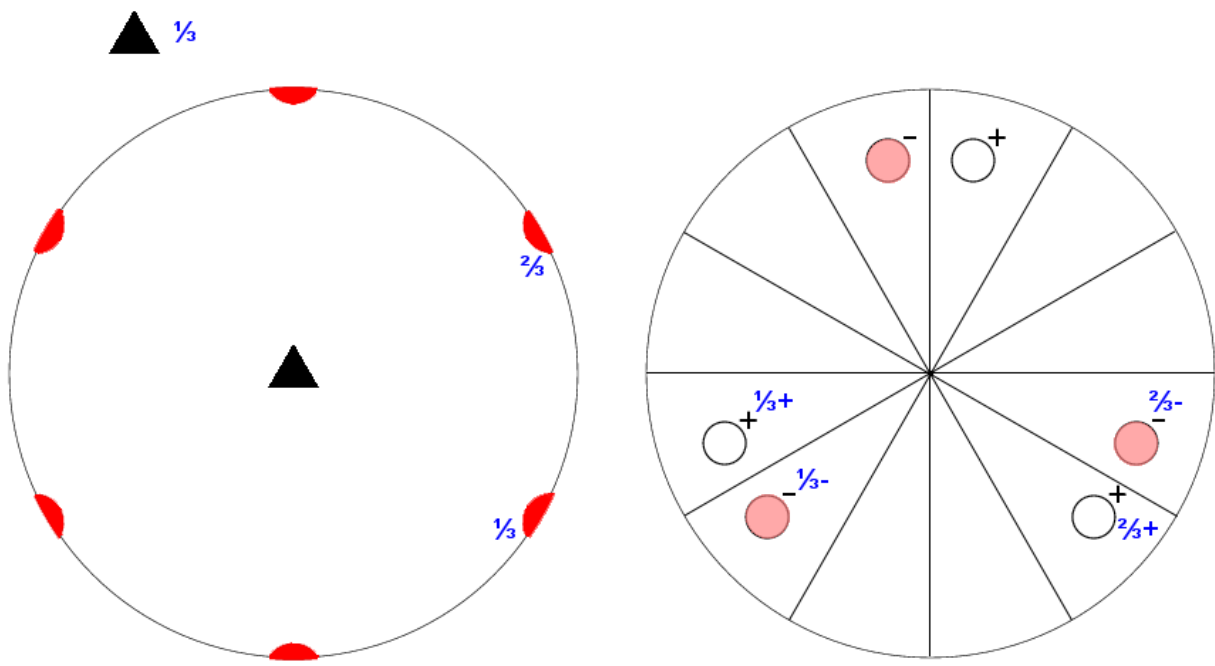

16.2.2.170

▲ $\frac{1}{3}$

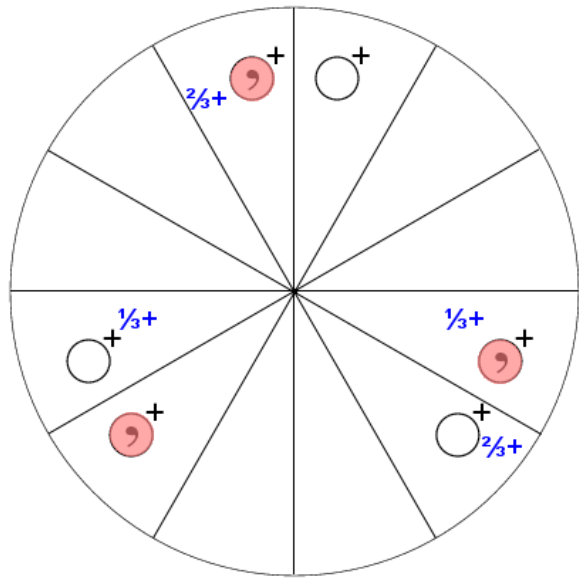
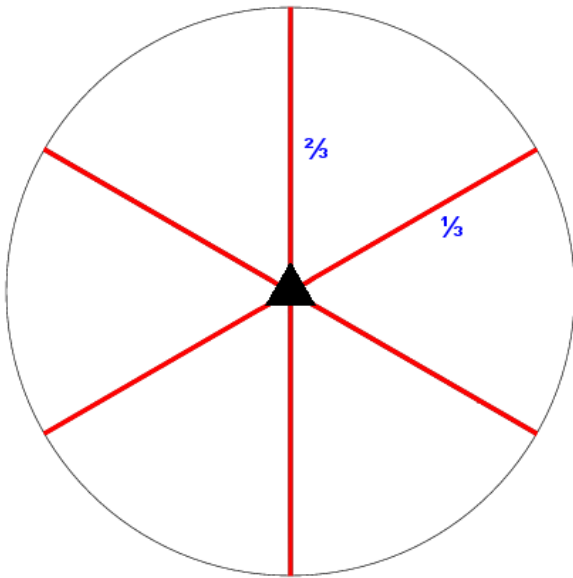

16.2.3.171

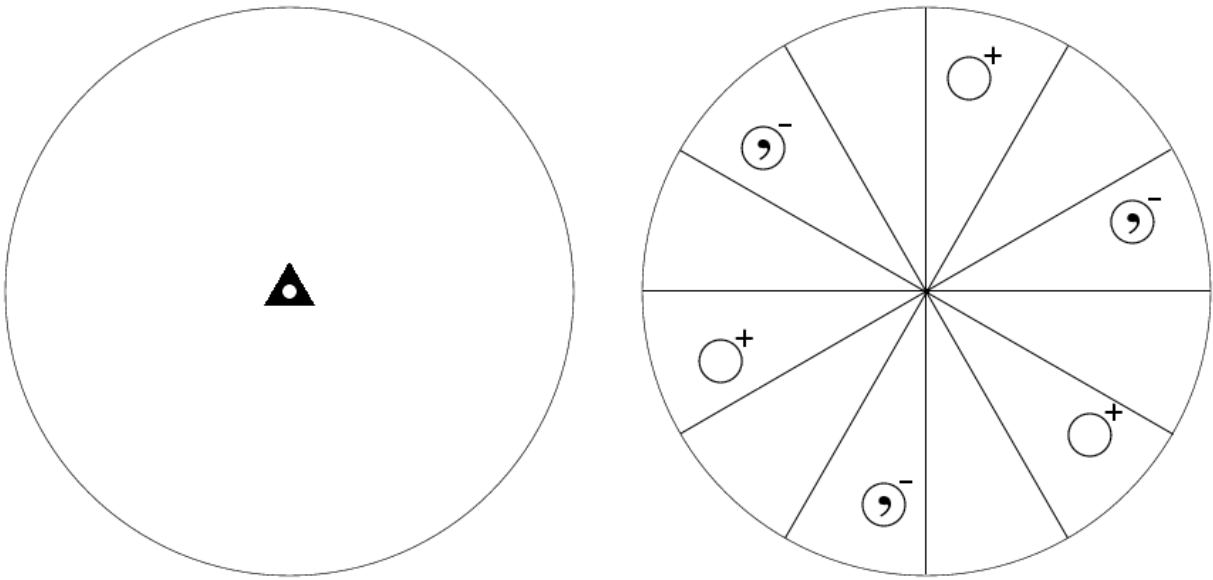

17.1.1.172

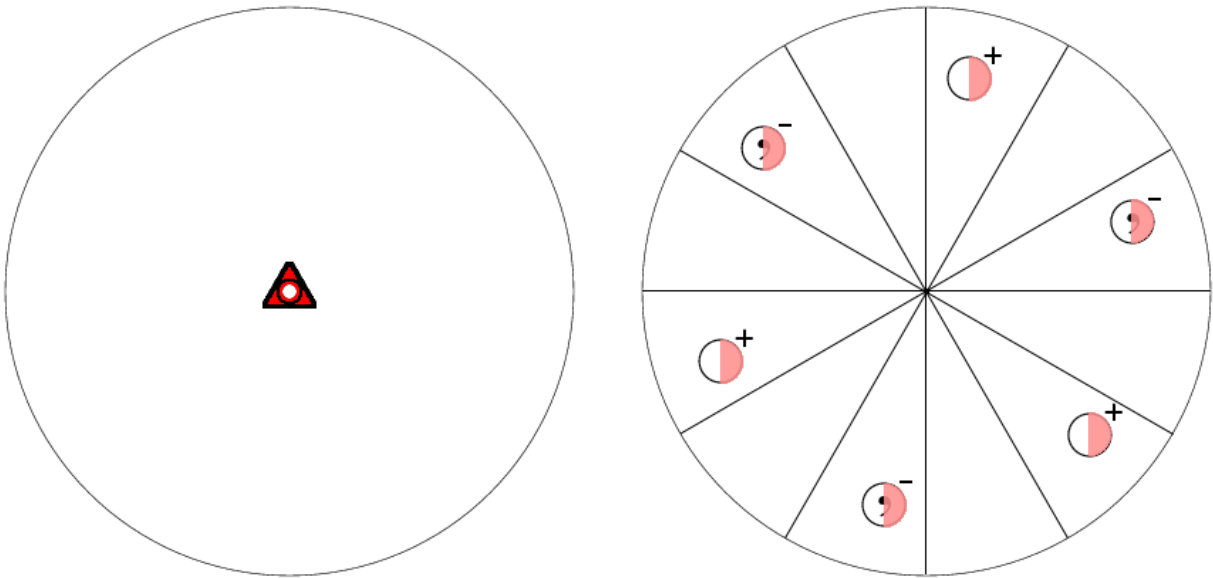

17.1.2.173

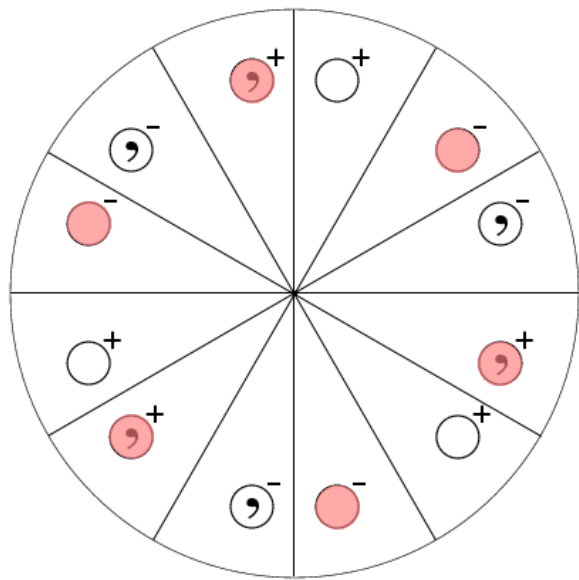
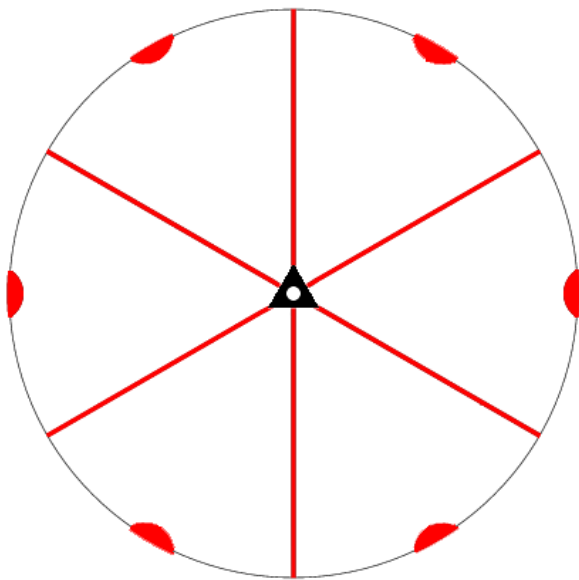

17.1.3.174

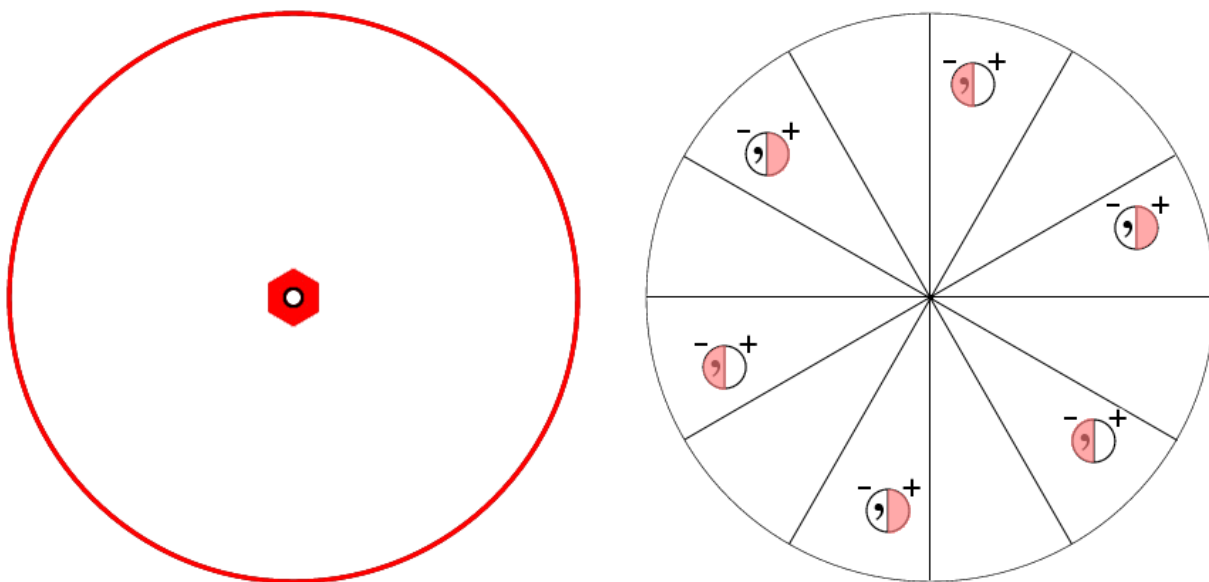

17.1.4.175

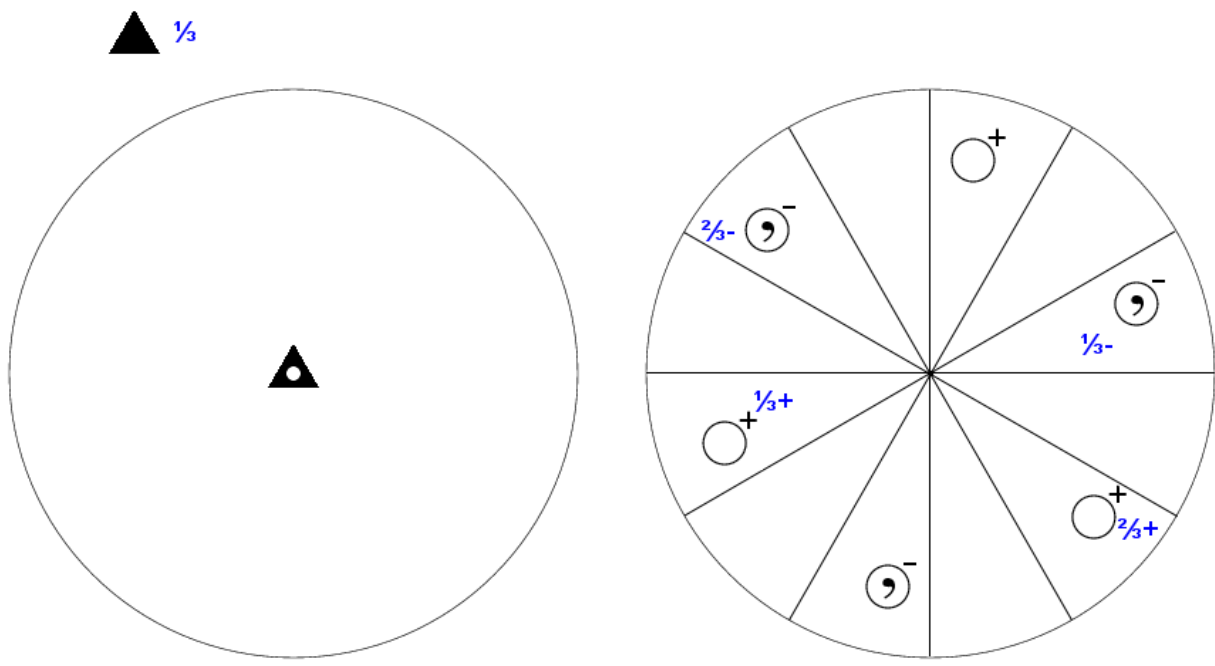

17.2.1.176

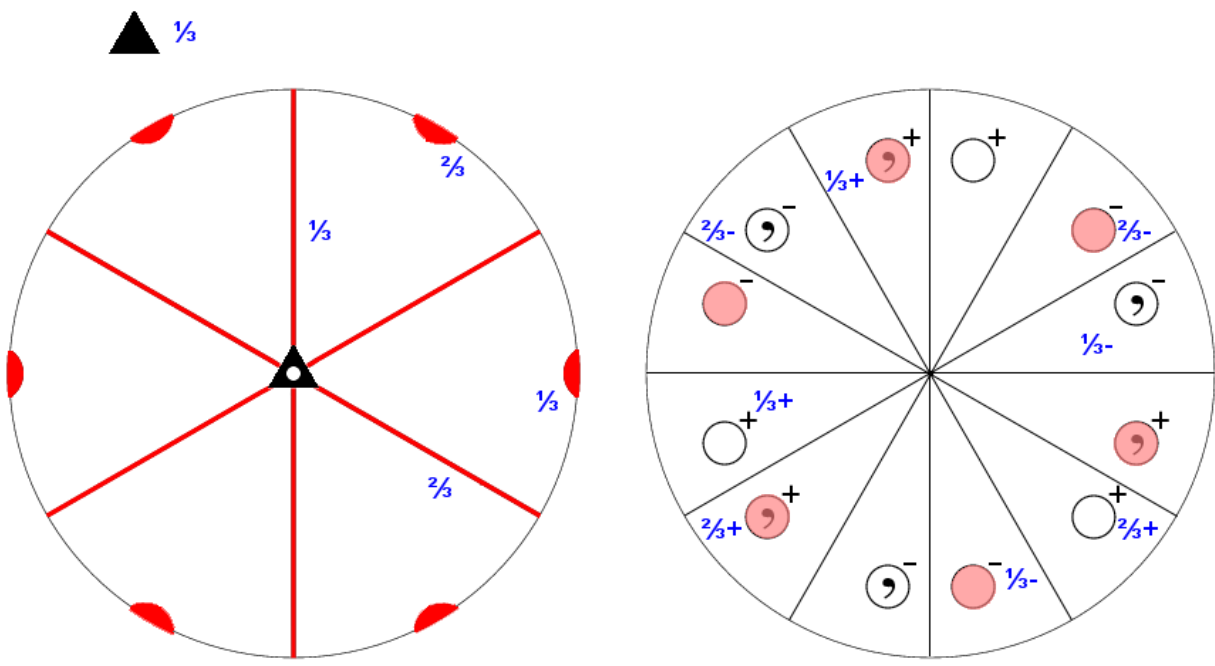

17.2.2.177

$\circ\frac{1}{2}$

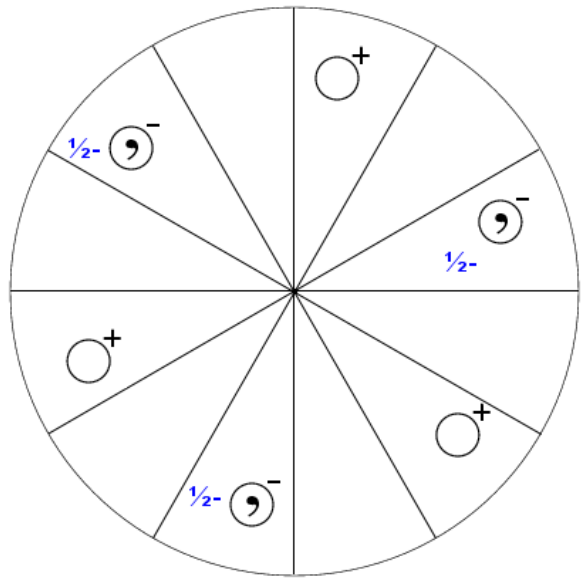
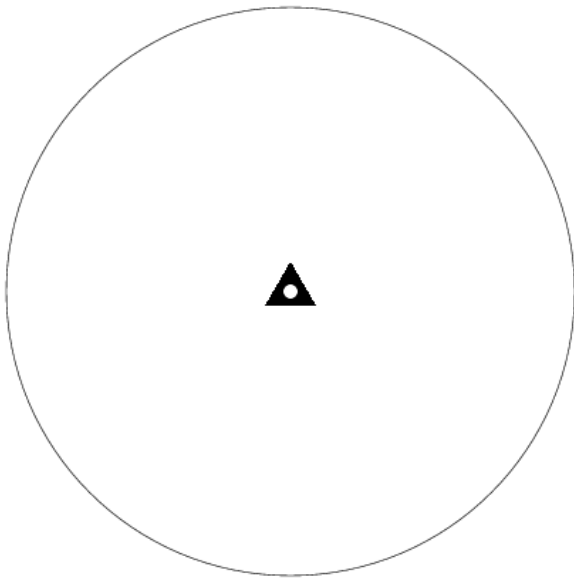

17.3.1.178

$\odot \frac{1}{2}$

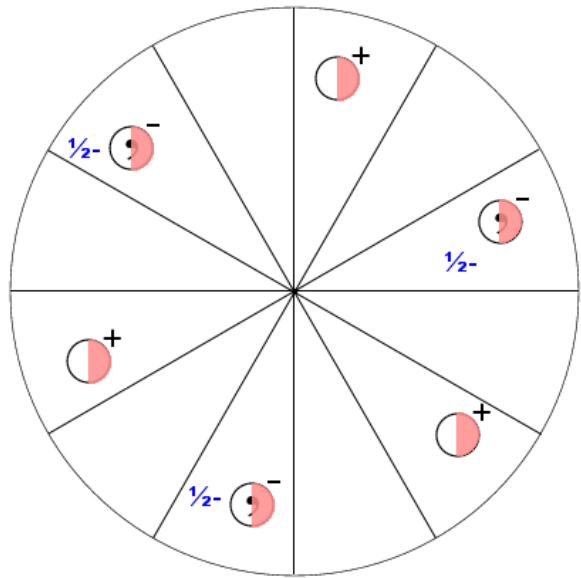
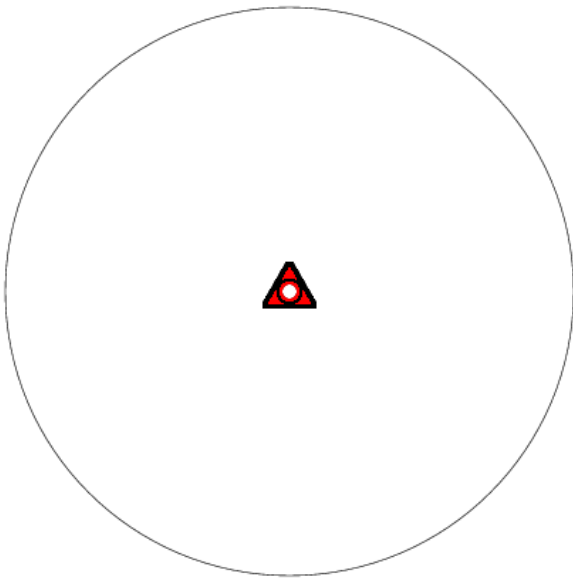

17.3.2.179

$\circ \frac{1}{2}$

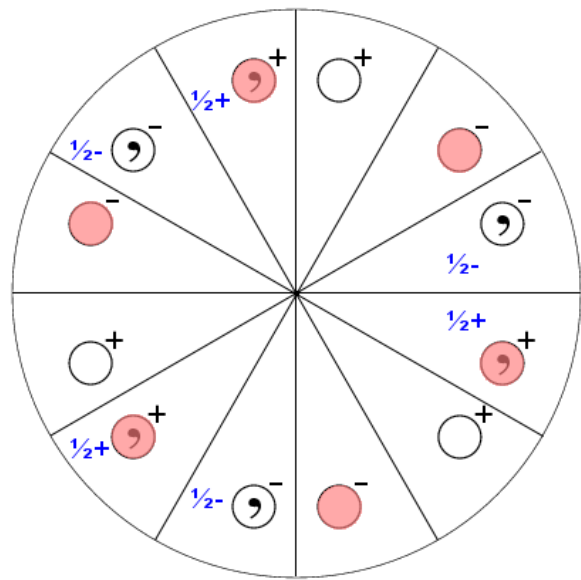
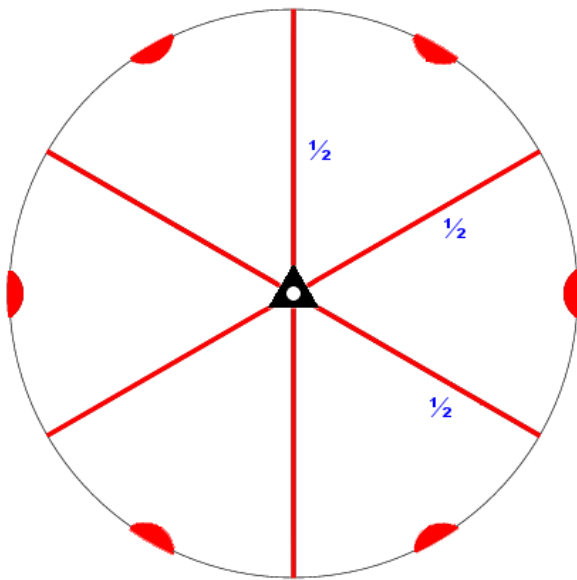

17.3.3.180

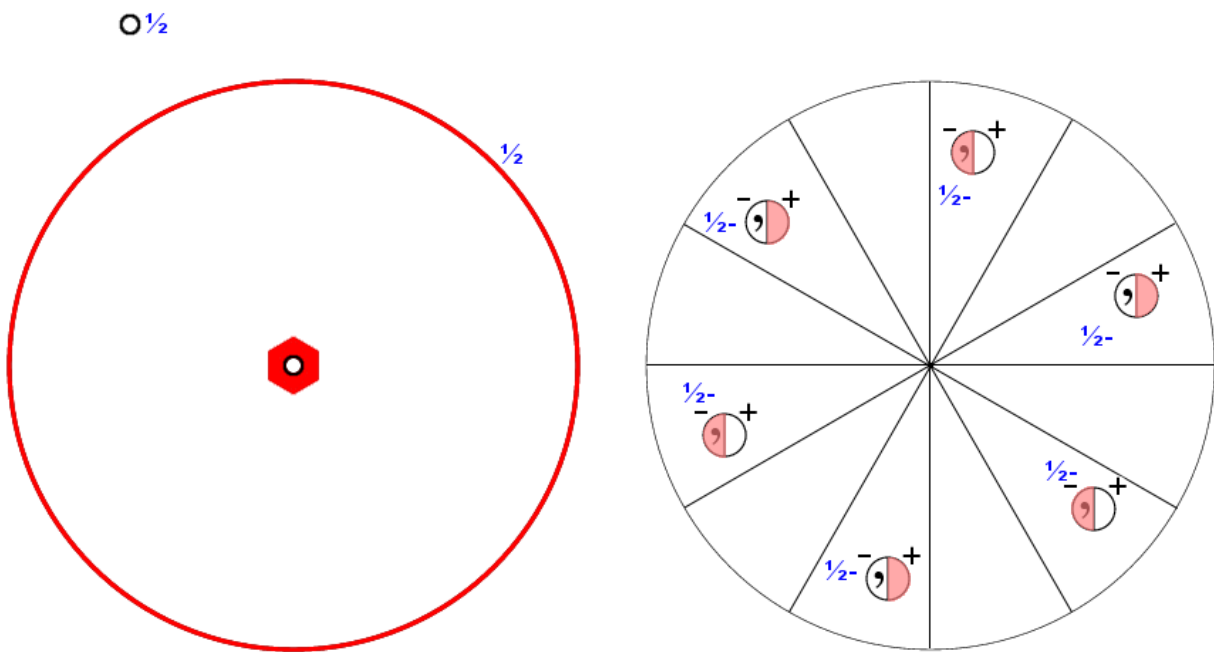

17.3.4.181

▲ $\frac{1}{3}$ ○ $\frac{1}{2}$

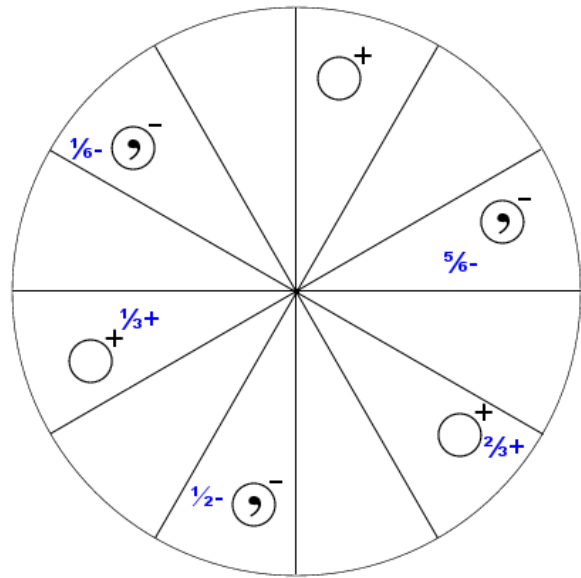
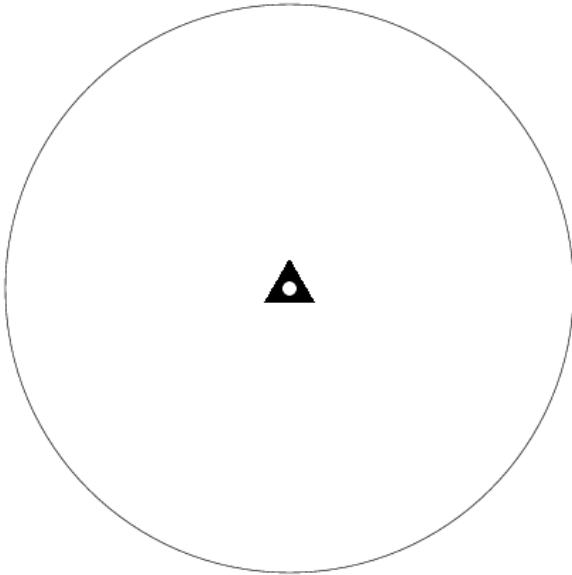

17.4.1.182

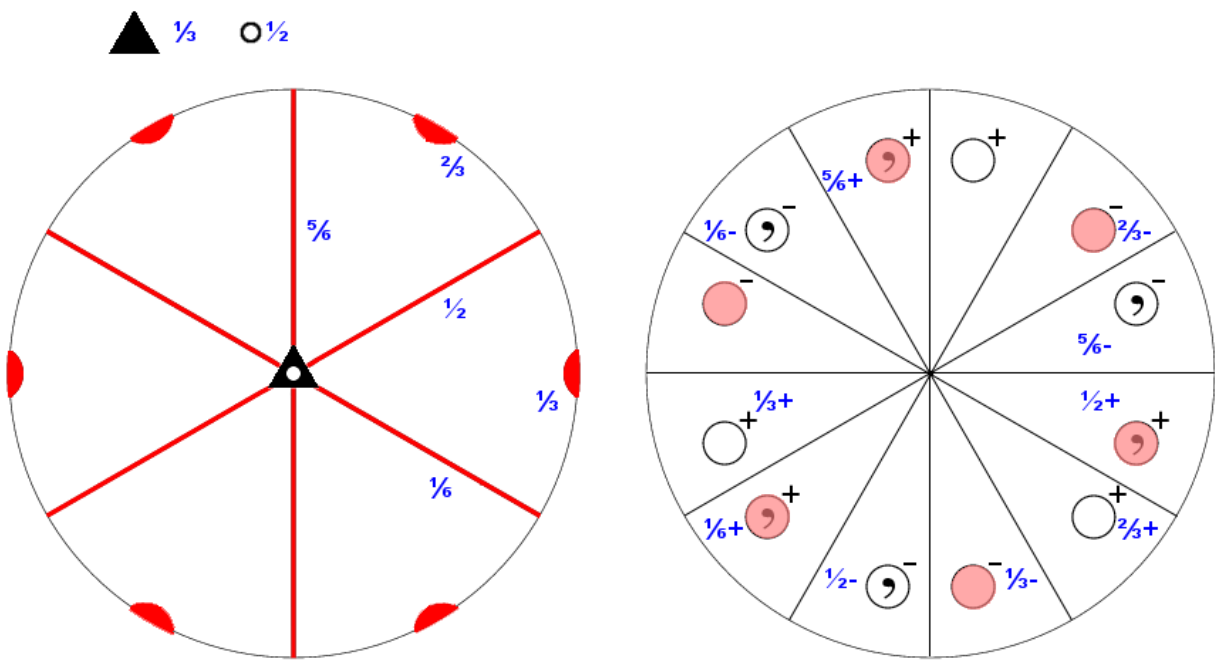

17.4.2.183

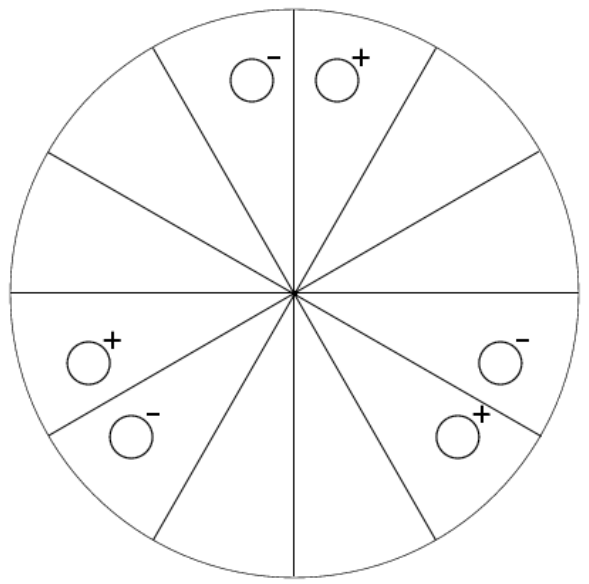
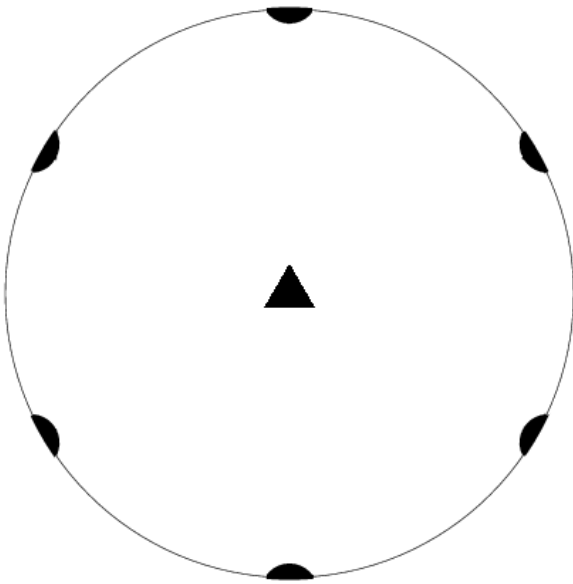

18.1.1.184

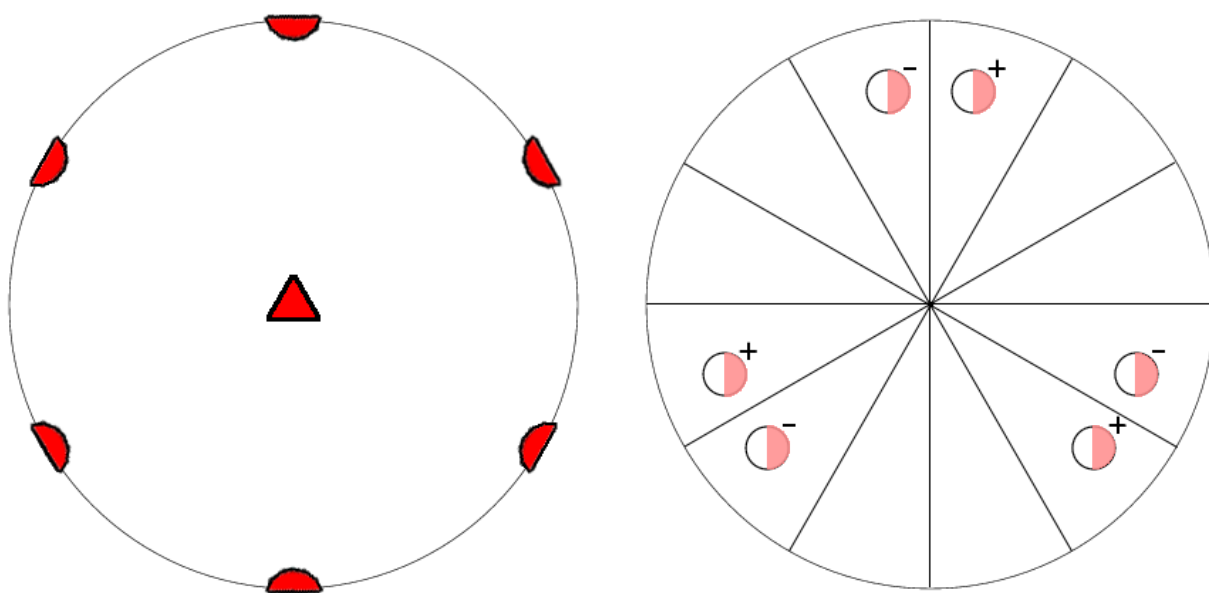

18.1.2.185

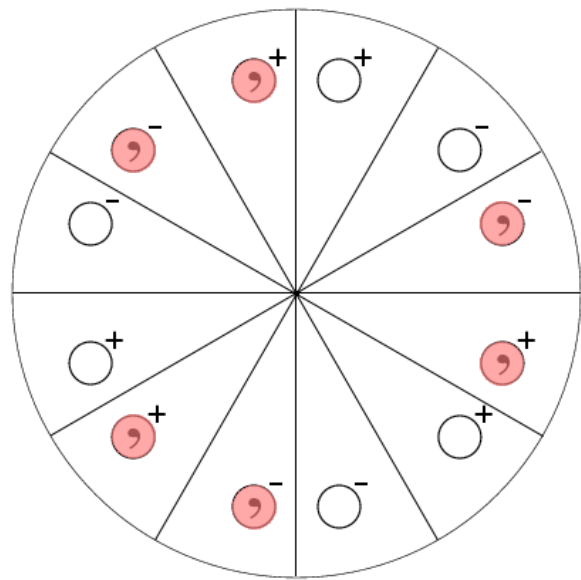
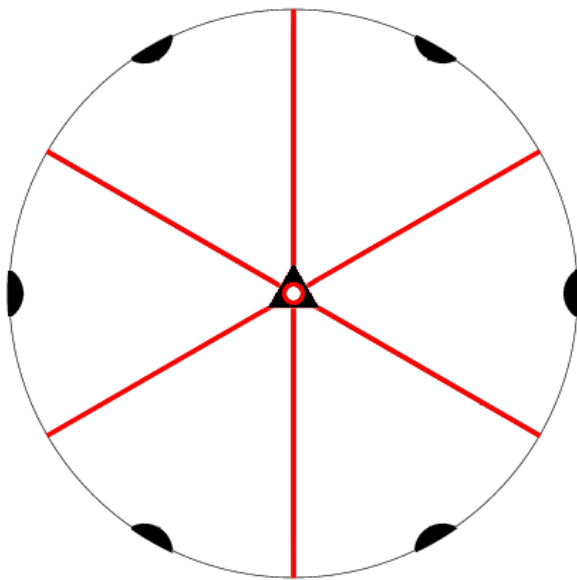

18.1.3.186

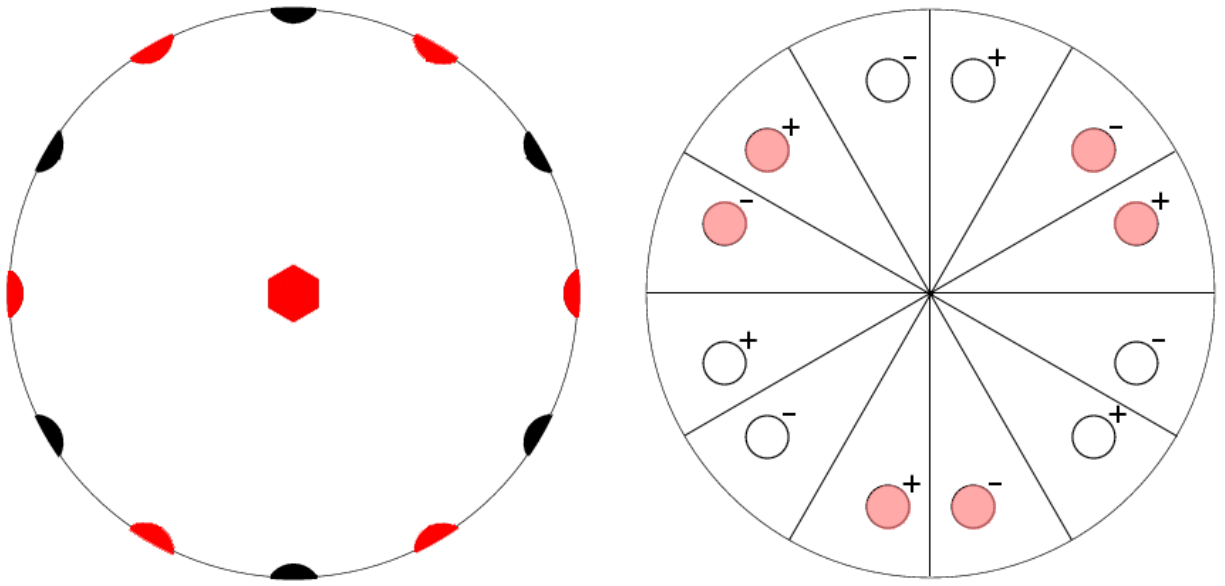

18.1.4.187

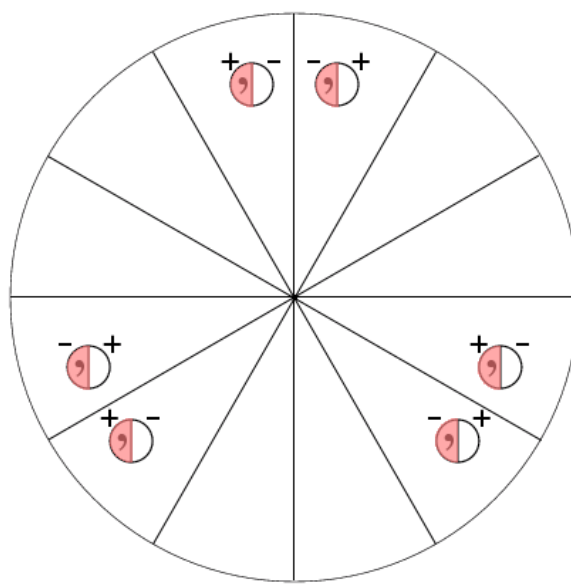
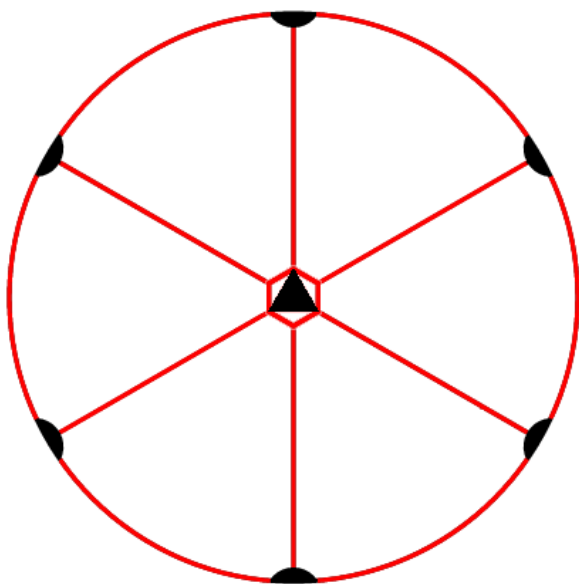

18.1.5.188

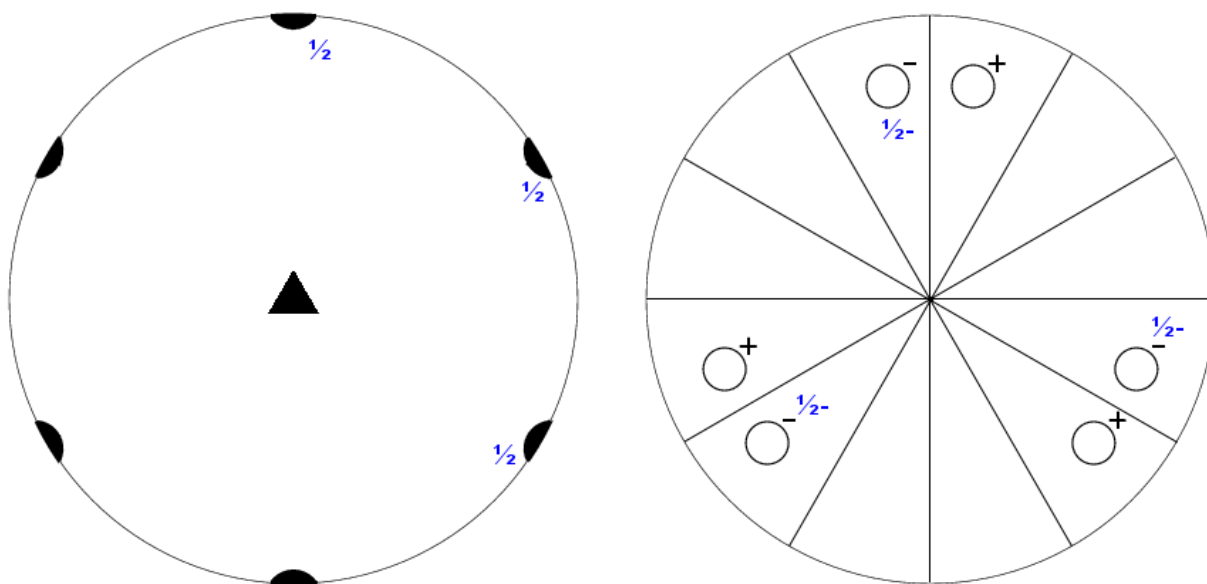

18.2.1.189

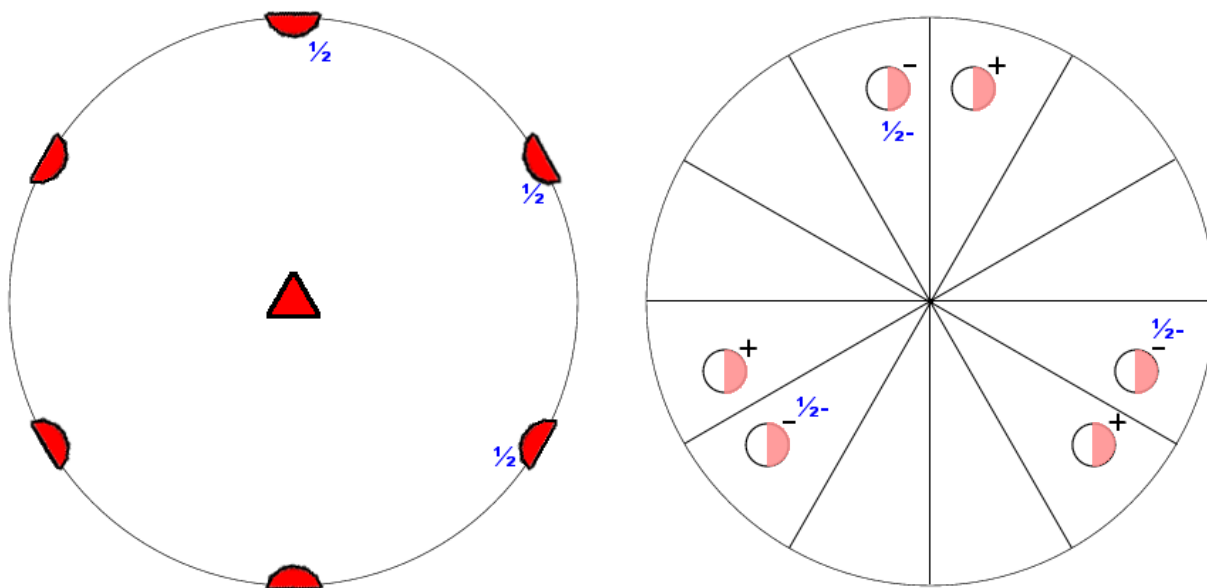

18.2.2.190

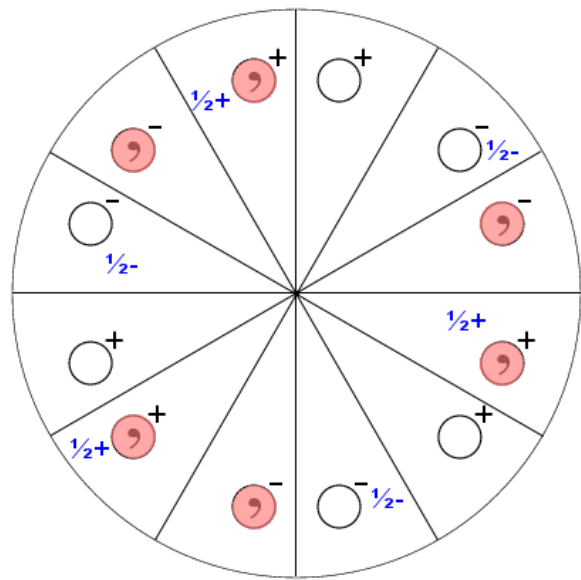
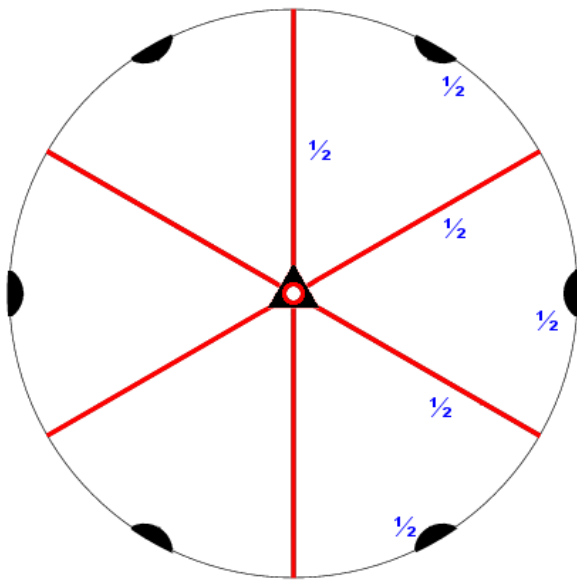

18.2.3.191

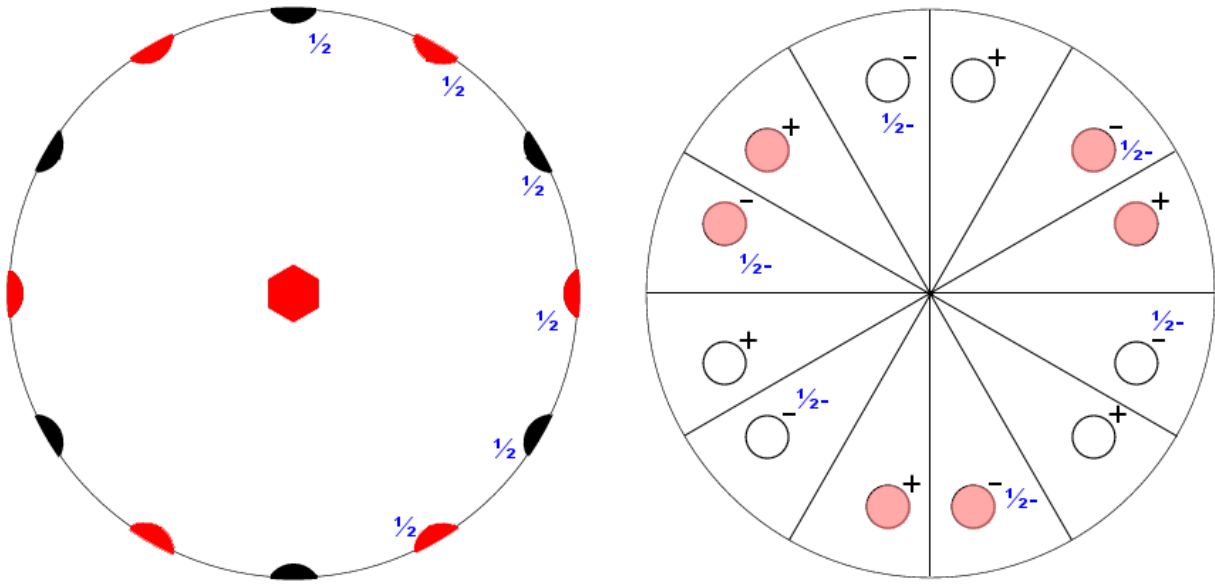

18.2.4.192

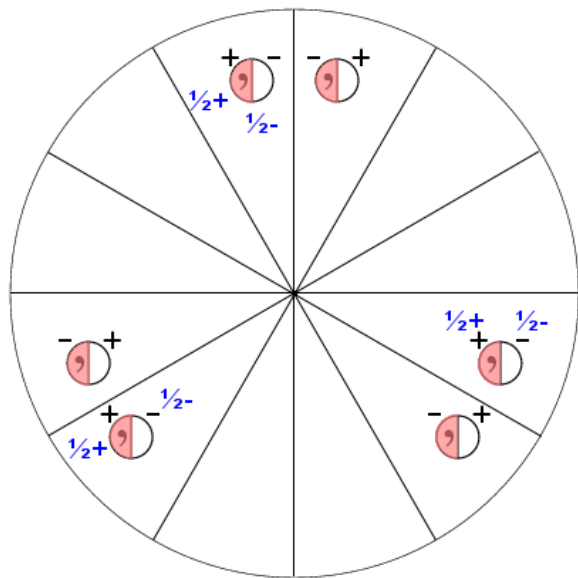
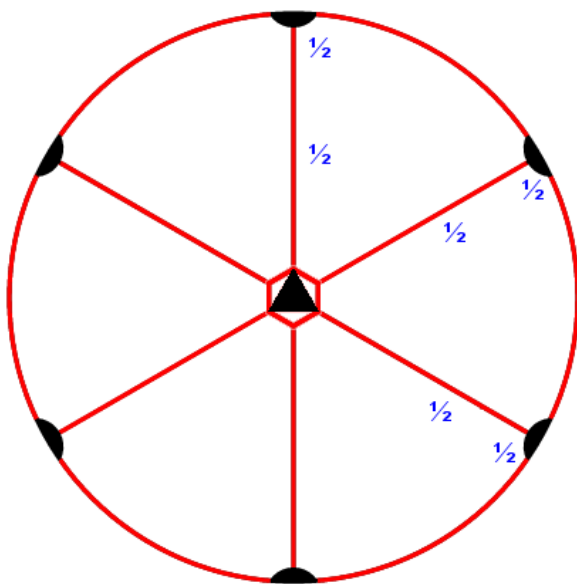

18.2.5.193

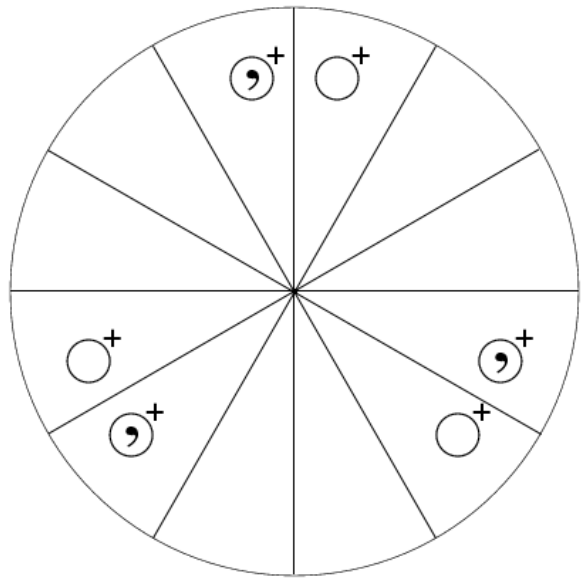
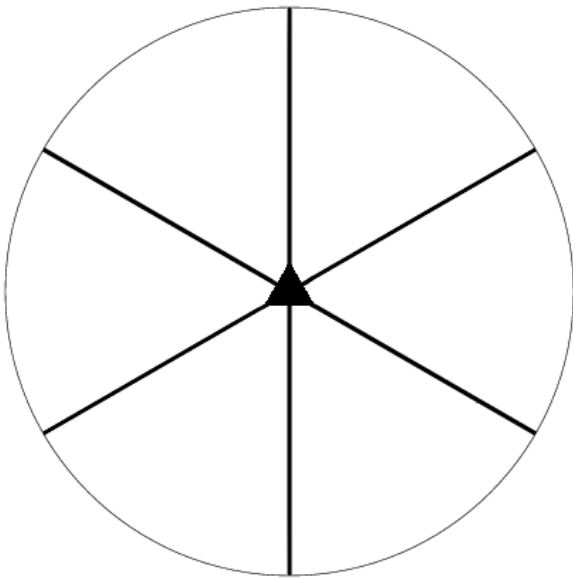

19.1.1.194

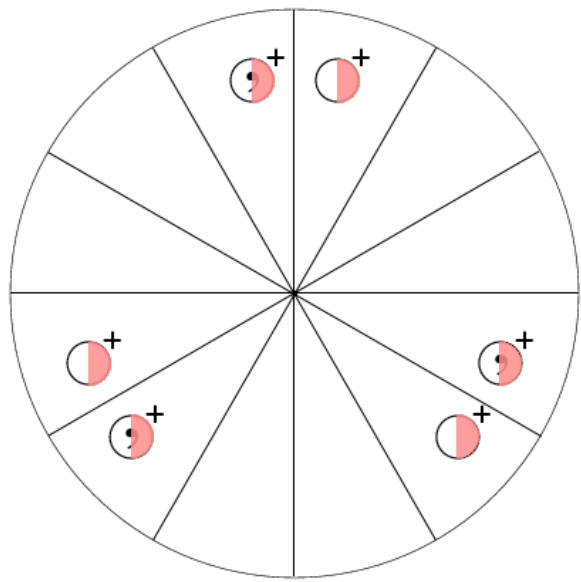
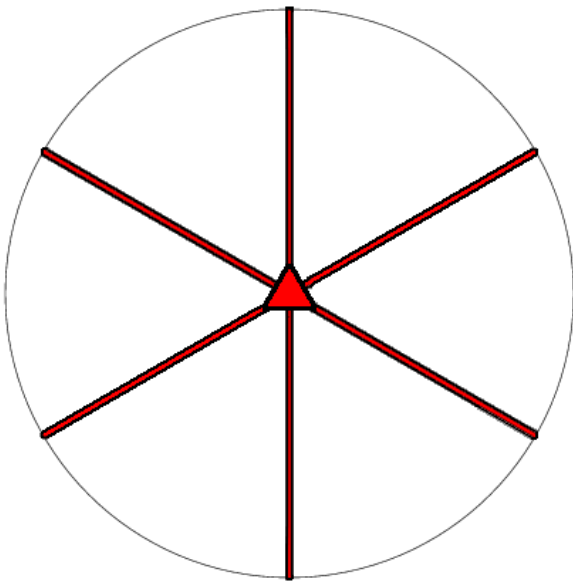

19.1.2.195

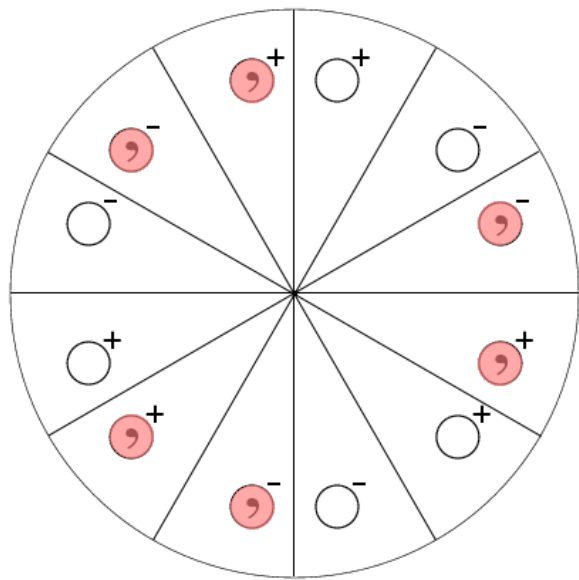
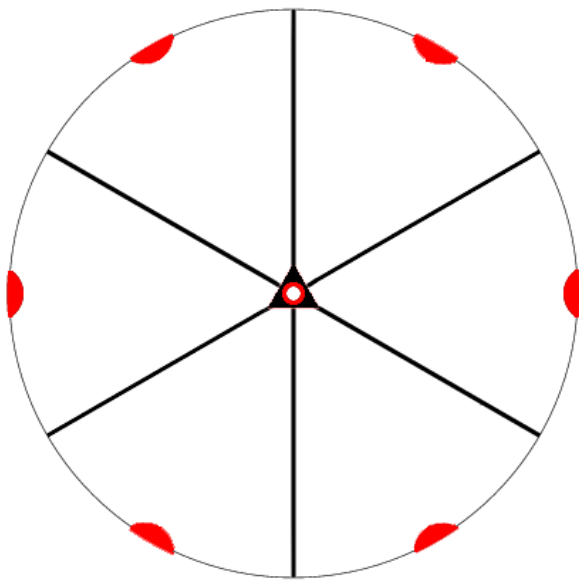

19.1.3.196

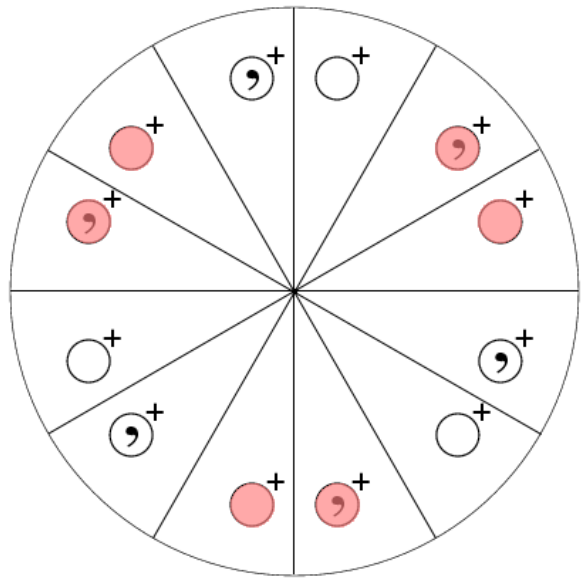
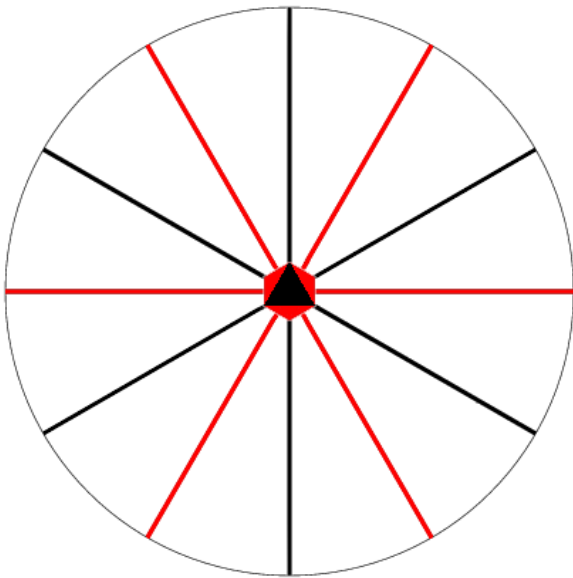

19.1.4.197

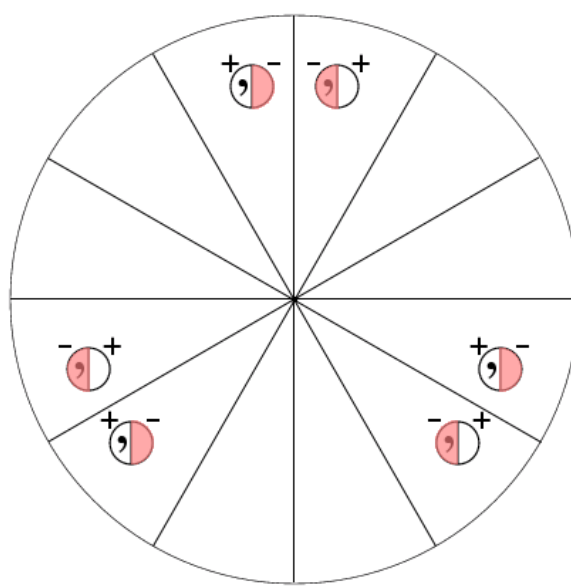
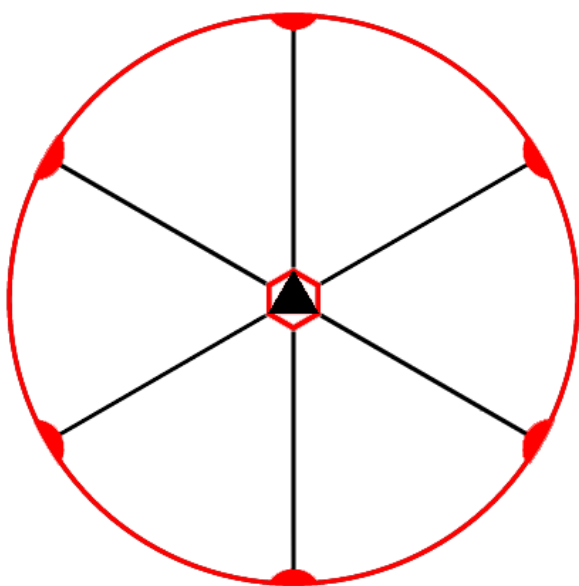

19.1.5.198

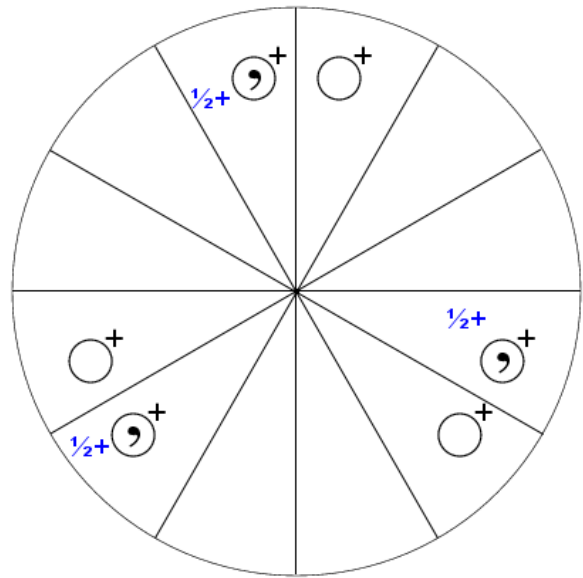
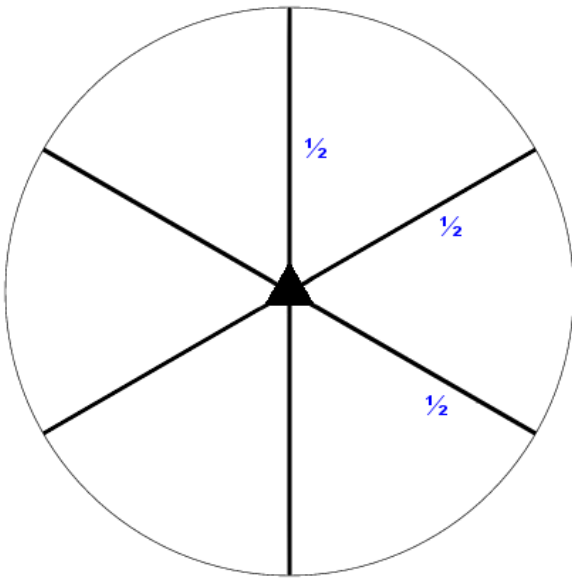

19.2.1.199

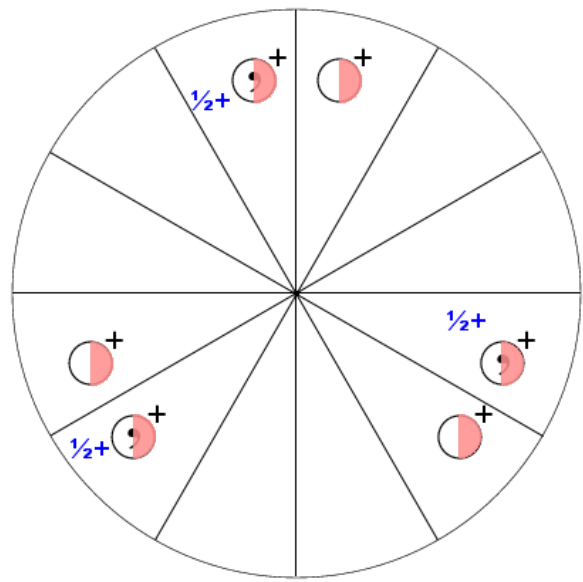
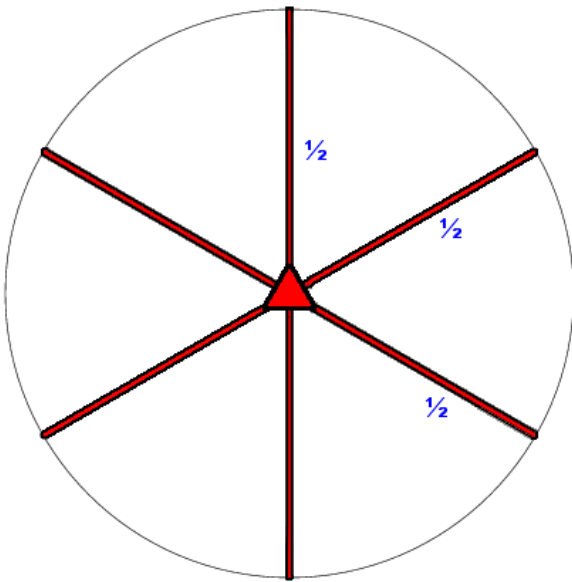

19.2.2.200

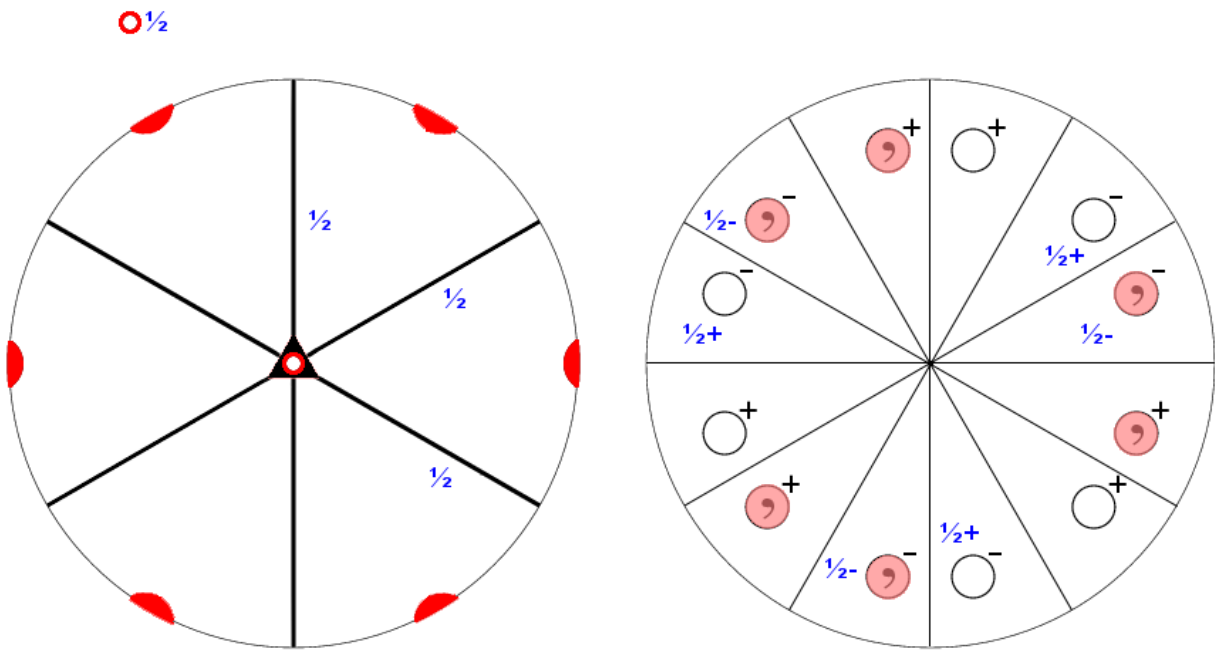

19.2.3.201

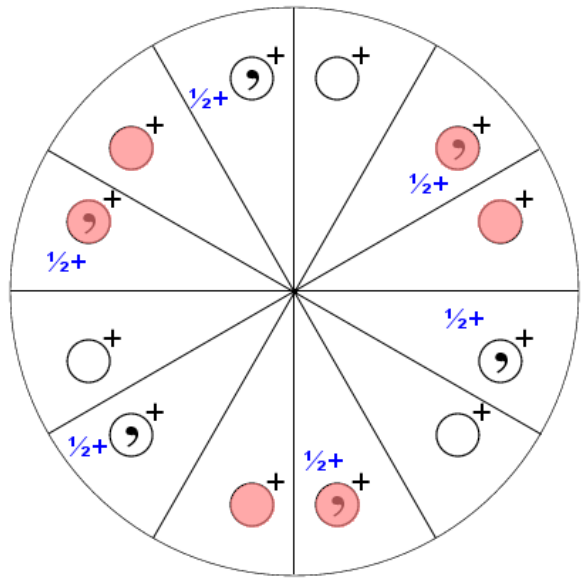
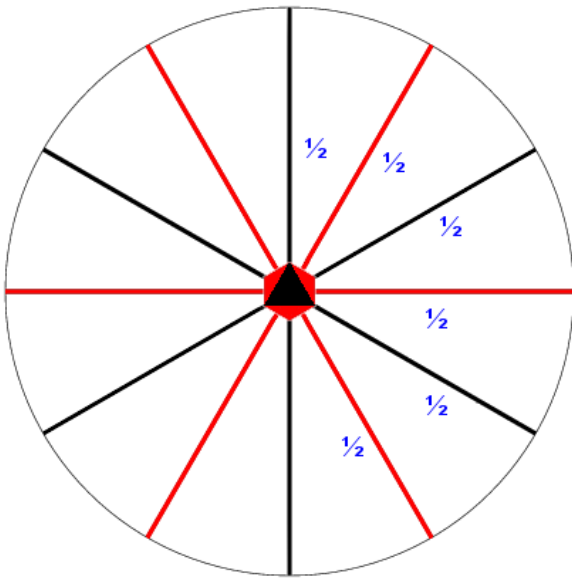

19.2.4.202

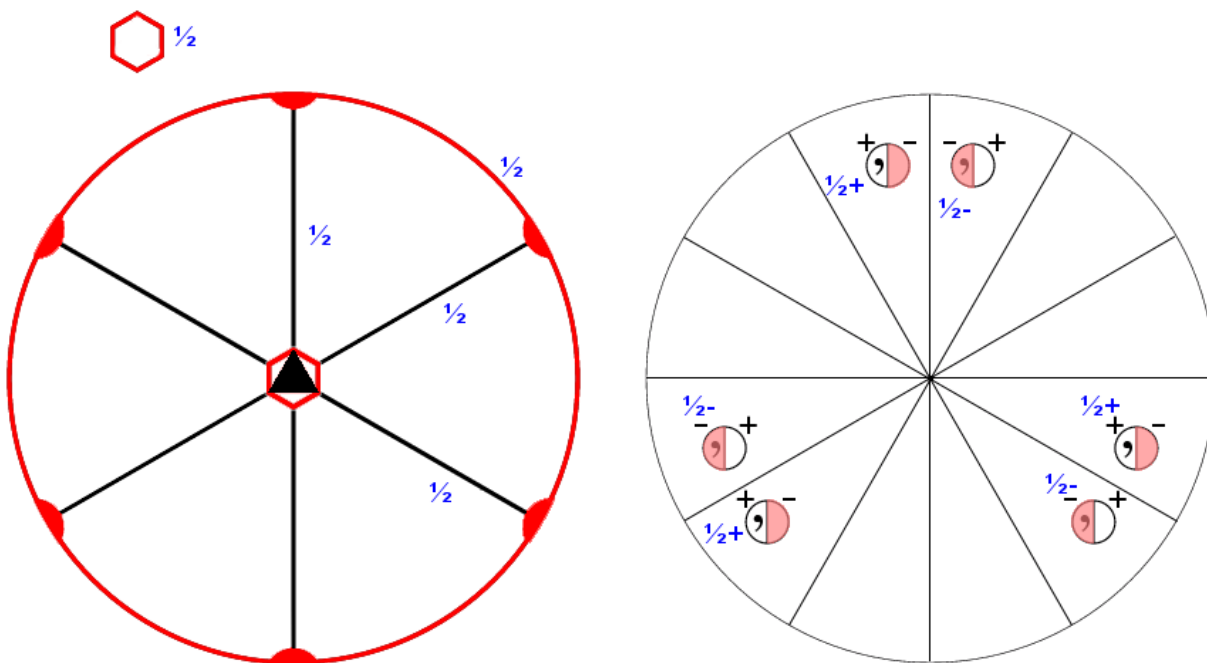

19.2.5.203

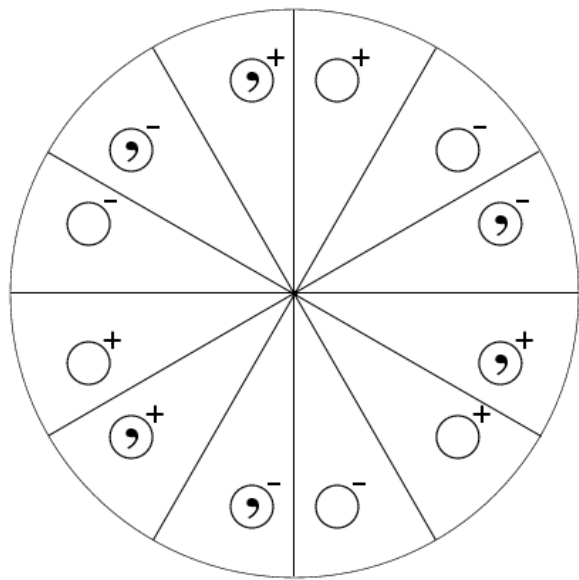
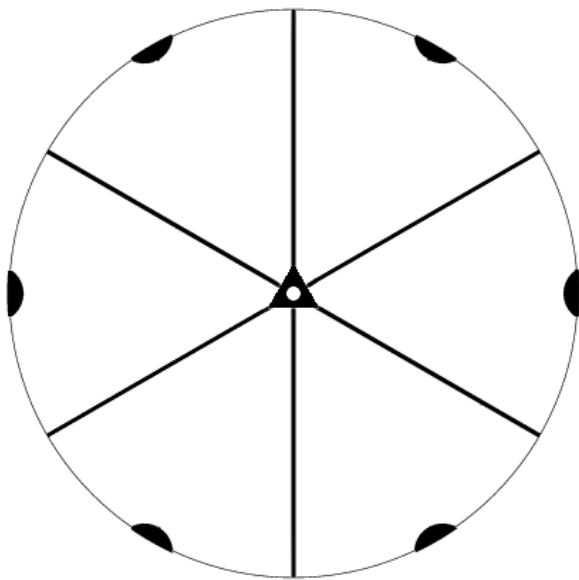

20.1.1.204

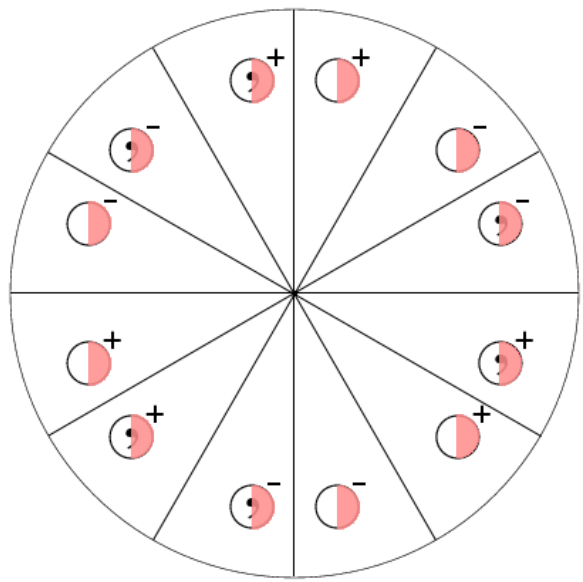
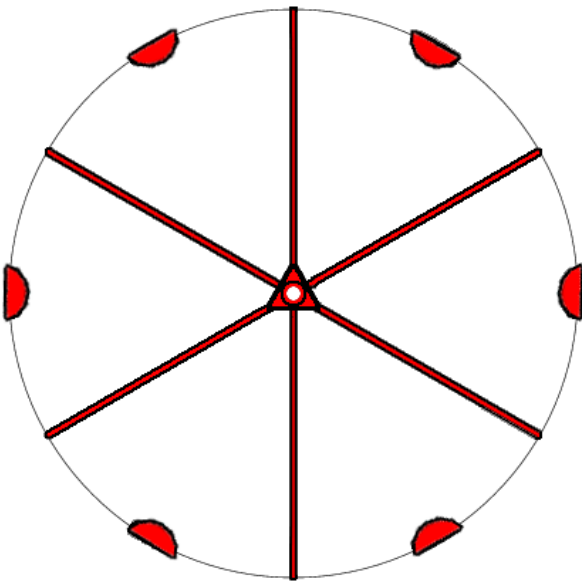

20.1.2.205

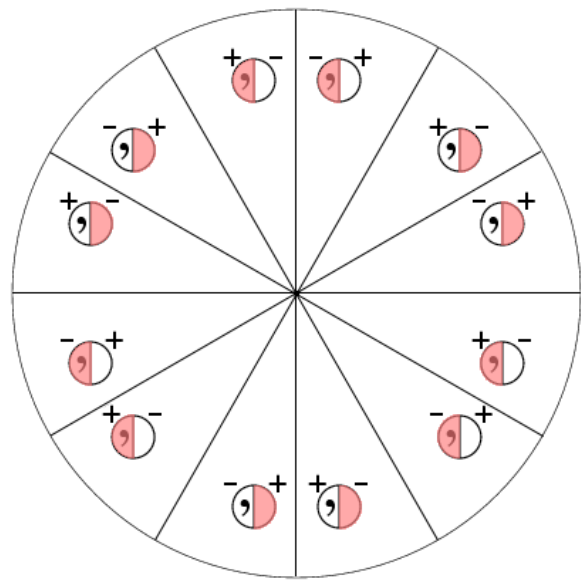
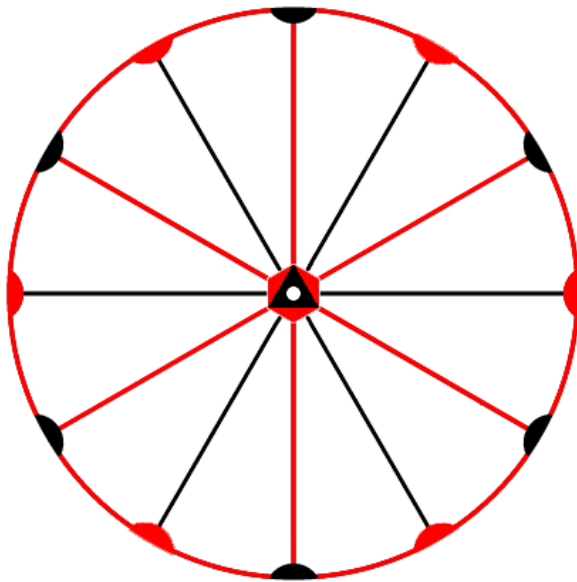

20.1.3.206

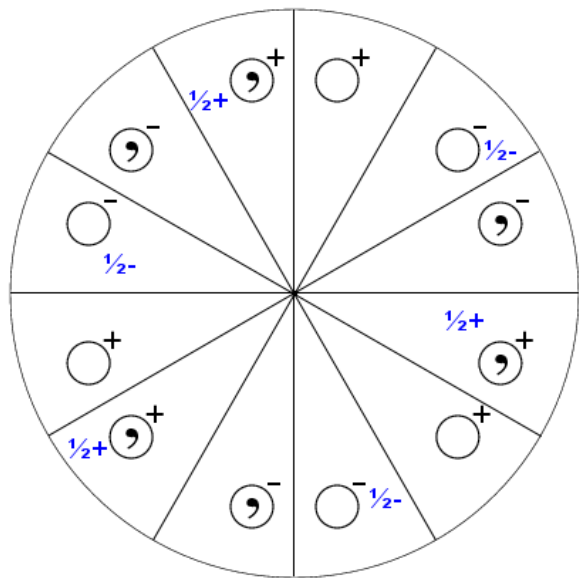
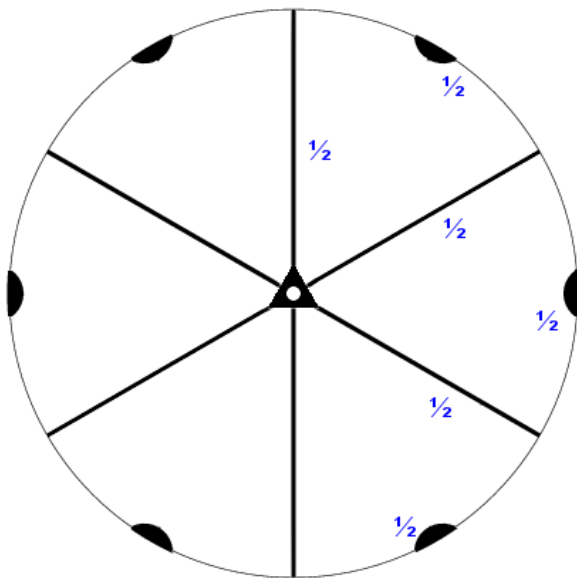

20.2.1.207

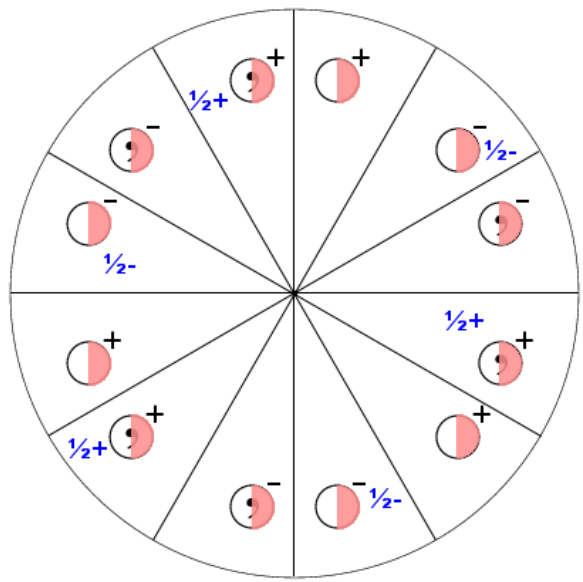
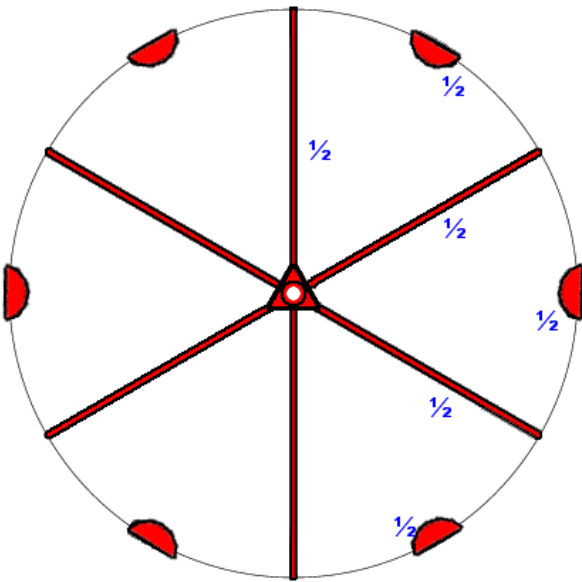

20.2.2.208

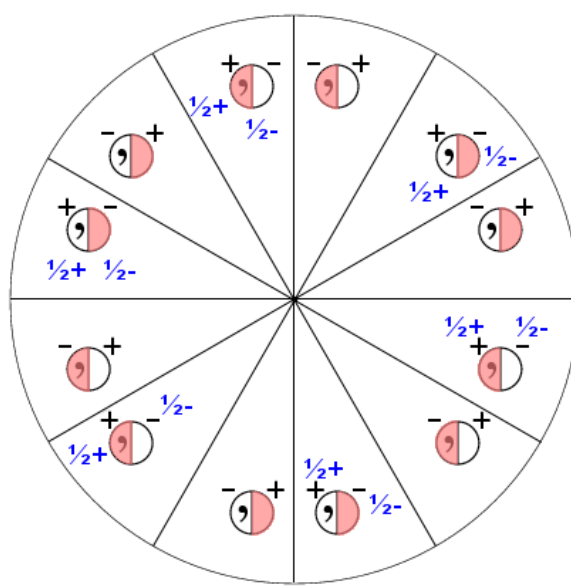
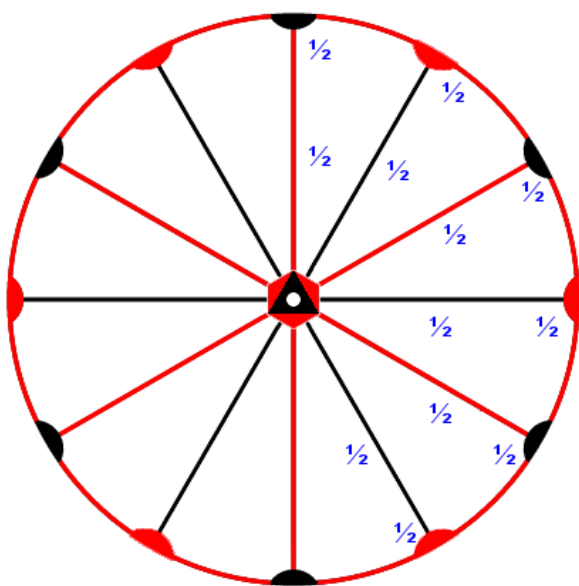

20.2.3.209

$\circ \frac{1}{2}$

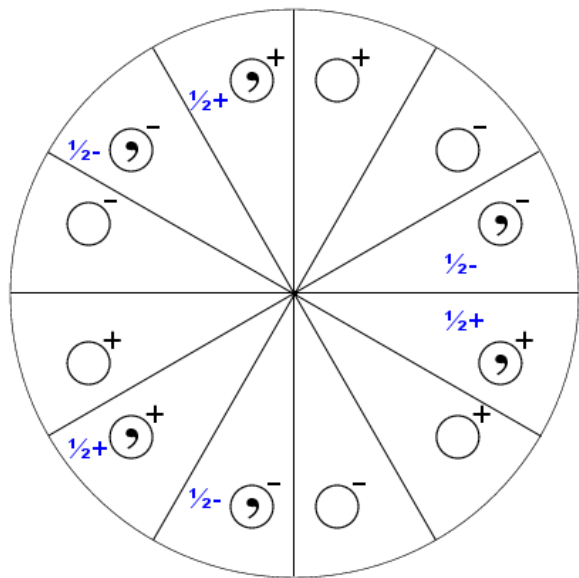
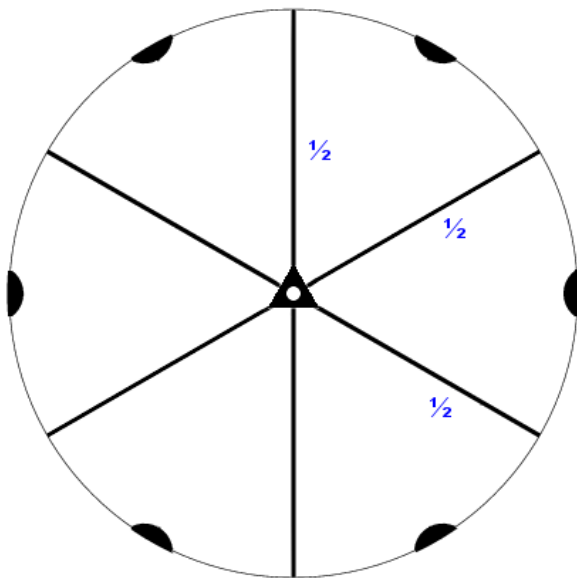

20.3.1.210

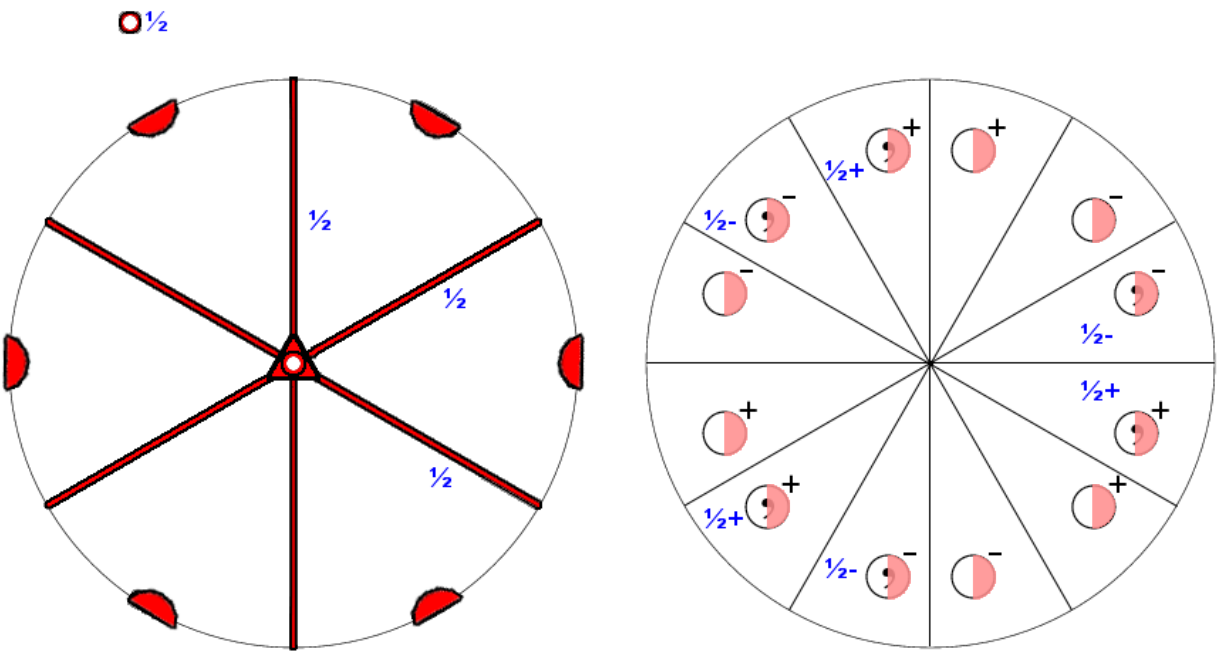

20.3.2.211

$\circ \frac{1}{2}$

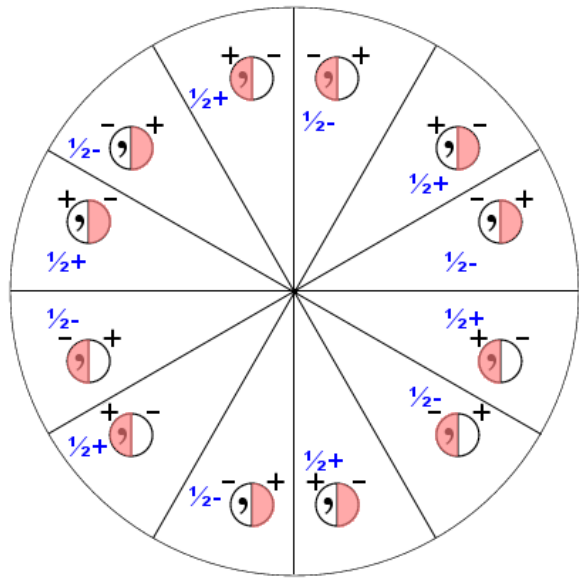
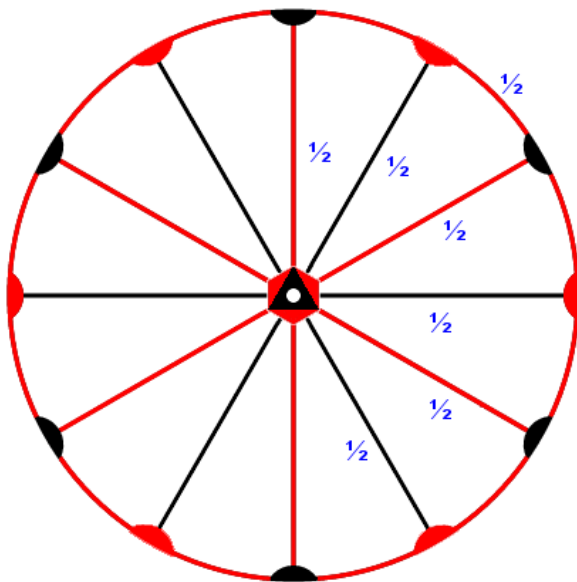

20.3.3.212

$\circ \frac{1}{2}$

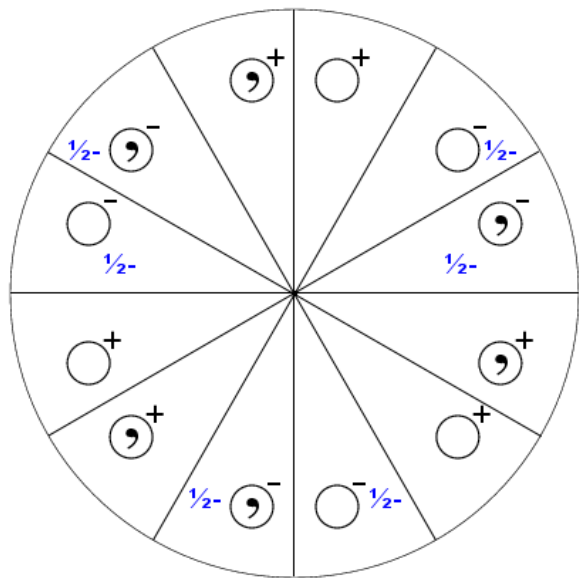
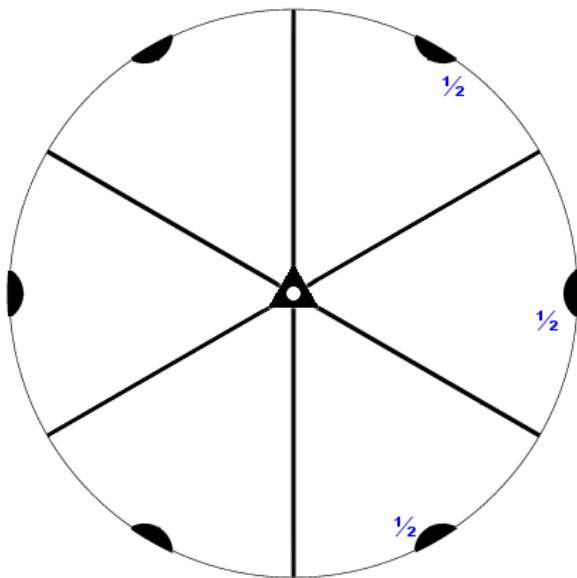

20.4.1.213

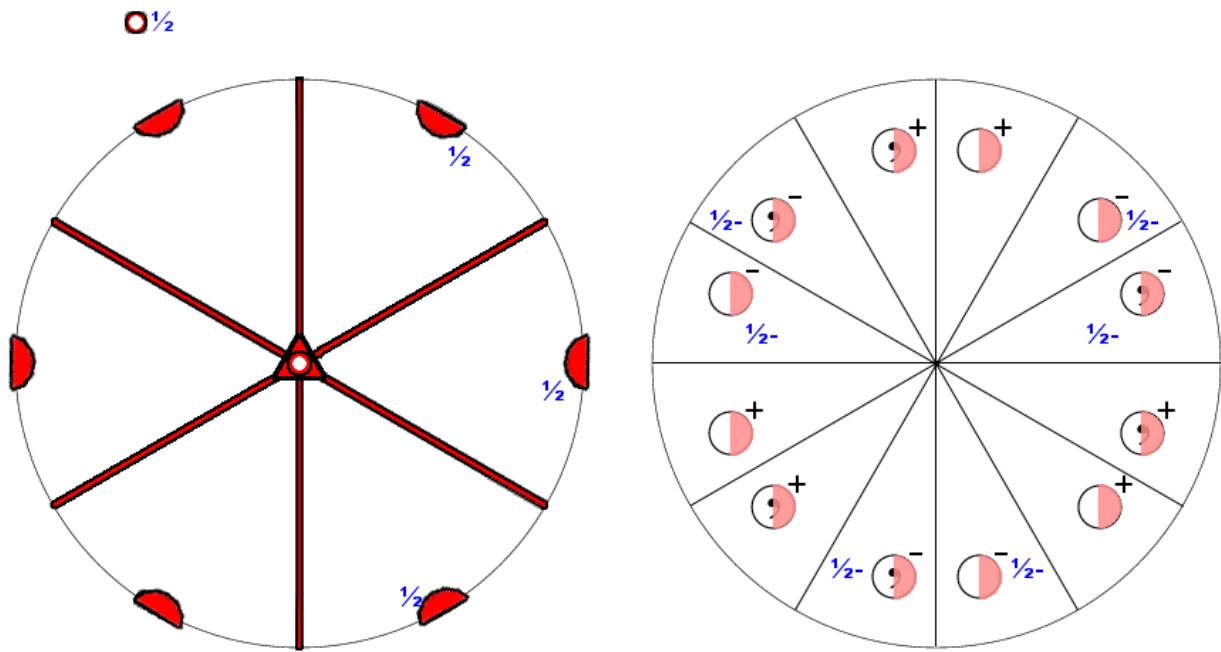

20.4.2.214

$\odot \frac{1}{2}$

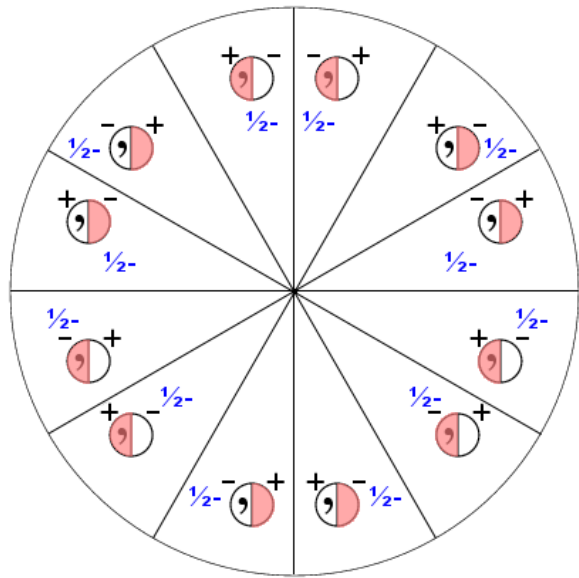
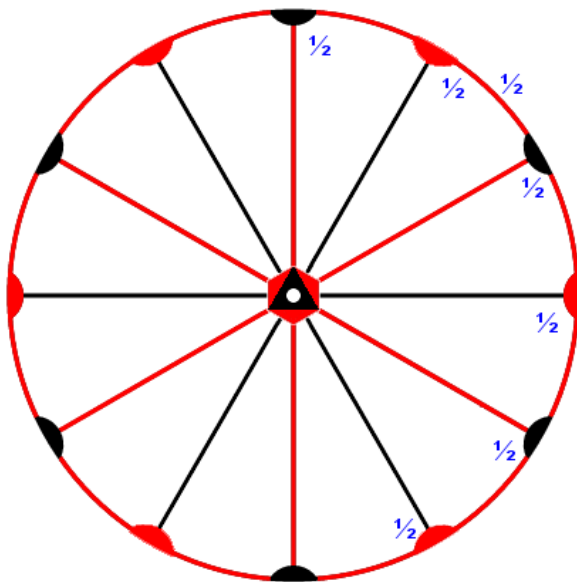

20.4.3.215

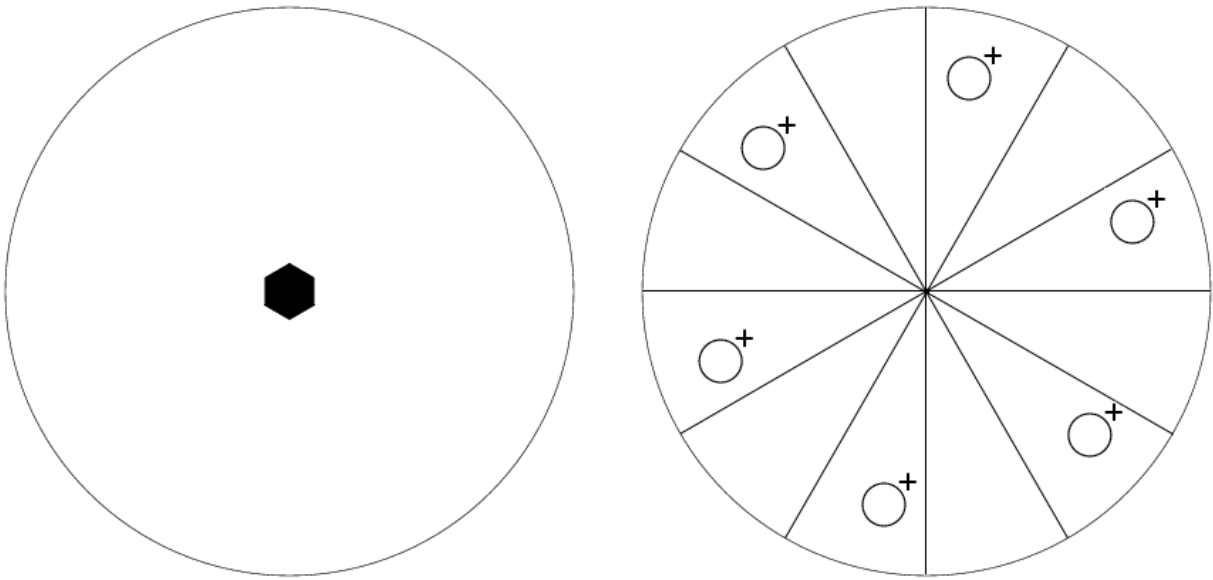

21.1.1.216

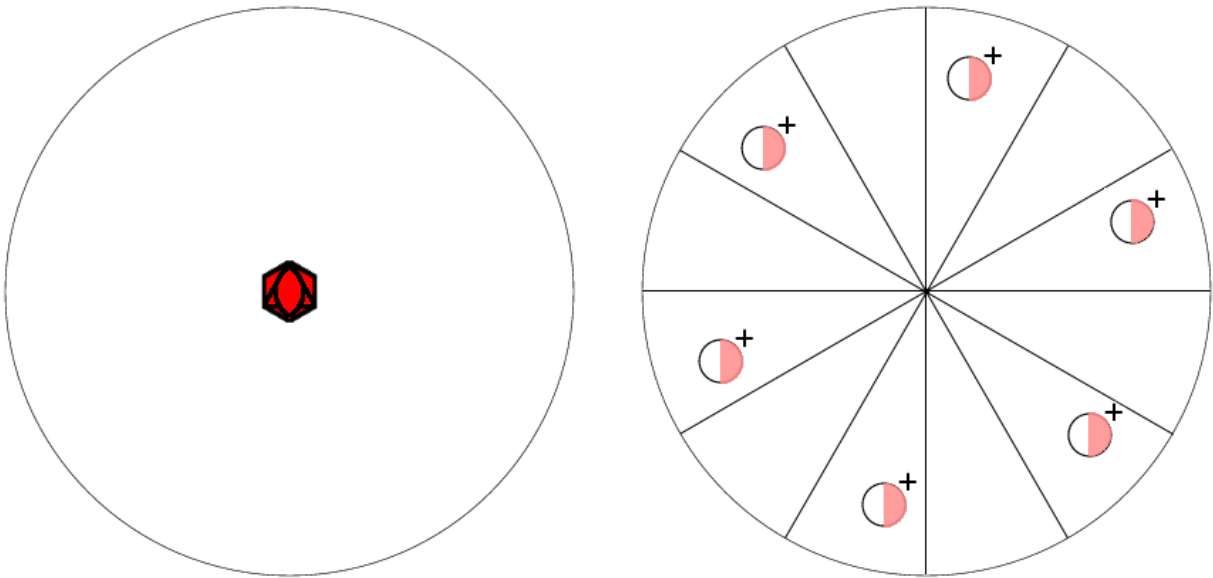

21.1.2.217

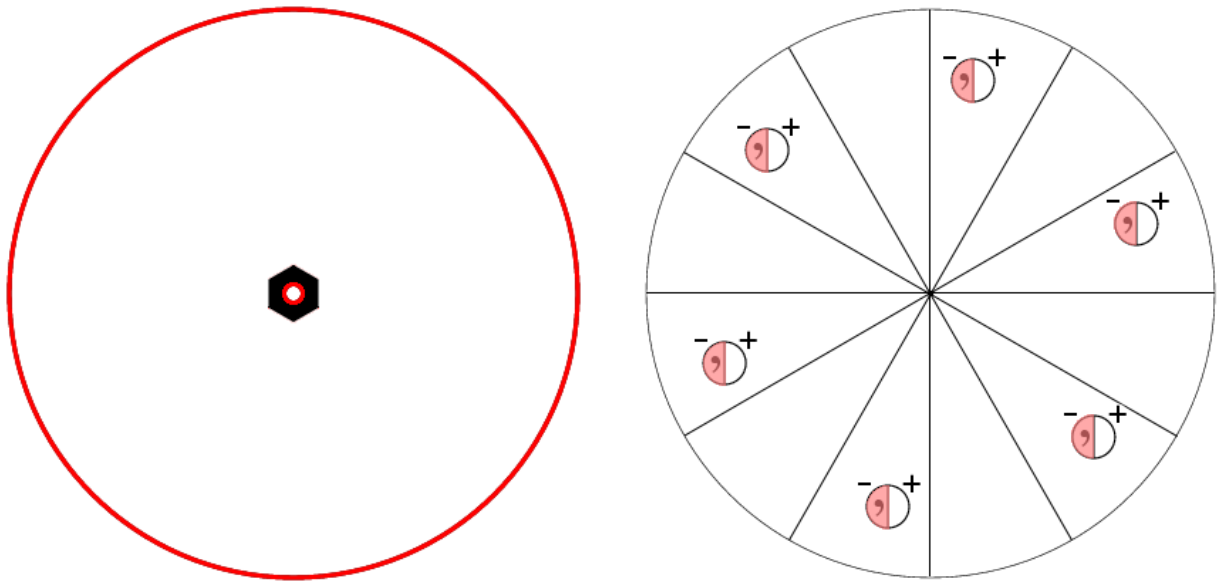

21.1.3.218

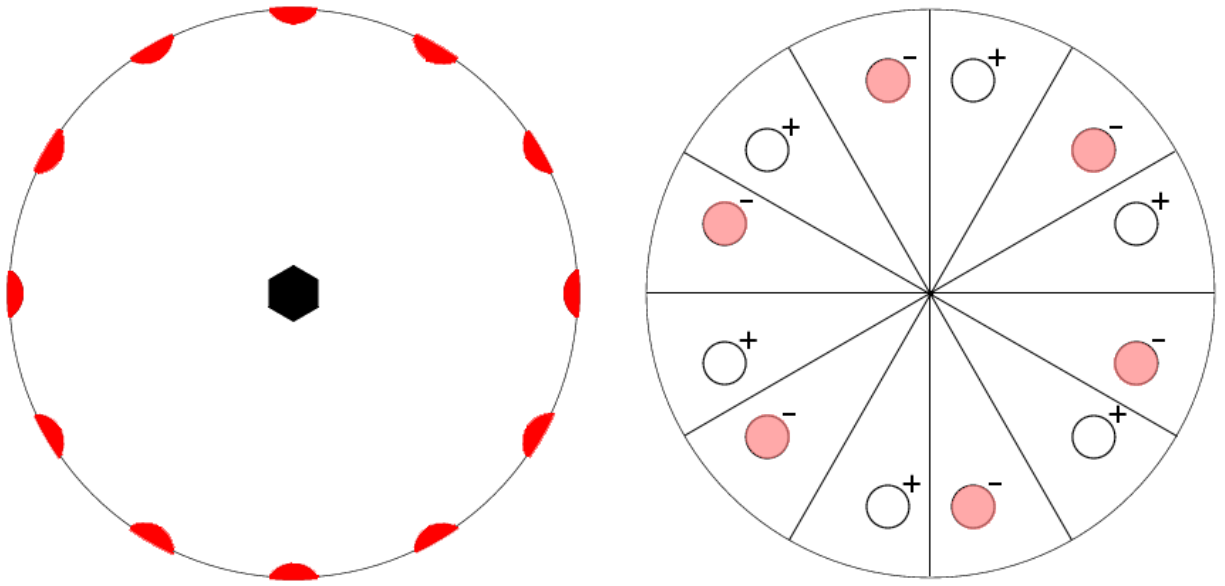

21.1.4.219

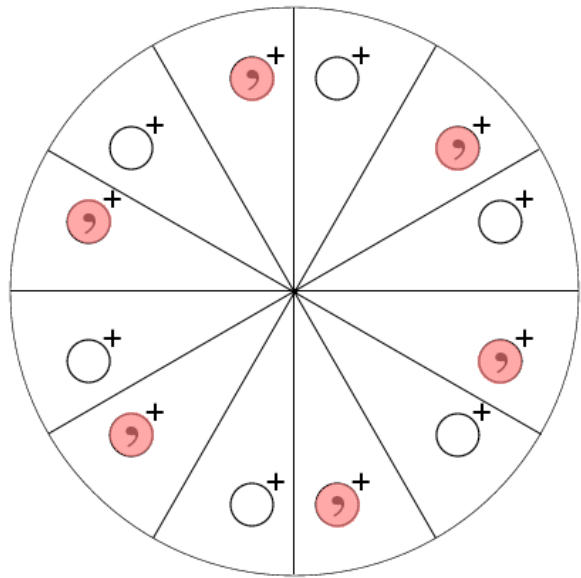
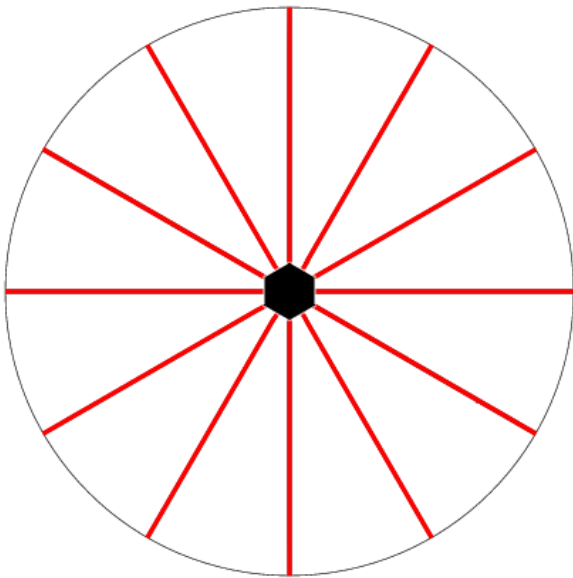

21.1.5.220

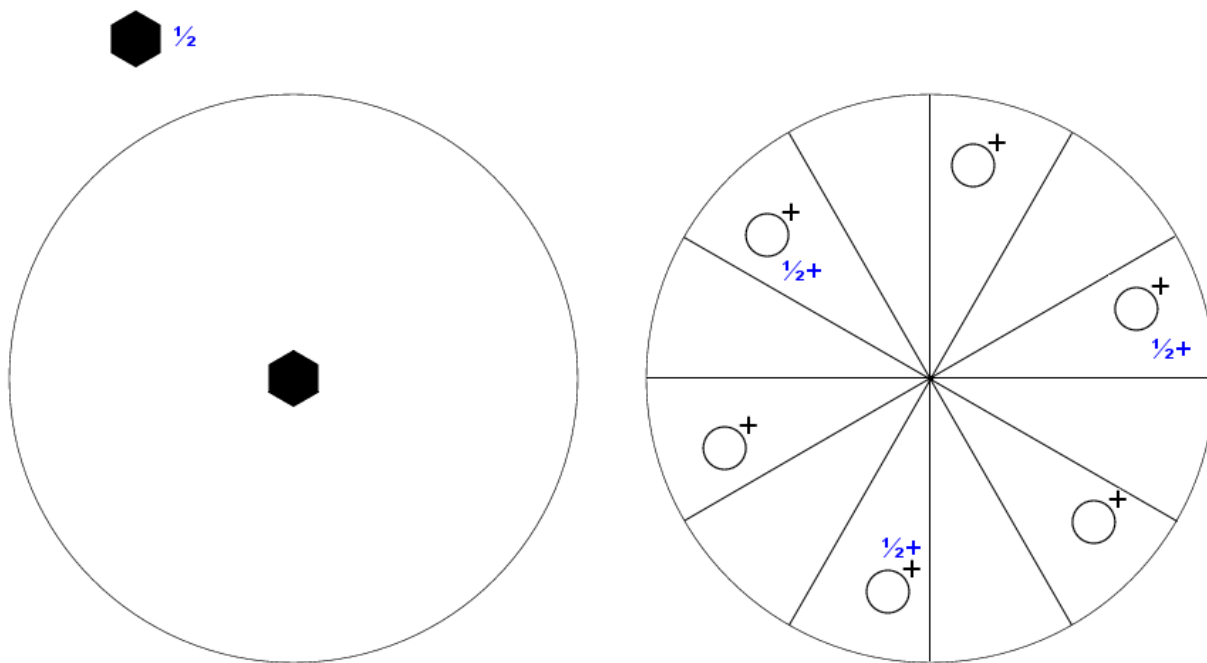

21.2.1.221

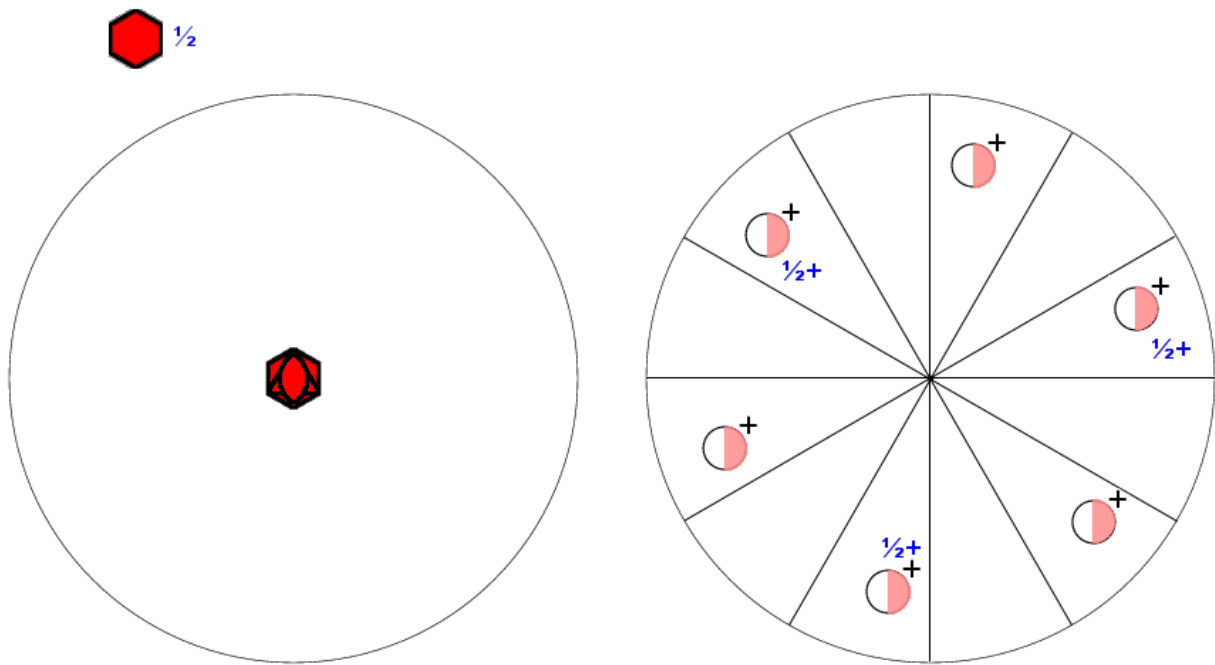

21.2.2.222

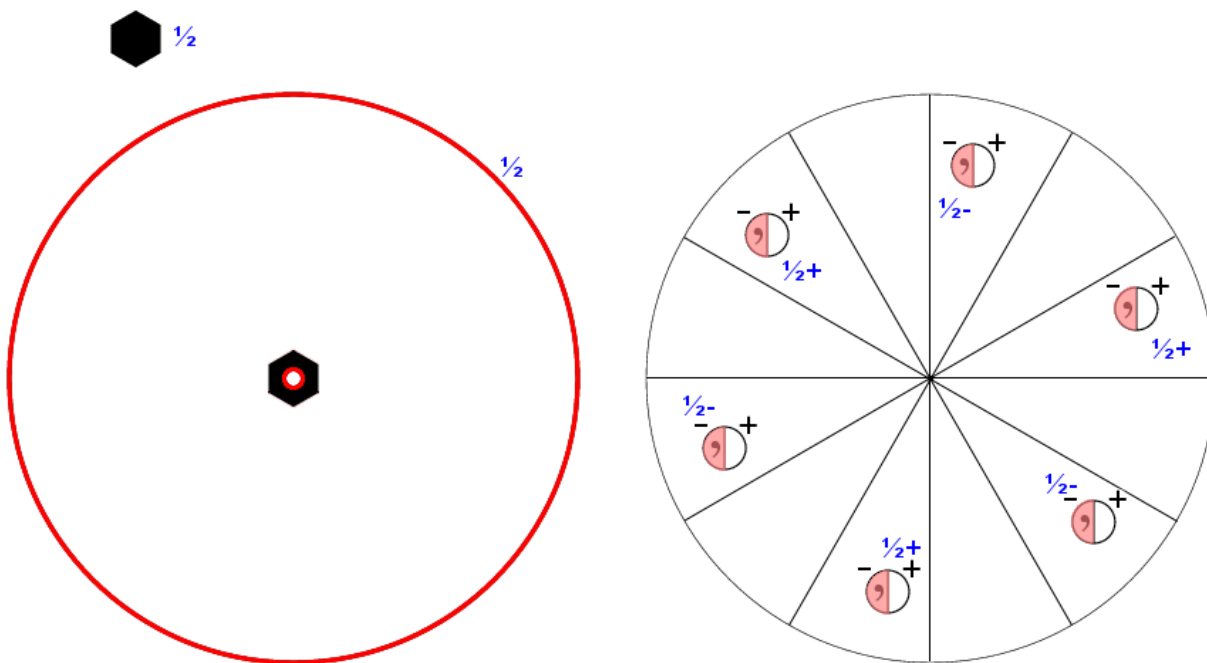

21.2.3.223

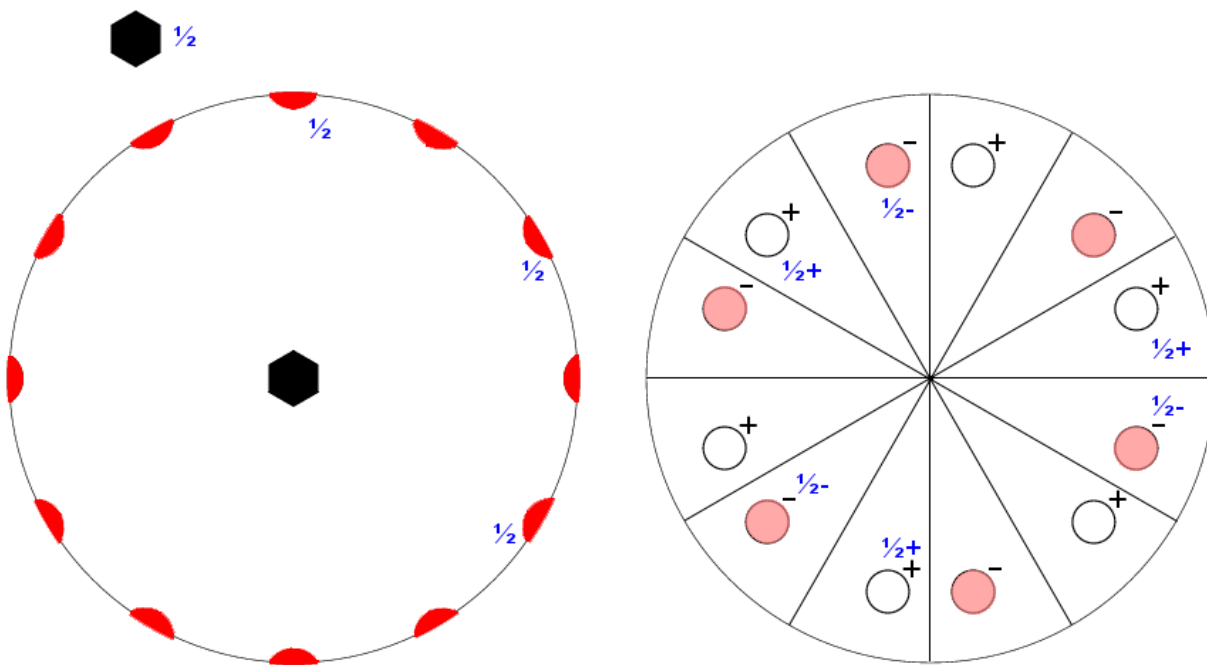

21.2.4.224

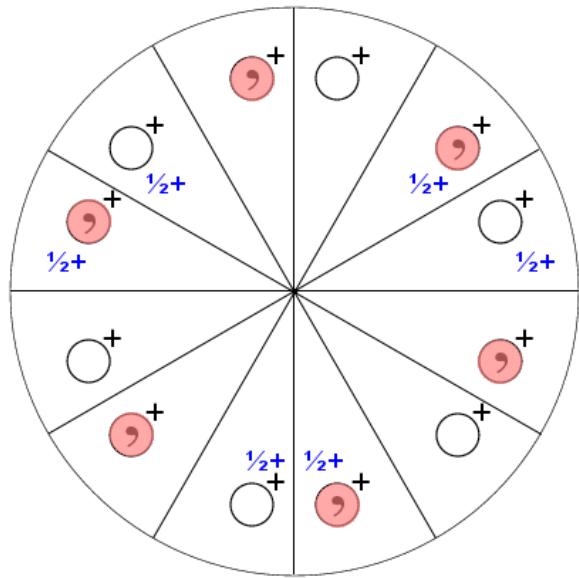
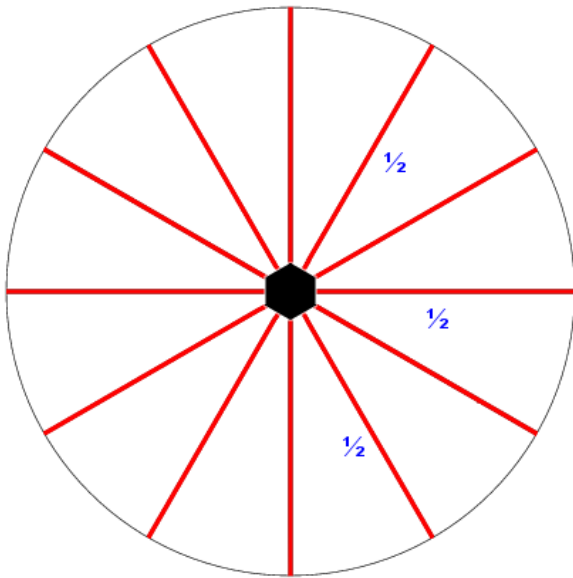

21.2.5.225

⬛ $\frac{2}{3}$ ⬛ $\frac{1}{3}$

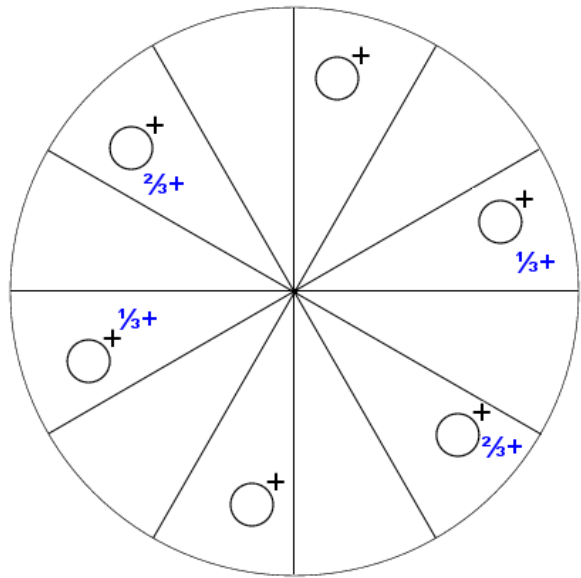
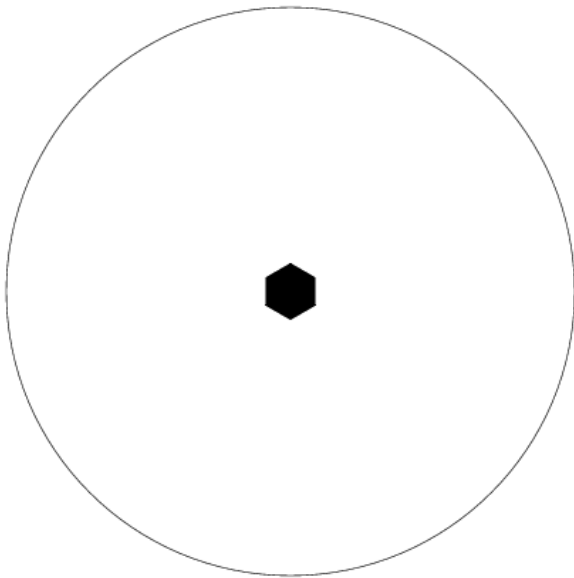

21.3.1.226

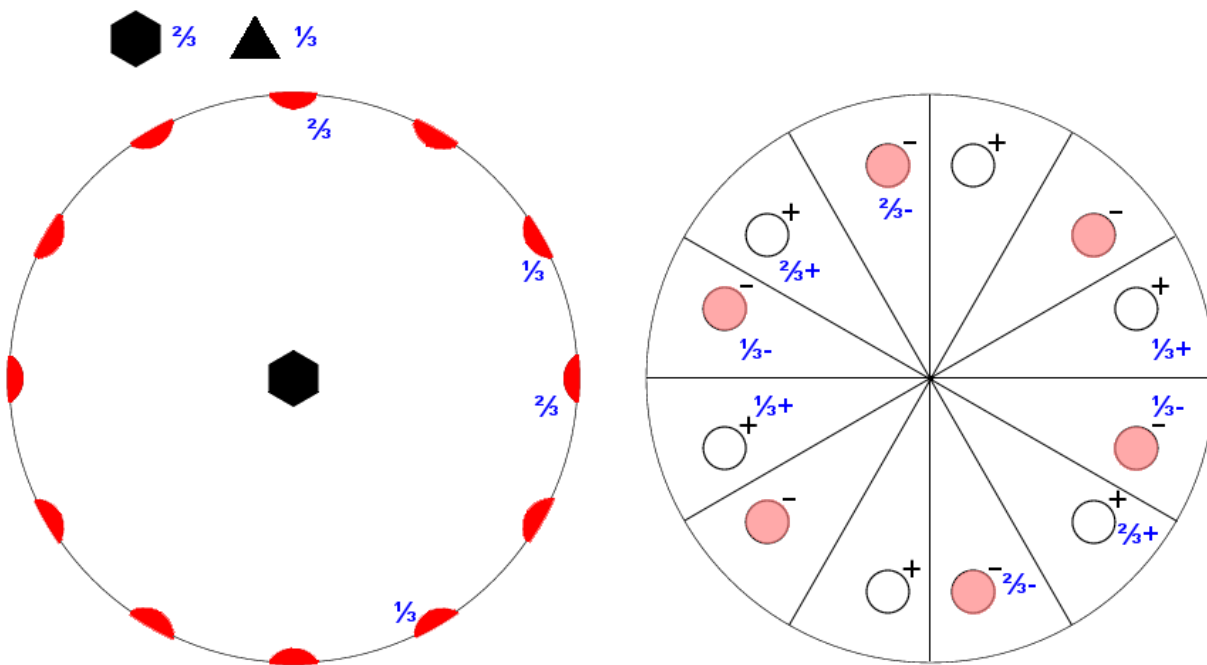

21.3.2.227

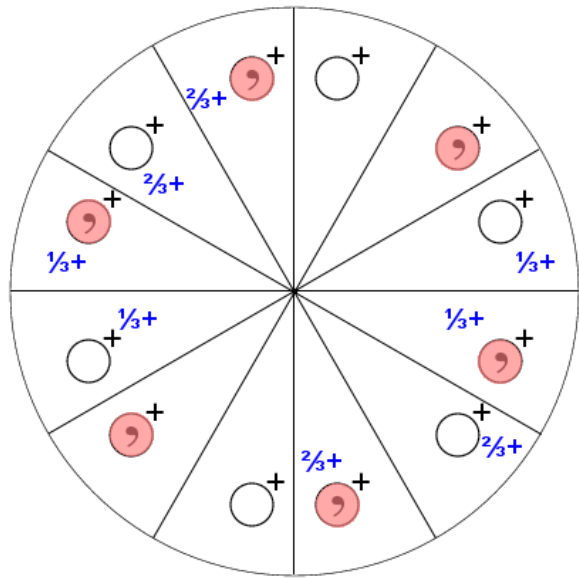
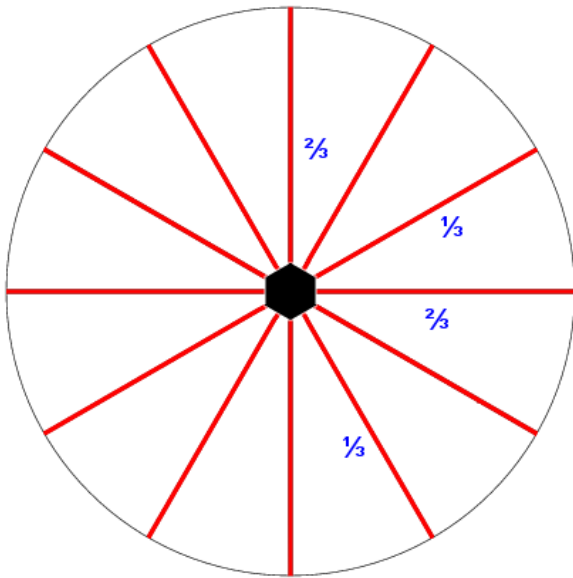
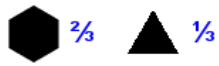

21.3.3.228

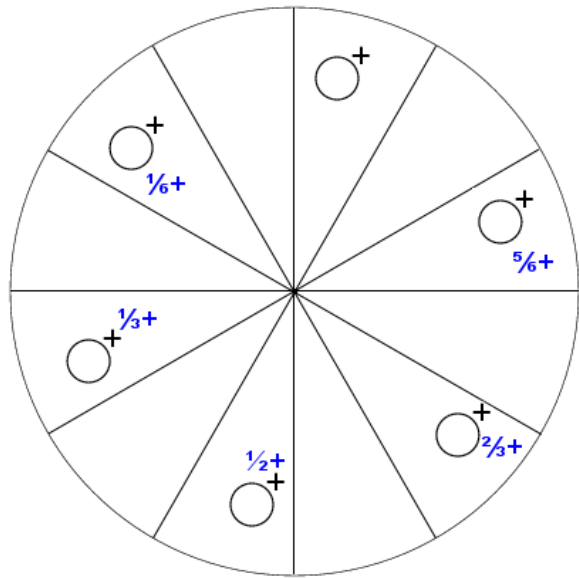
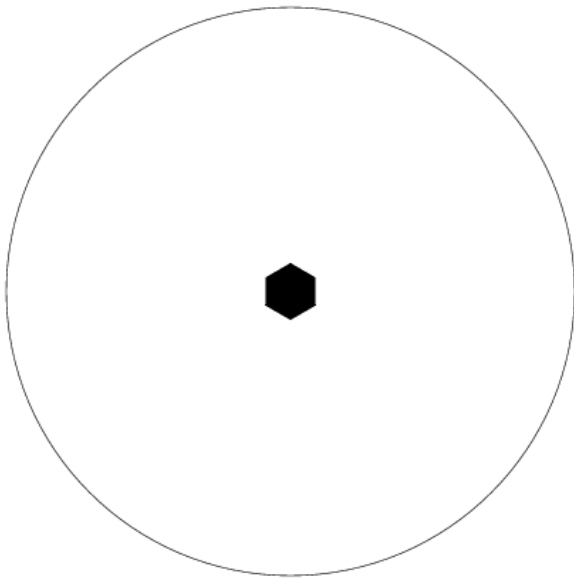

● $\frac{1}{6}$ ▲ $\frac{1}{3}$

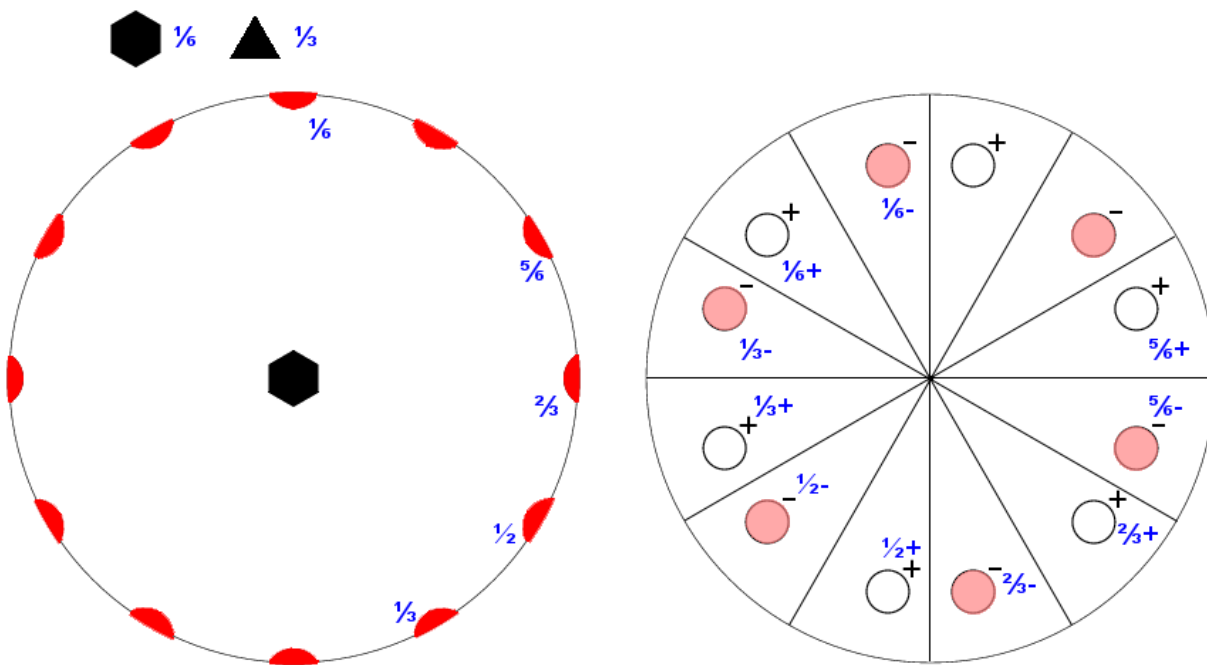

21.4.1.229



21.4.2.230

 $\frac{1}{6}$
 $\frac{1}{3}$

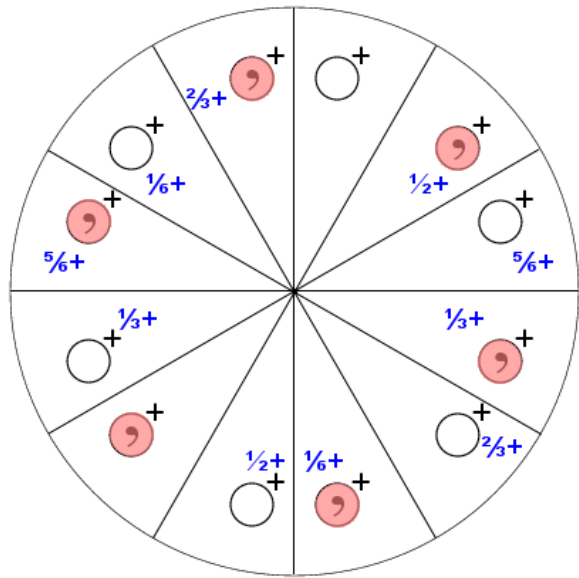
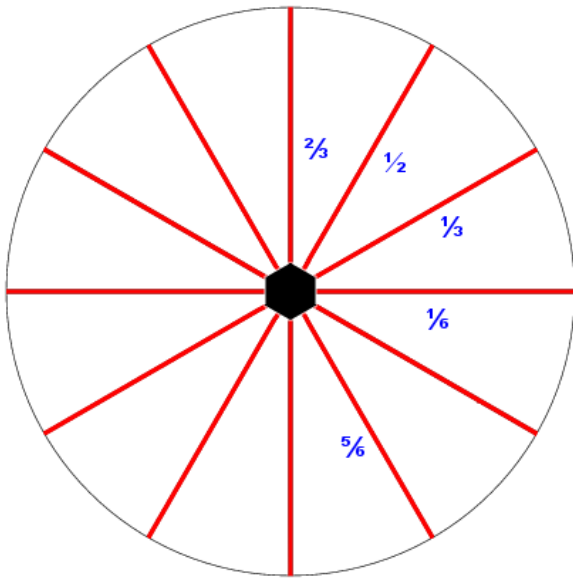

21.4.3.231

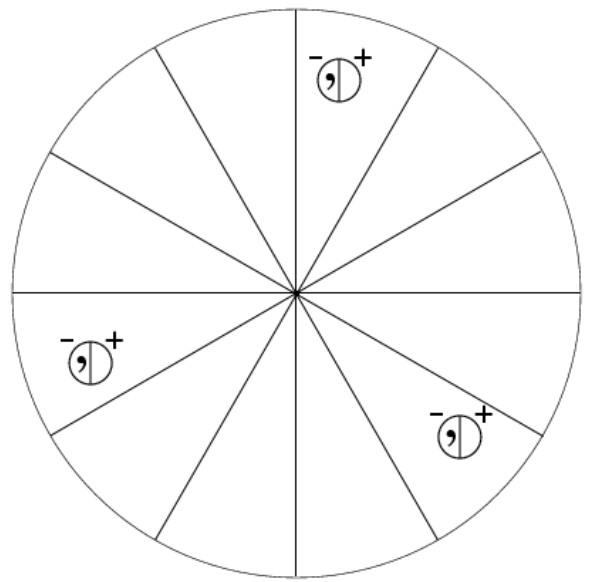
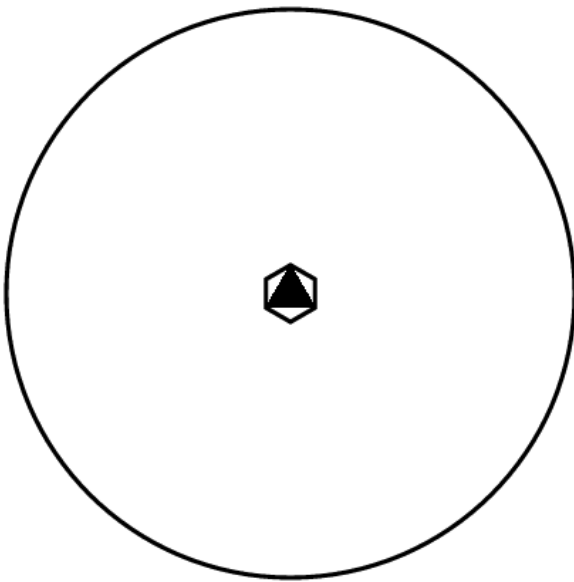

22.1.1.232

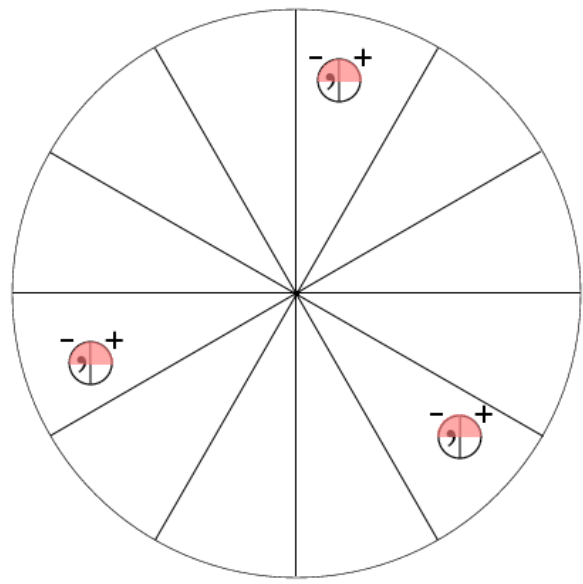
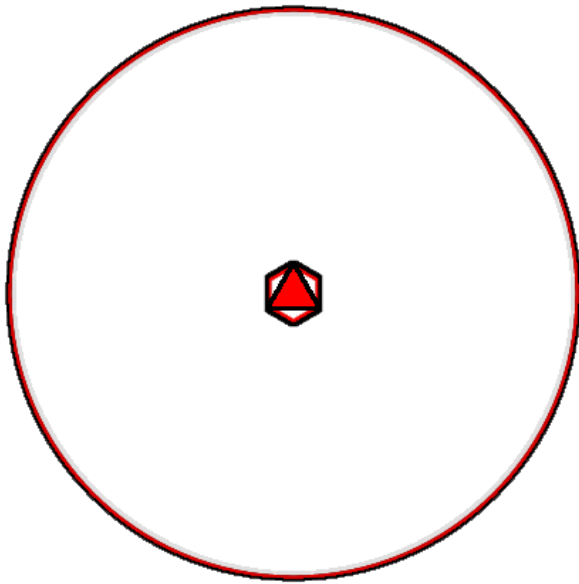

22.1.2.233

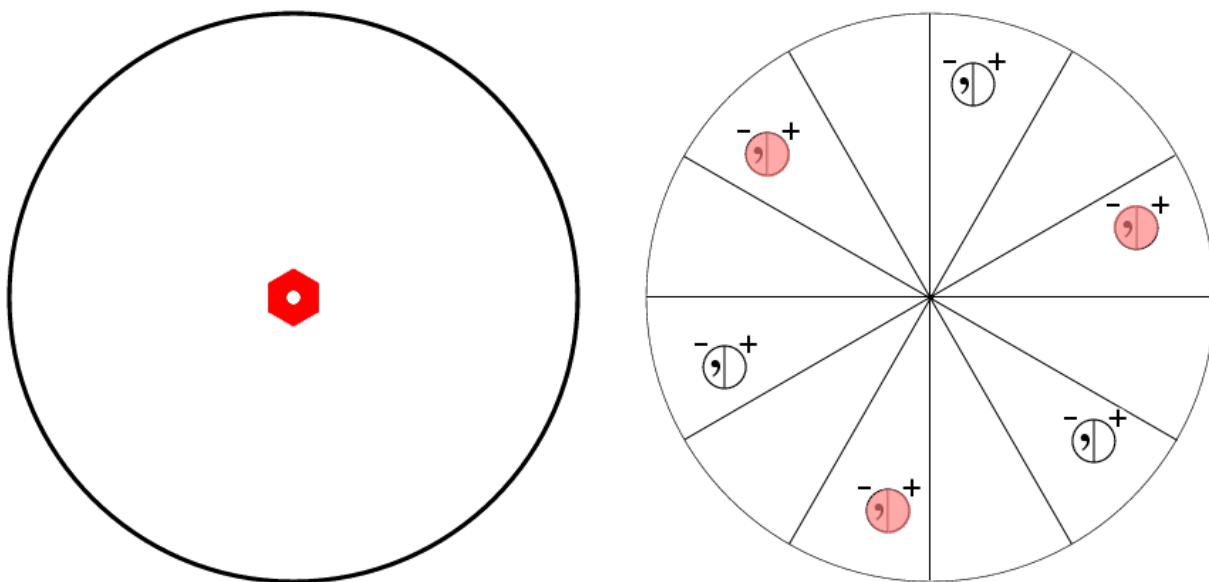

22.1.3.234

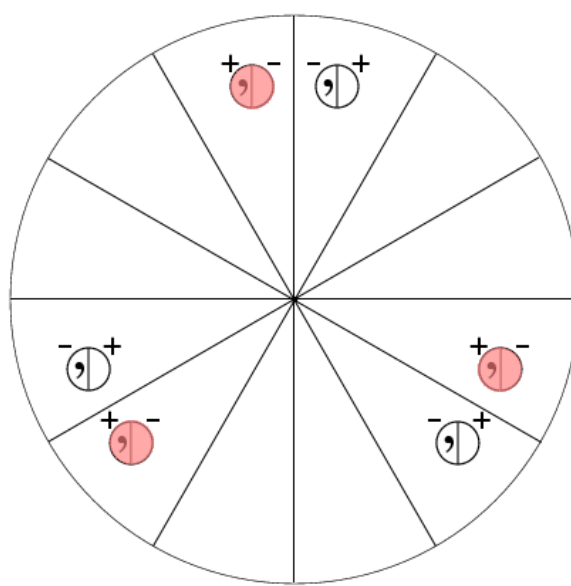
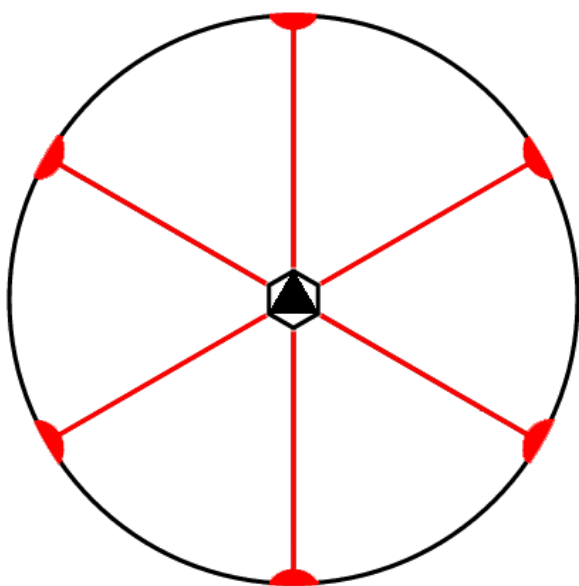

22.1.4.235

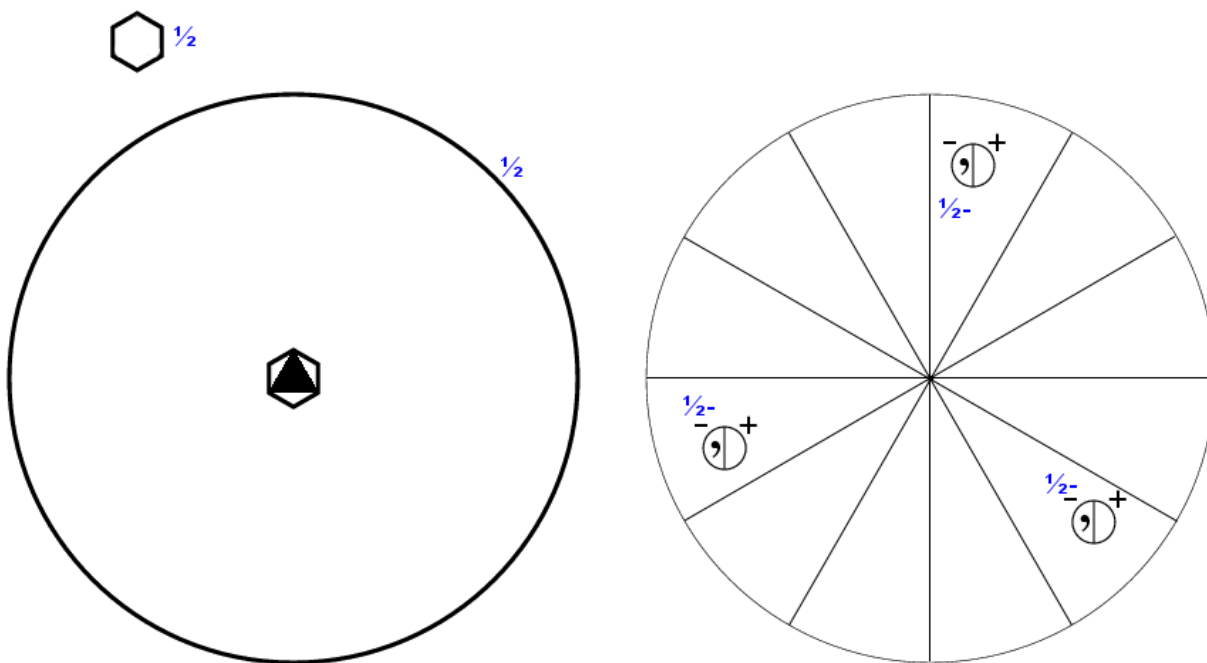

22.2.1.236

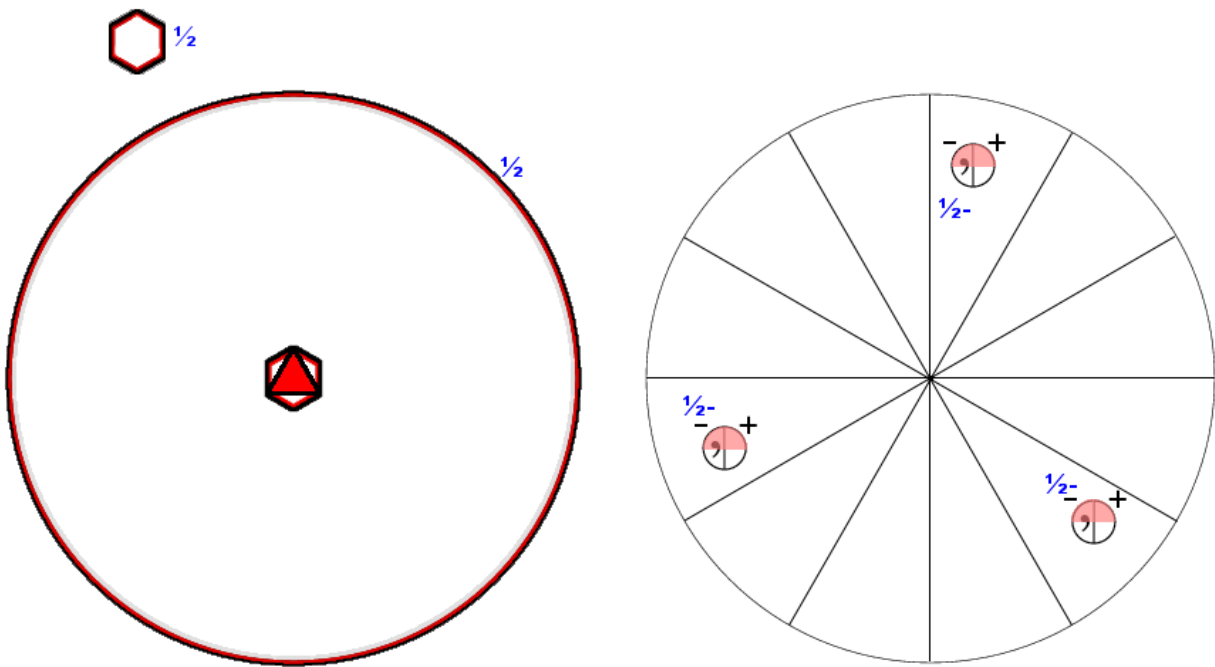

22.2.2.237

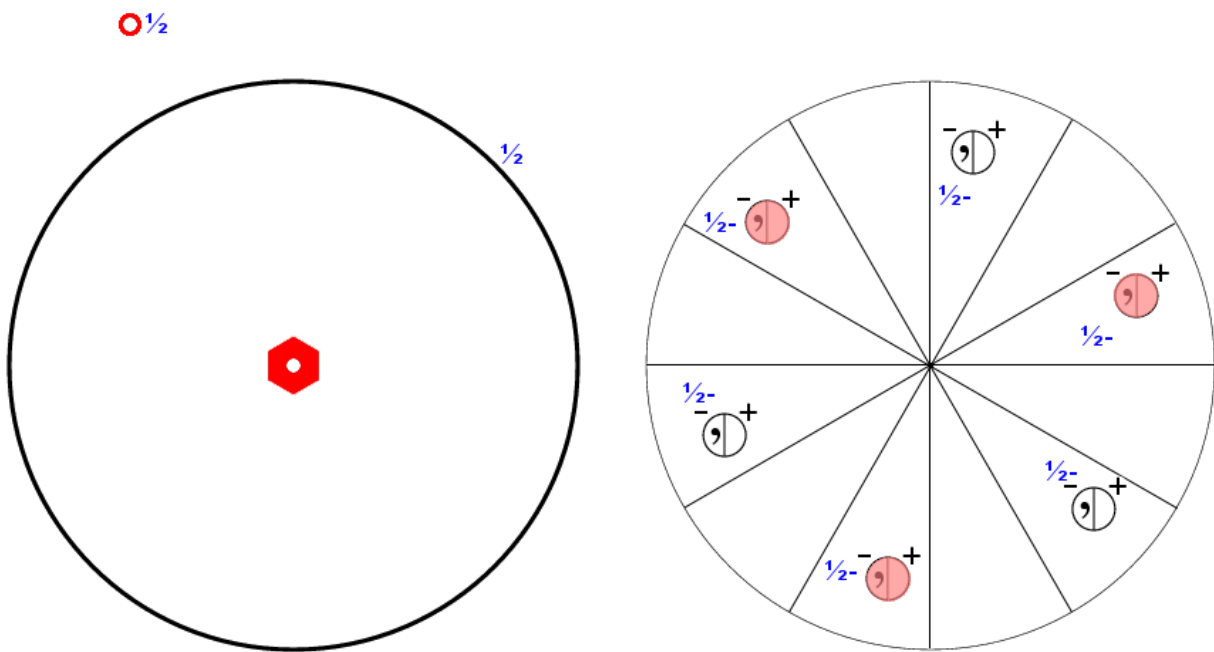

22.2.3.238

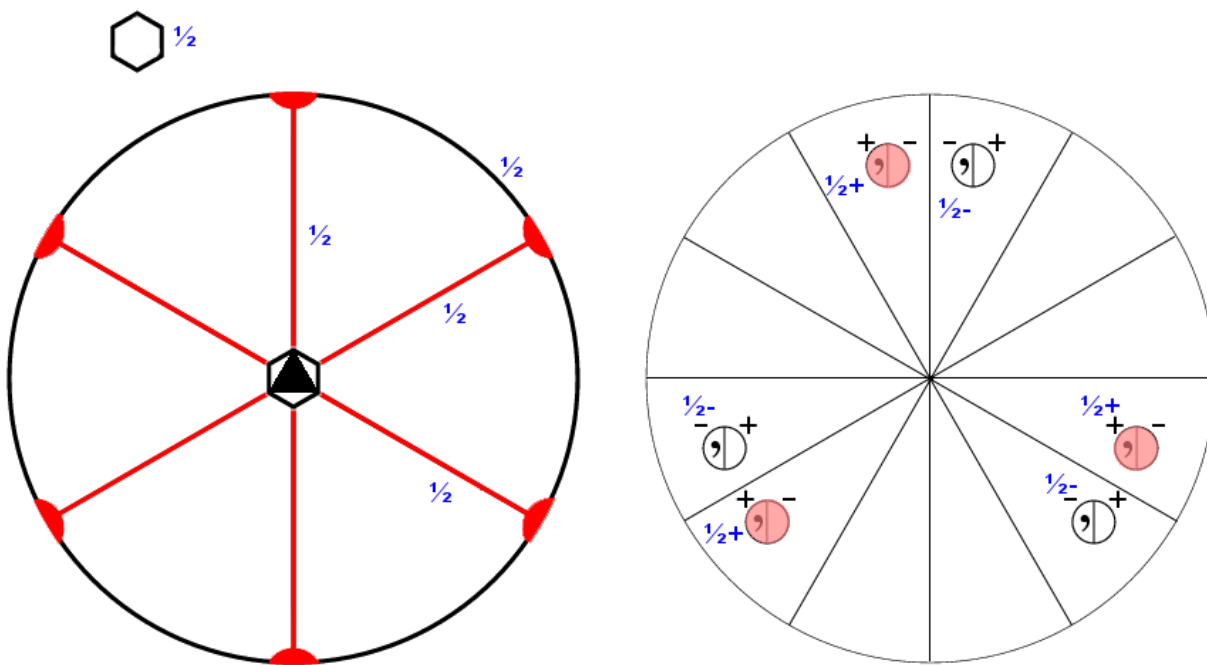

22.2.4.239

⬡ $\frac{2}{3}$ ▲ $\frac{1}{3}$

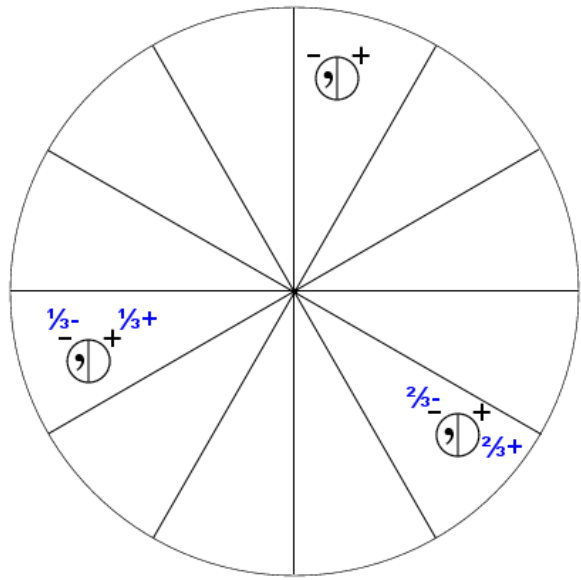
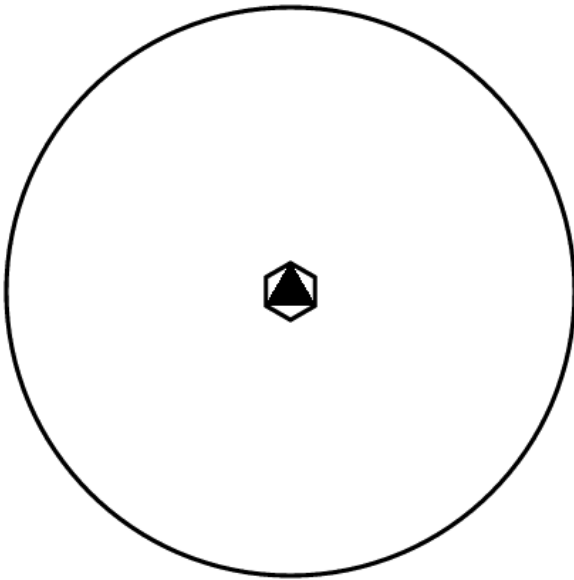

22.3.1.240

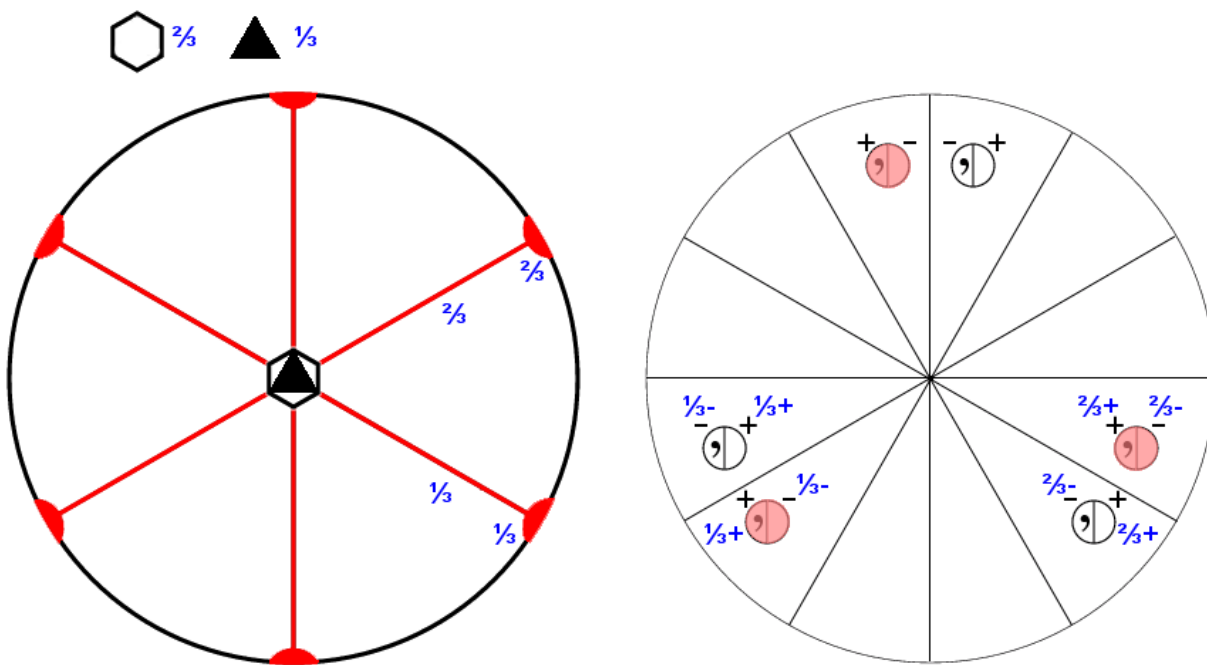

22.3.2.241

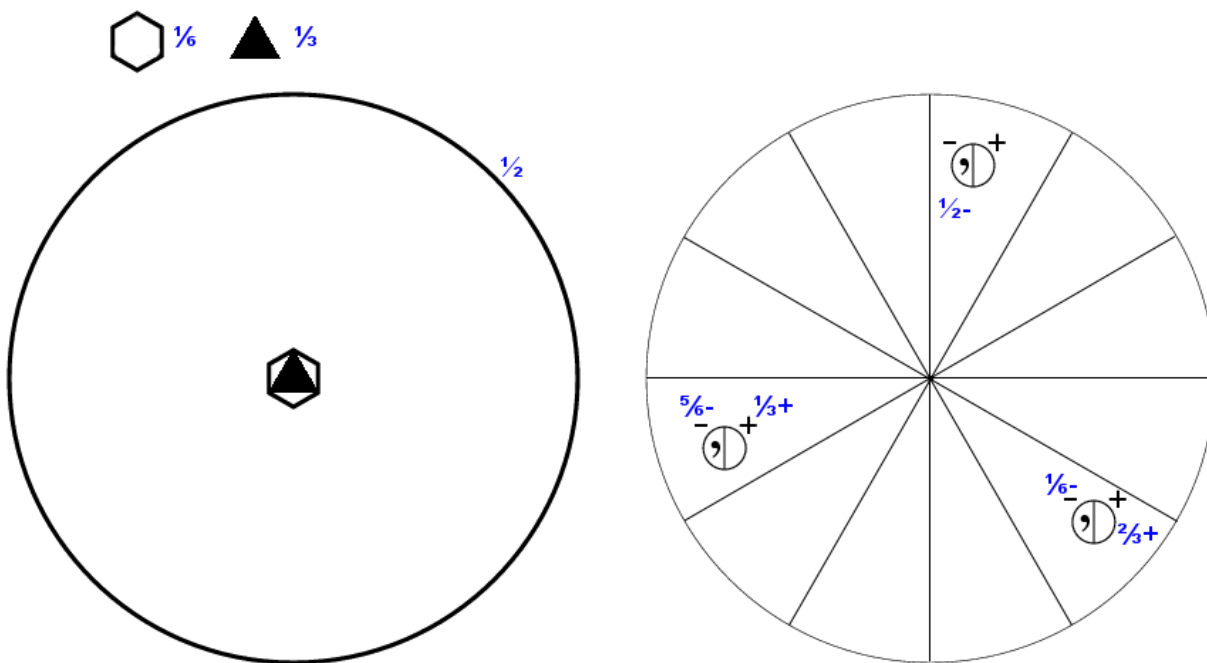

22.4.1.242

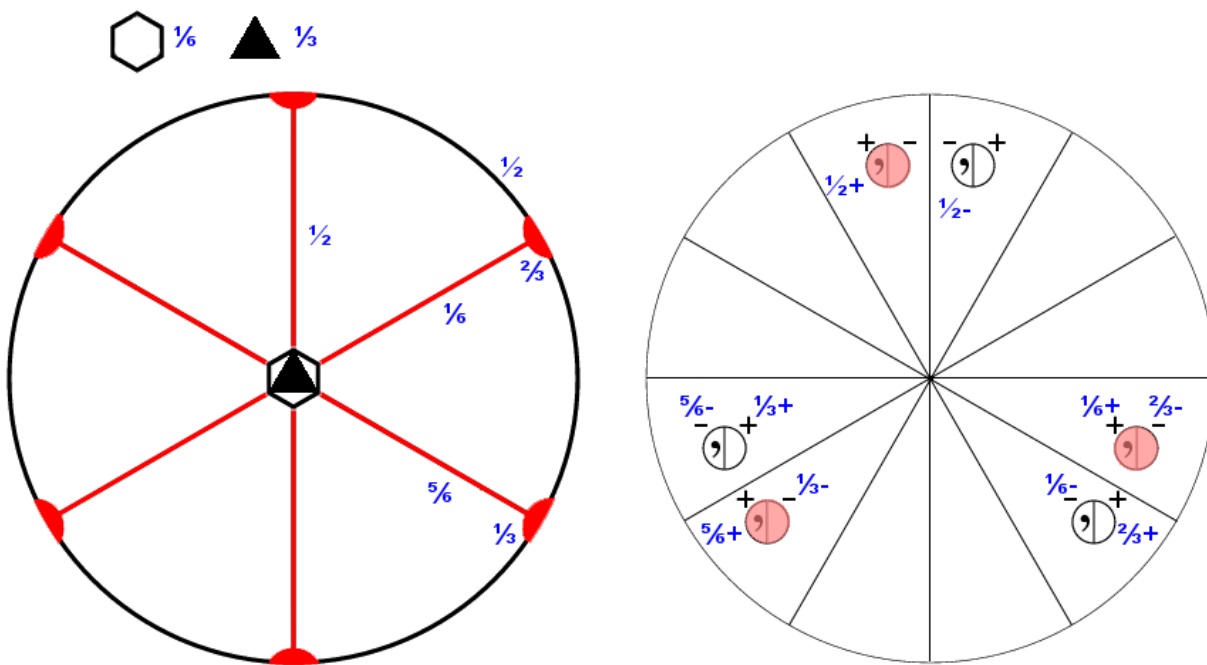

22.4.2.243

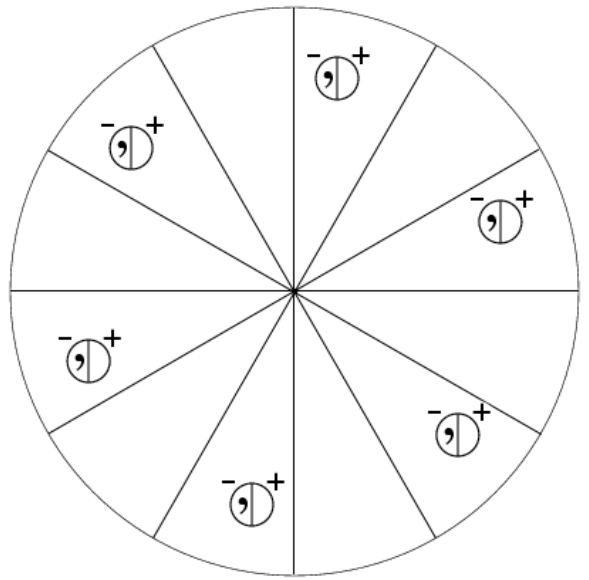
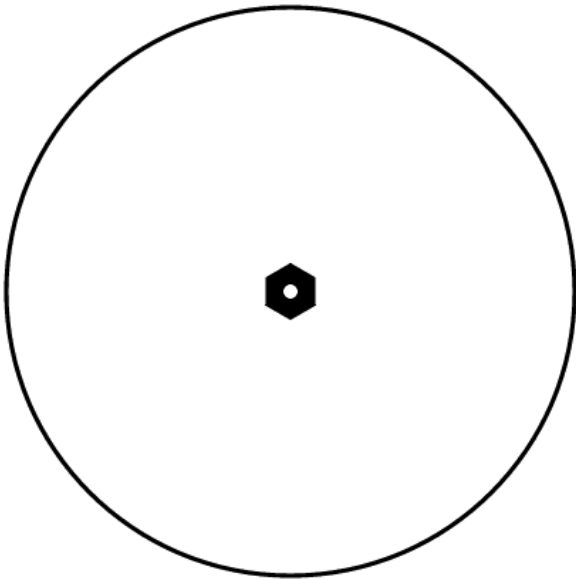

23.1.1.244

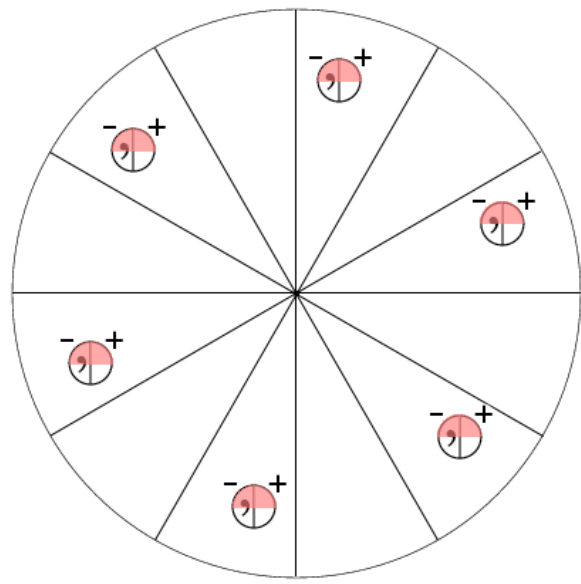
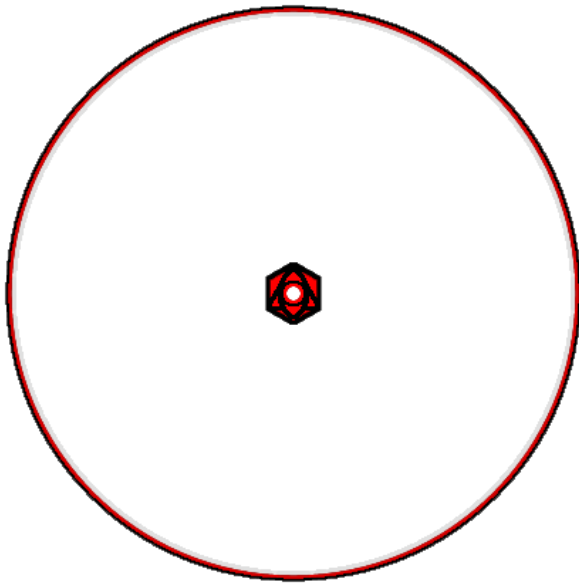

23.1.2.245

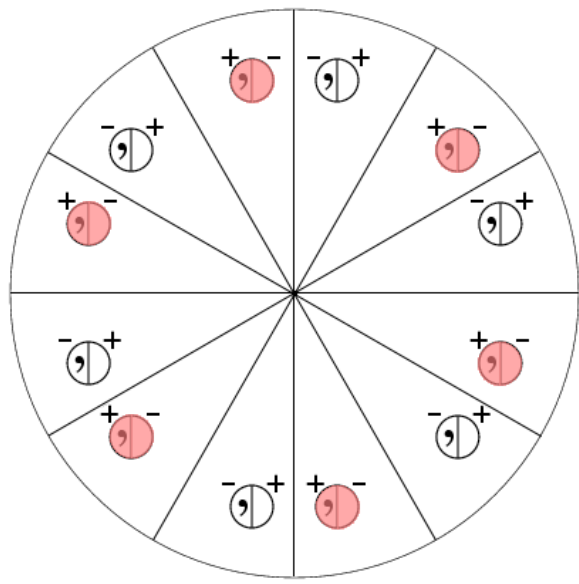
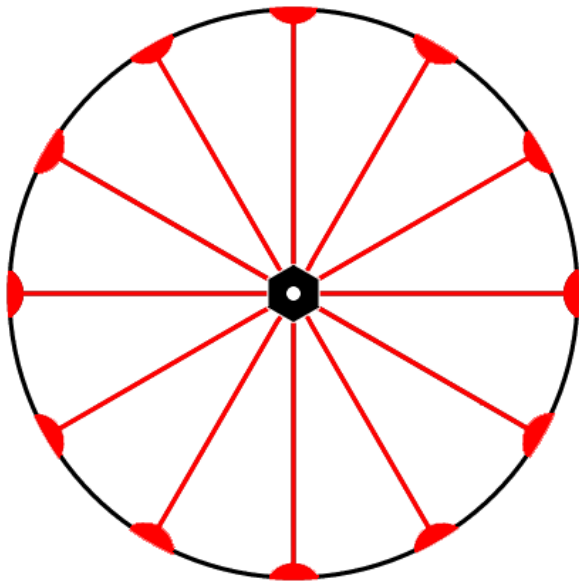

23.1.3.246

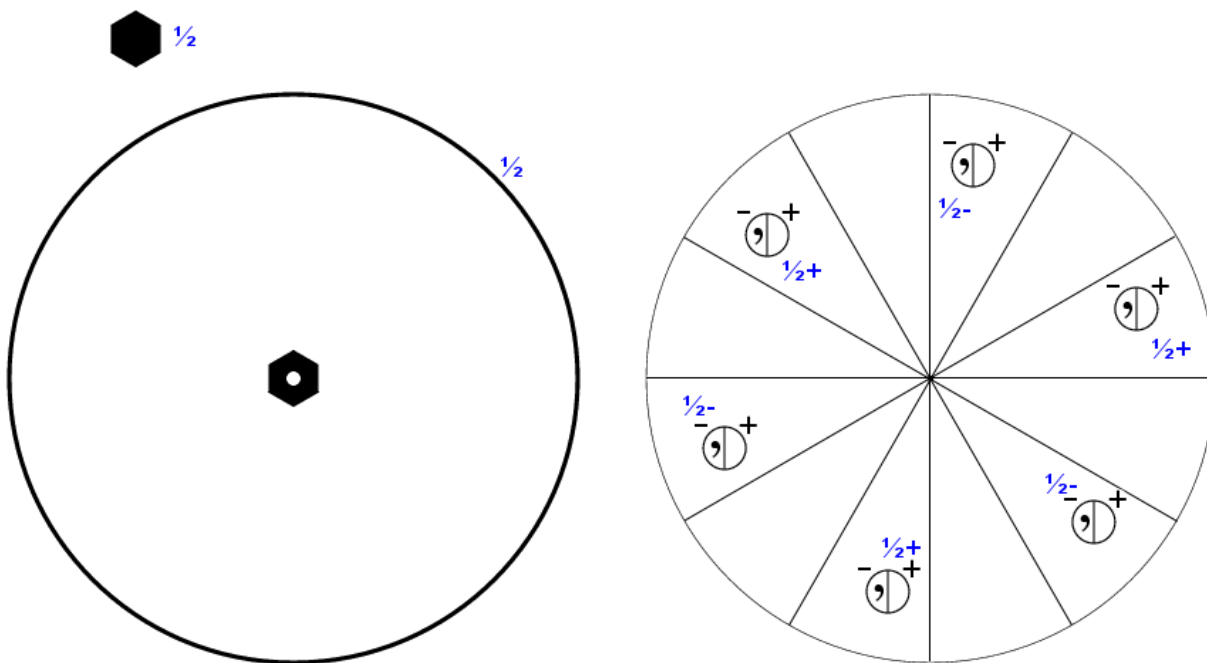

23.2.1.247

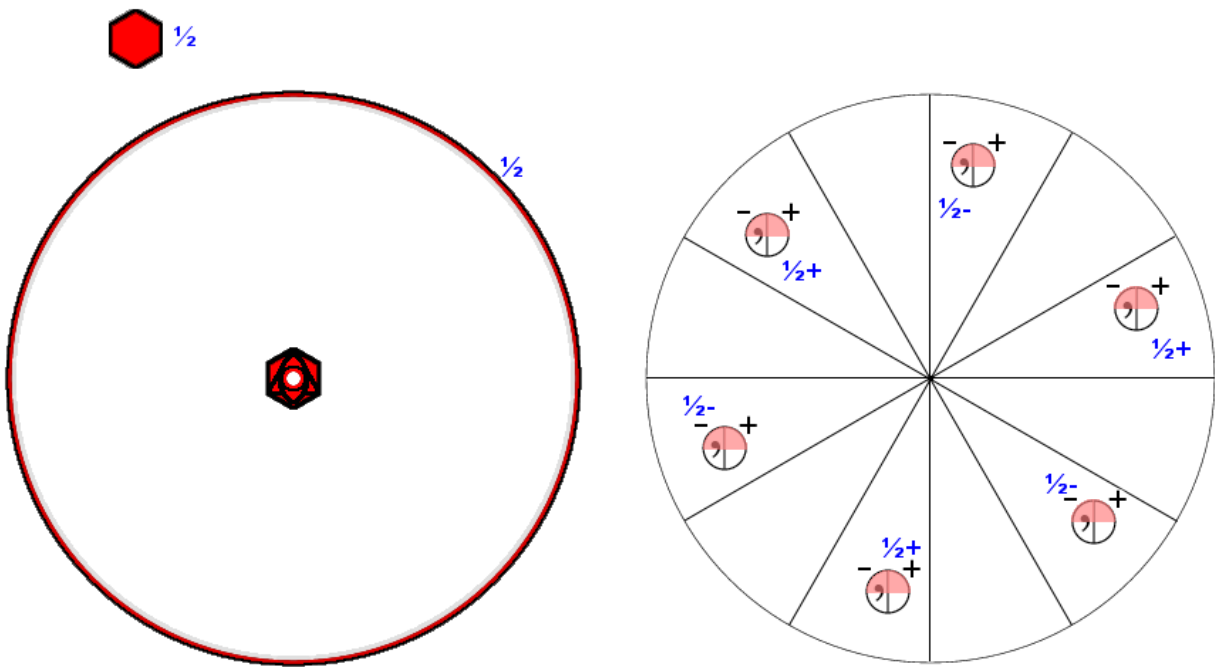

23.2.2.248

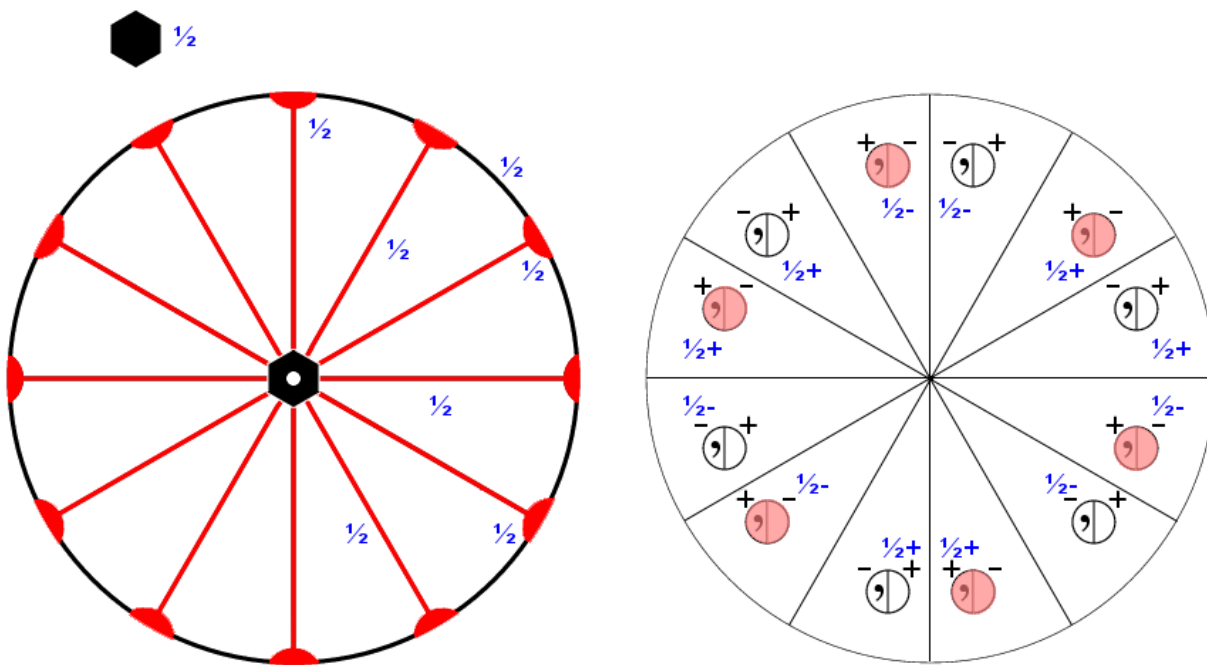

23.2.3.249

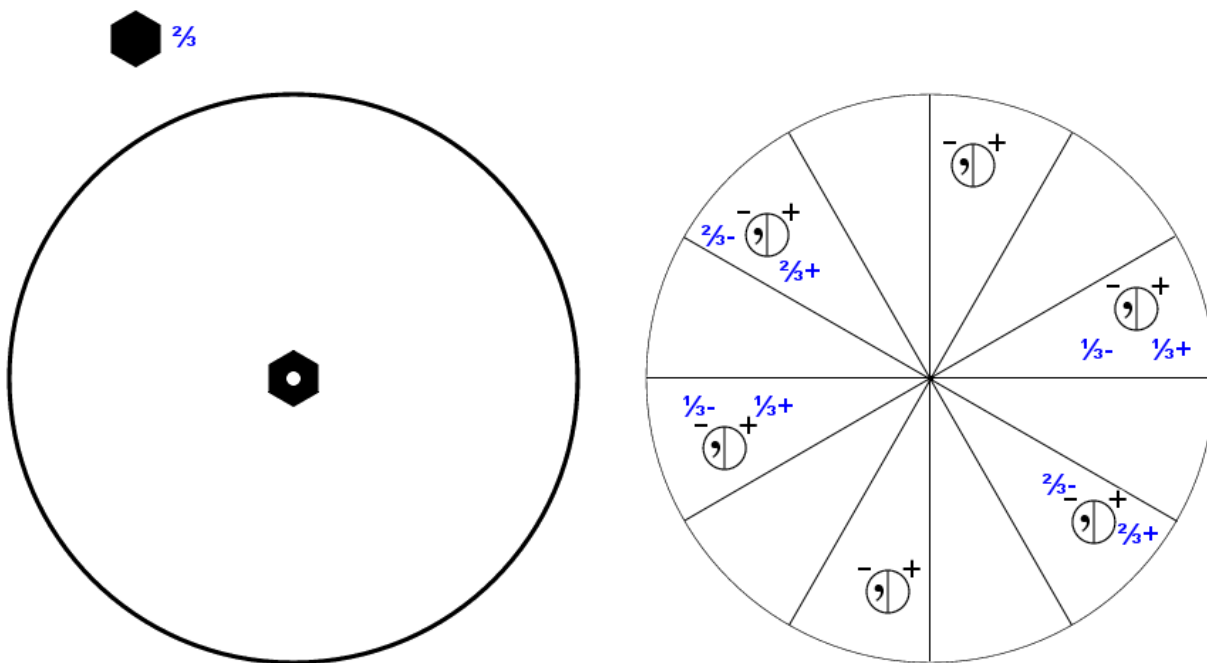

23.3.1.250

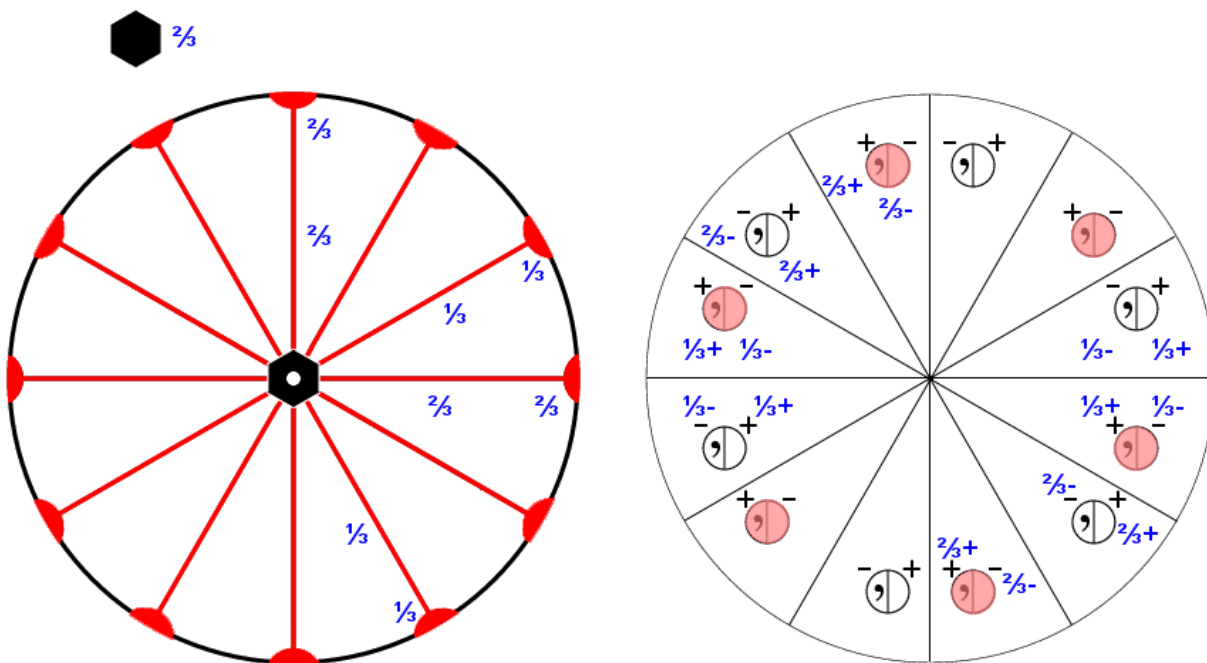

23.3.2.251

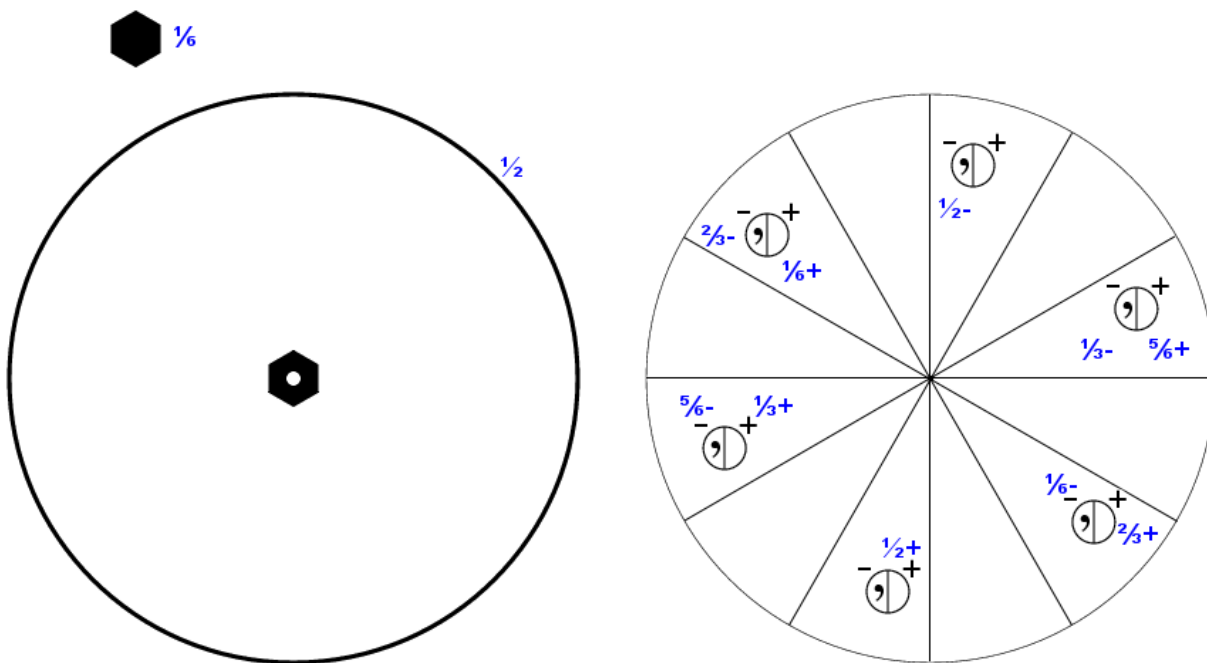

23.4.1.252

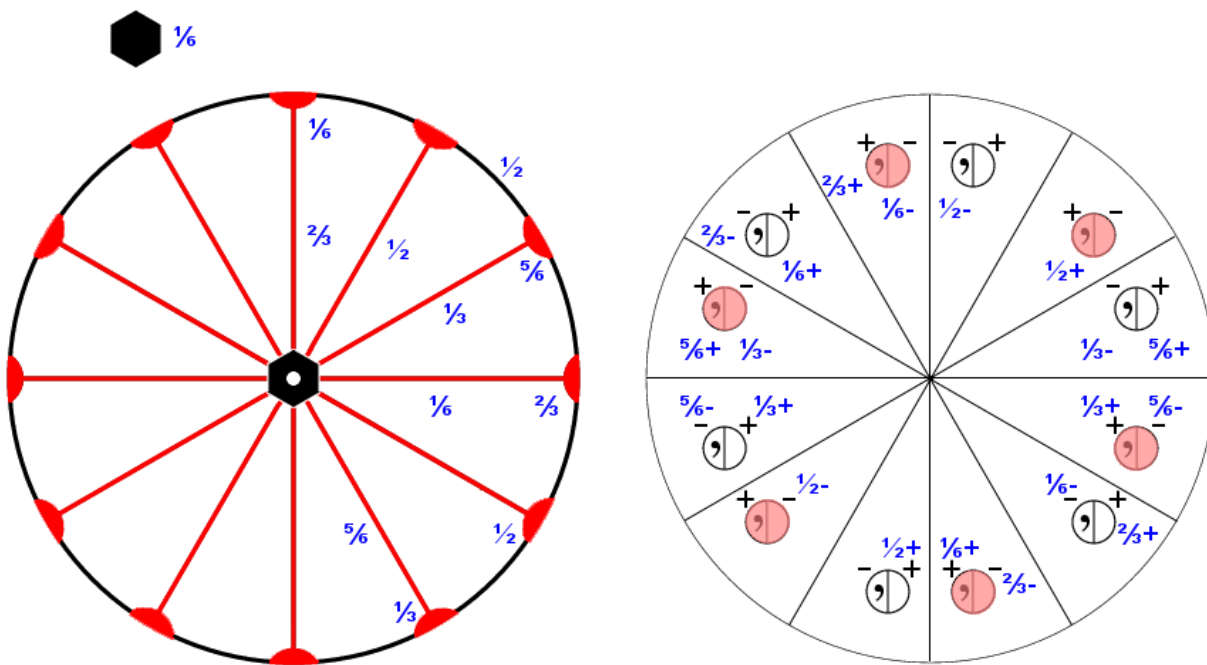

23.4.2.253

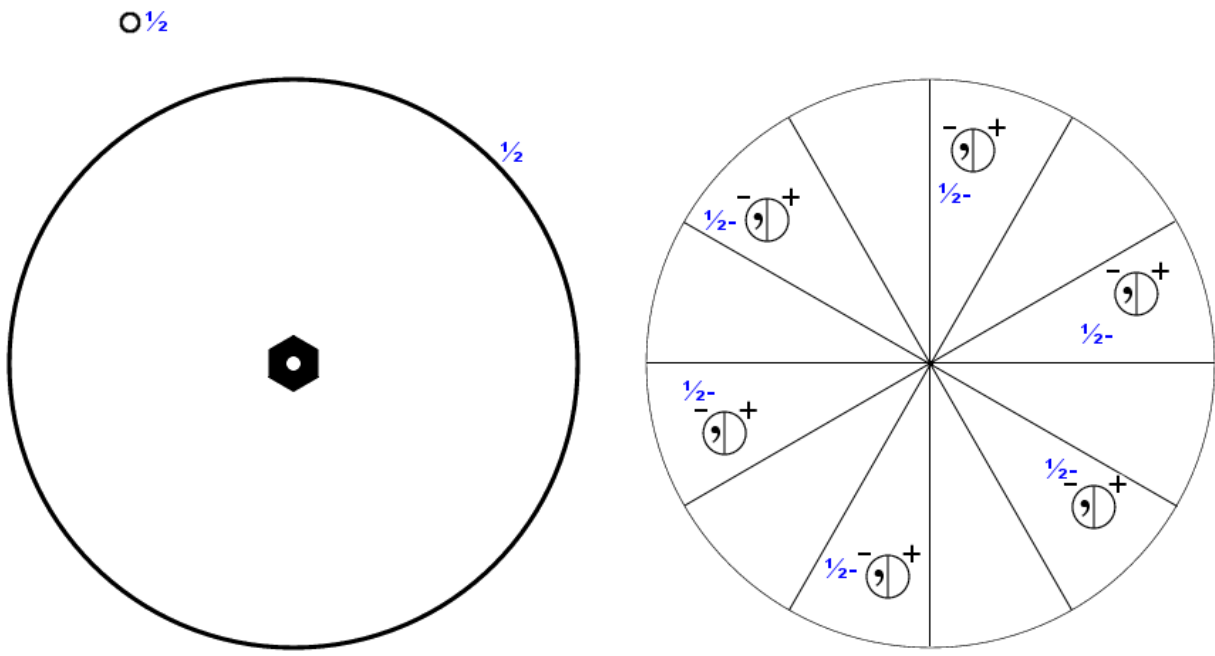

23.5.1.254

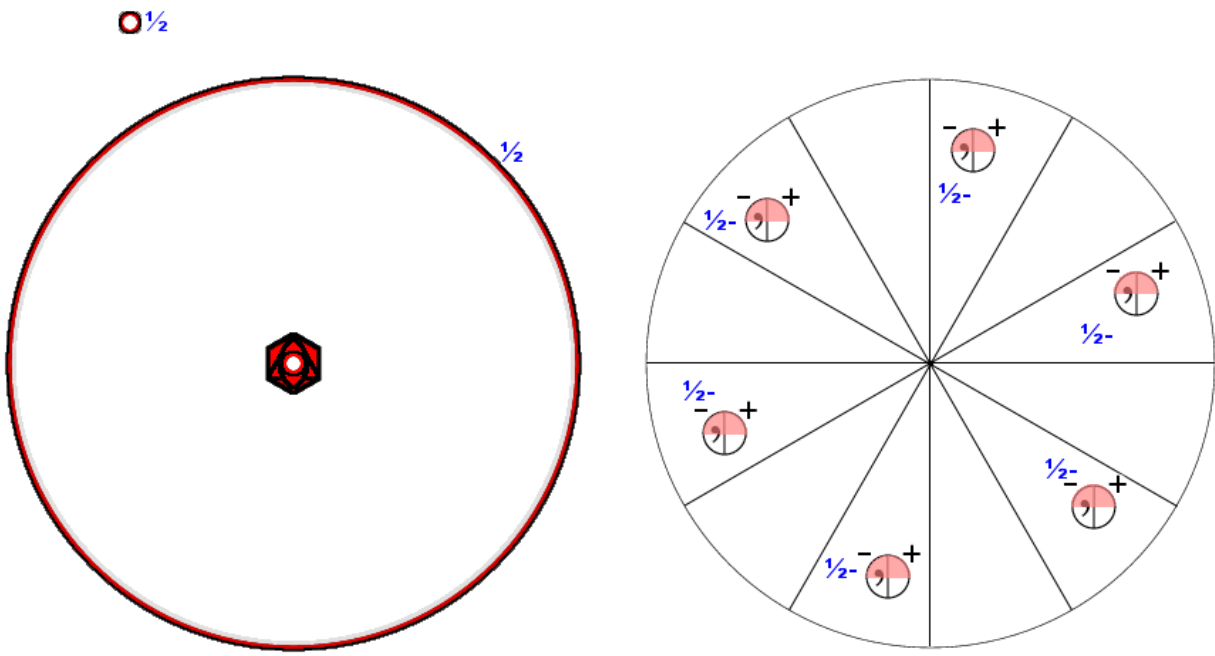

23.5.2.255

$\circ \frac{1}{2}$

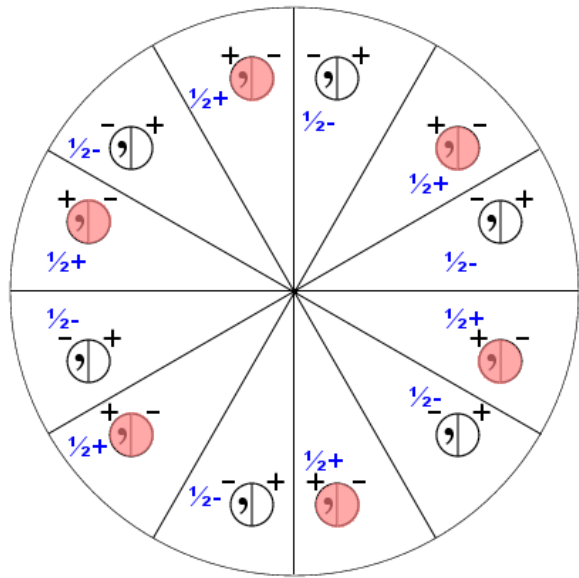
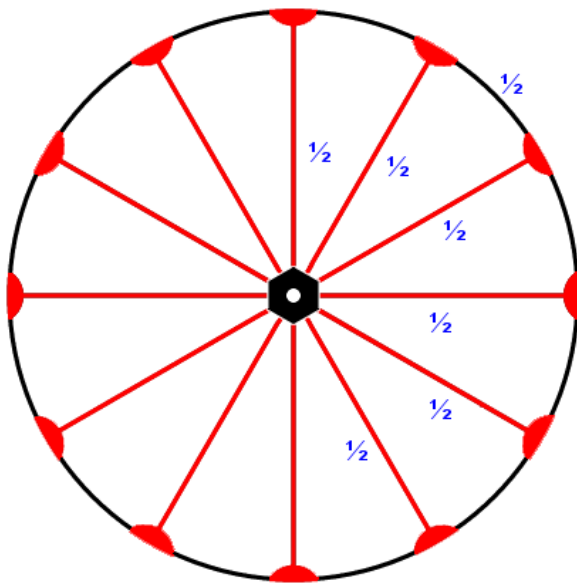

23.5.3.256

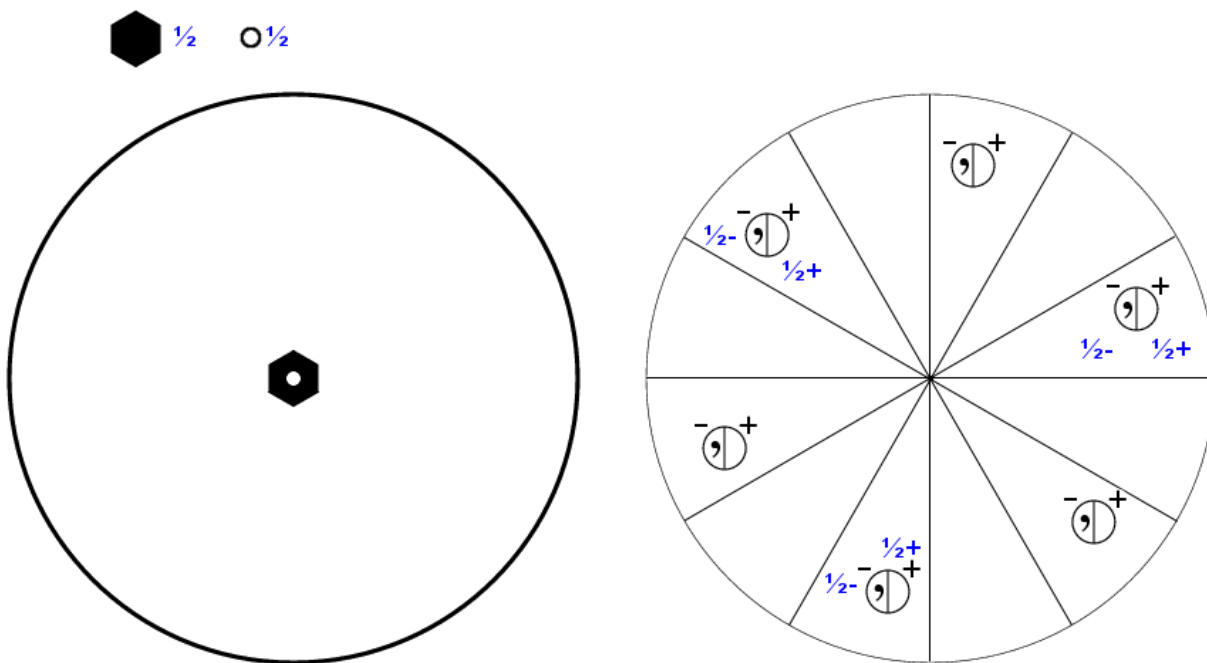

23.6.1.257

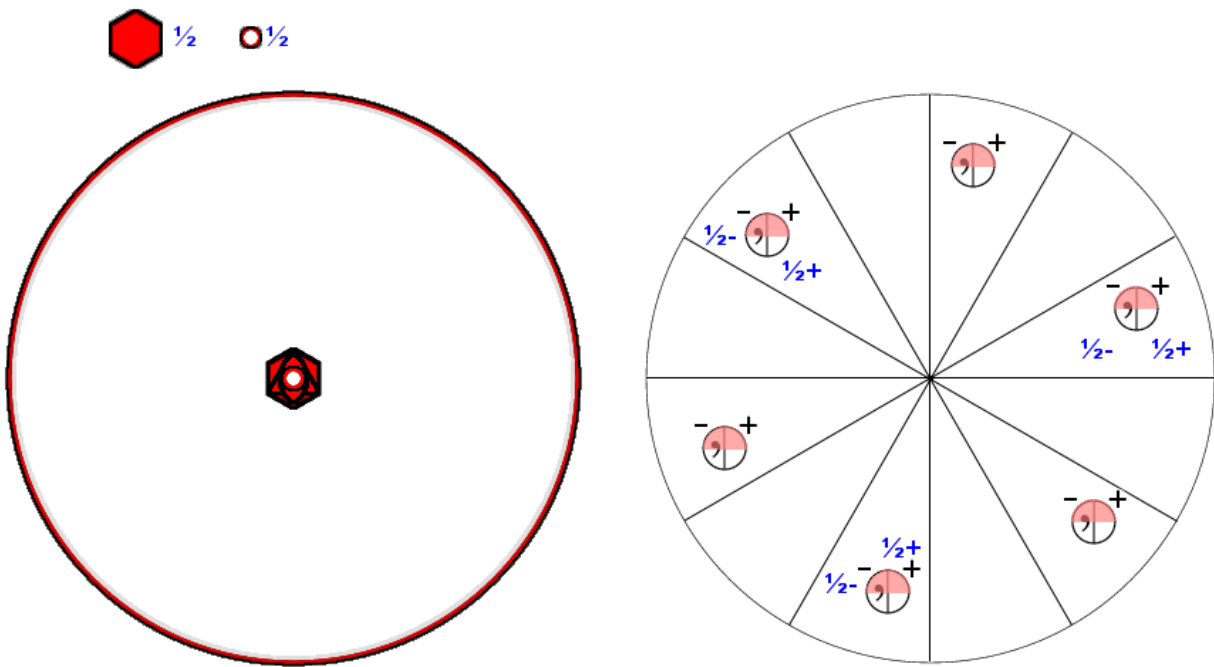

23.6.2.258

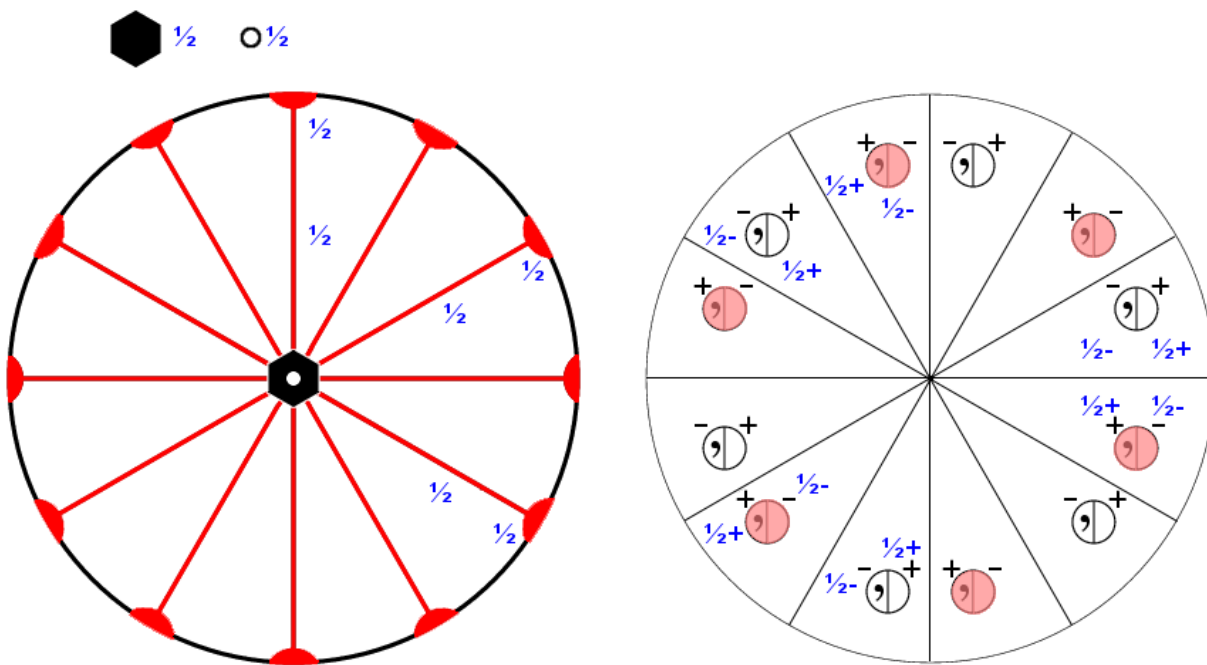

23.6.3.259

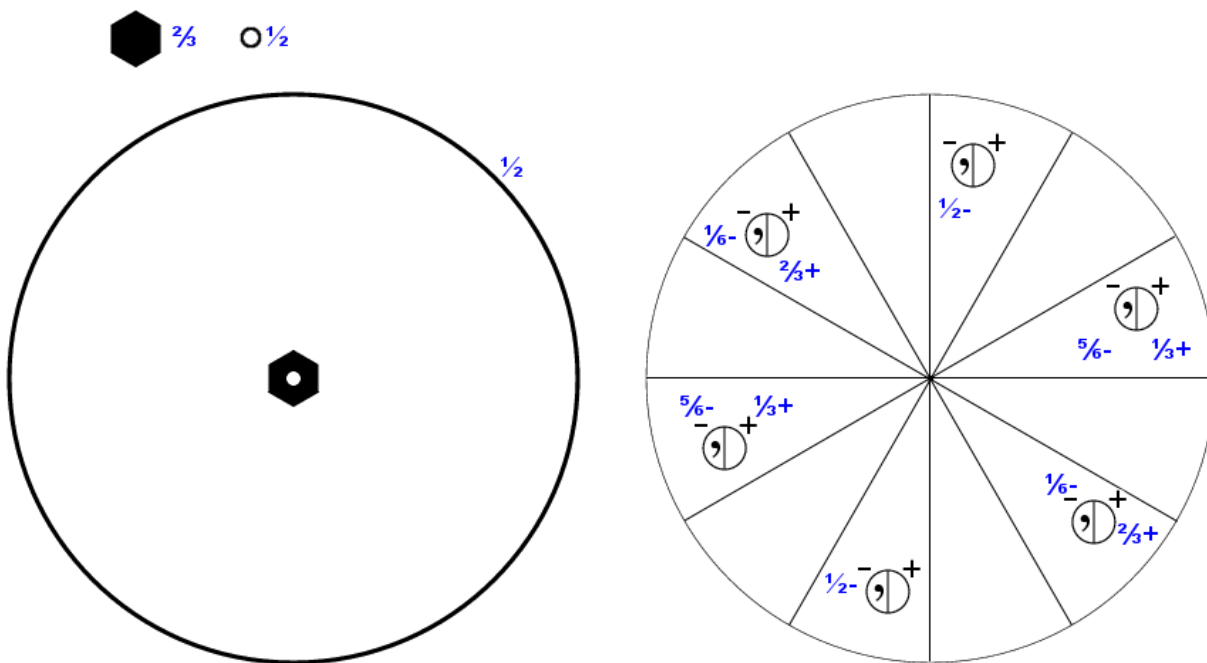

23.7.1.260

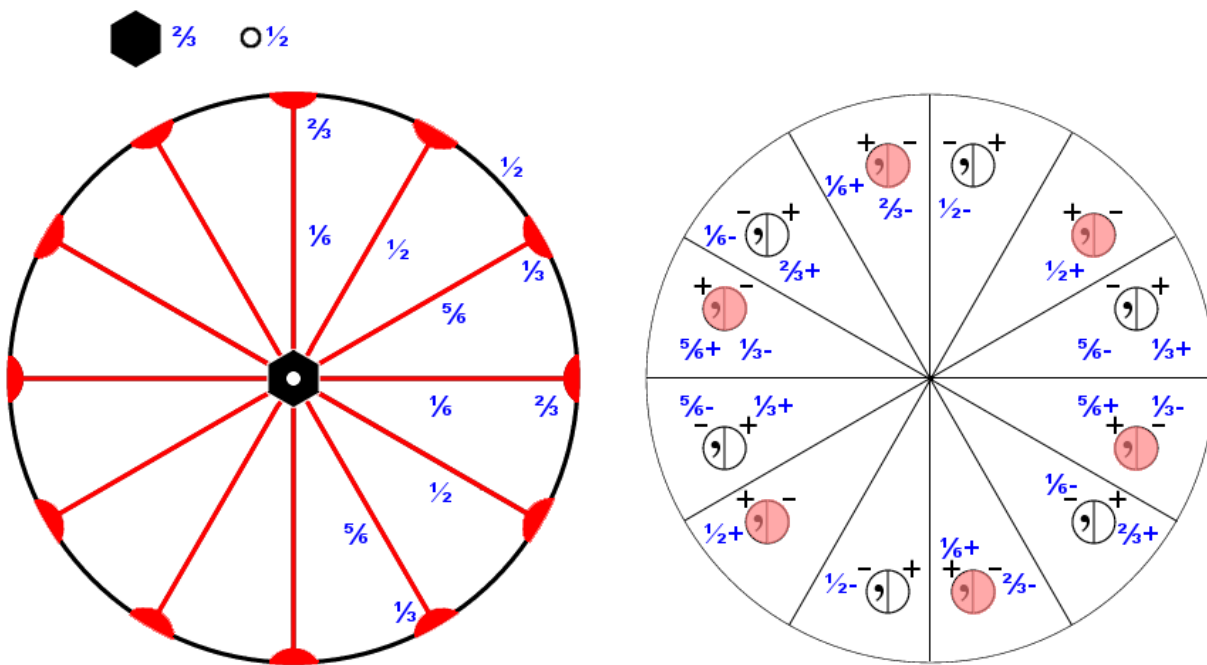

23.7.2.261

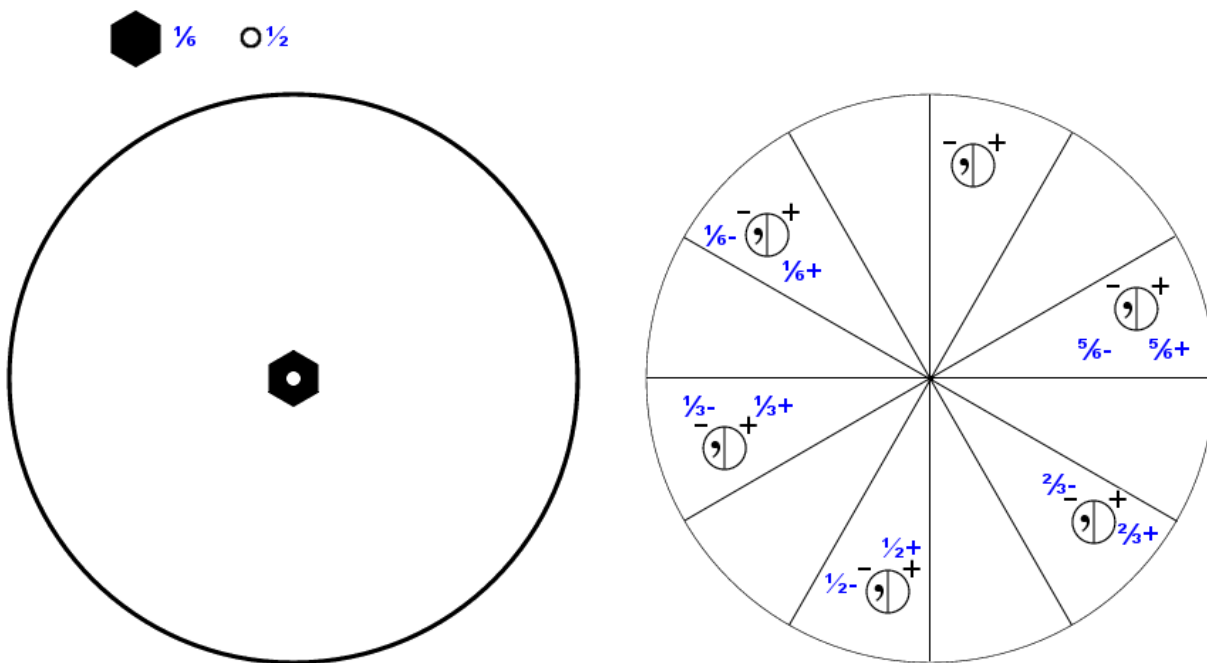

23.8.1.262

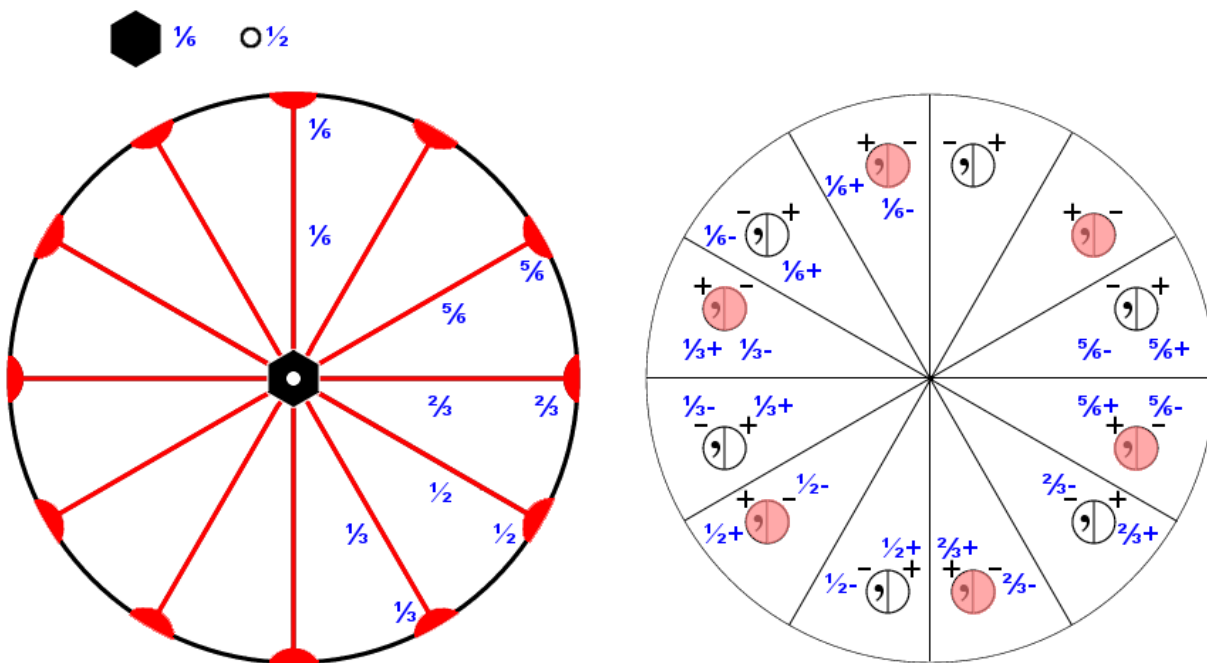

23.8.2.263

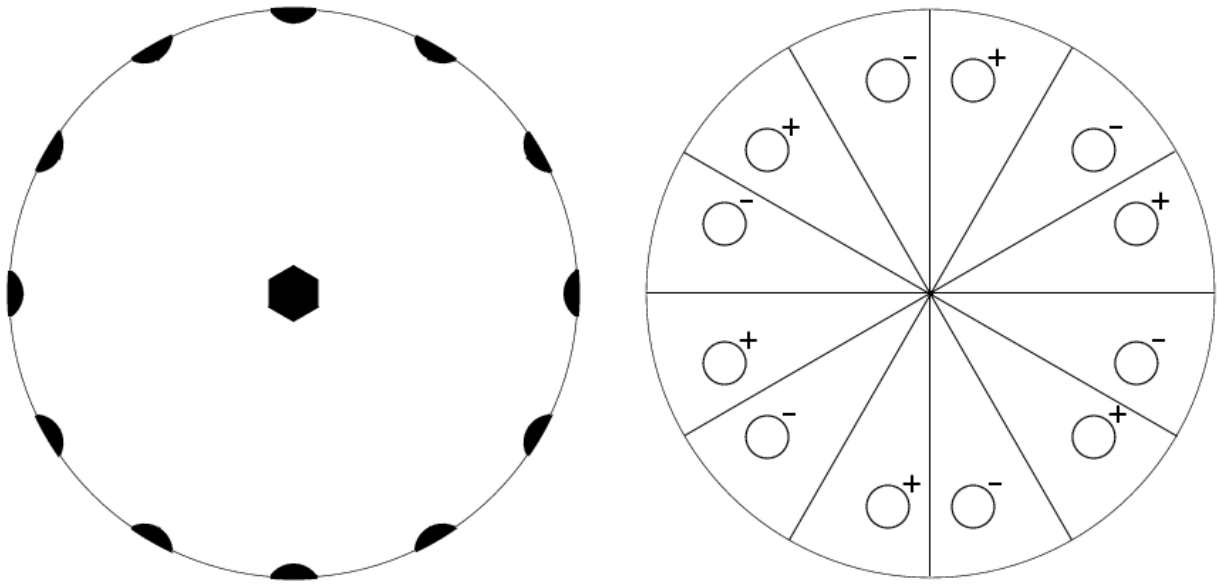

24.1.1.264

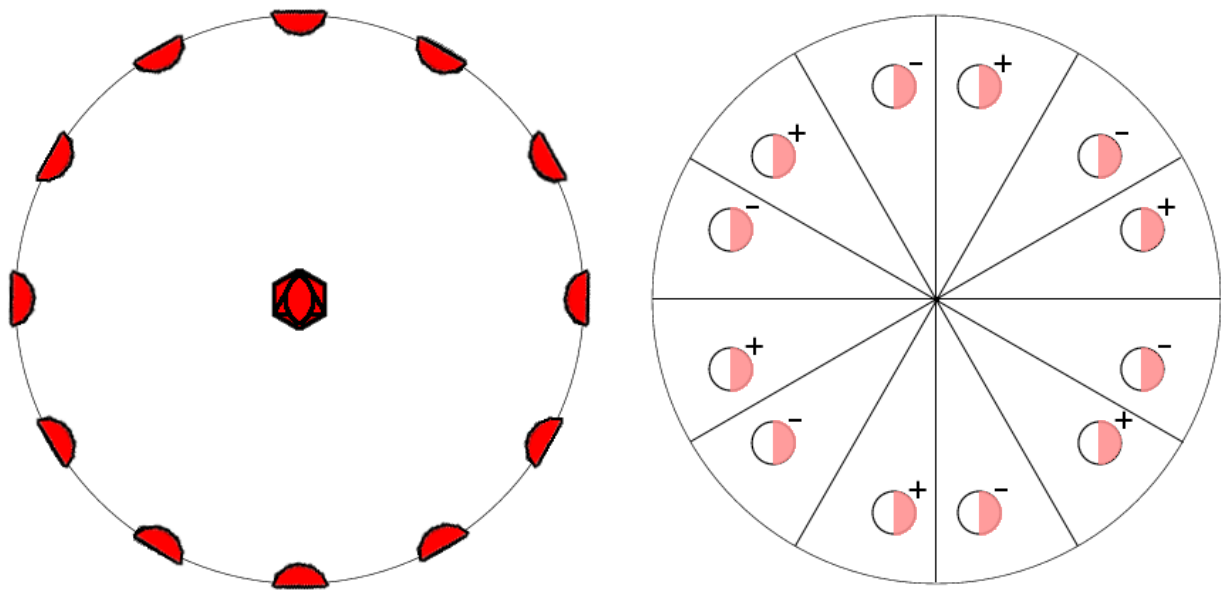

24.1.2.265

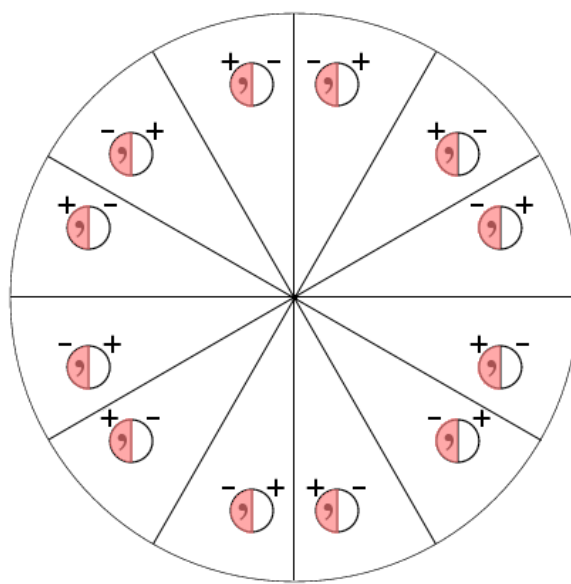
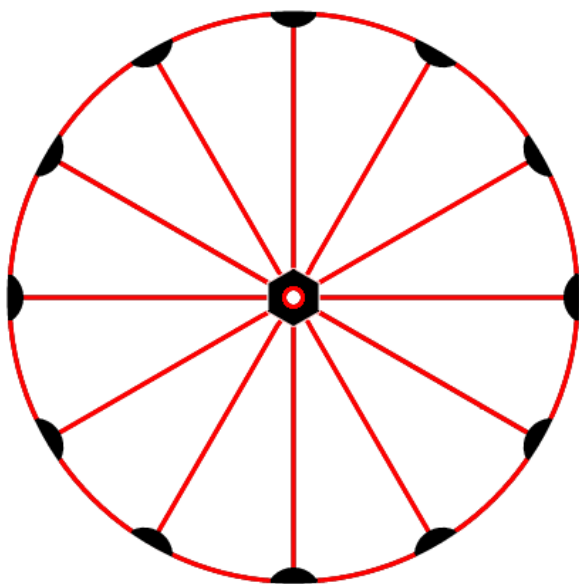

24.1.3.266

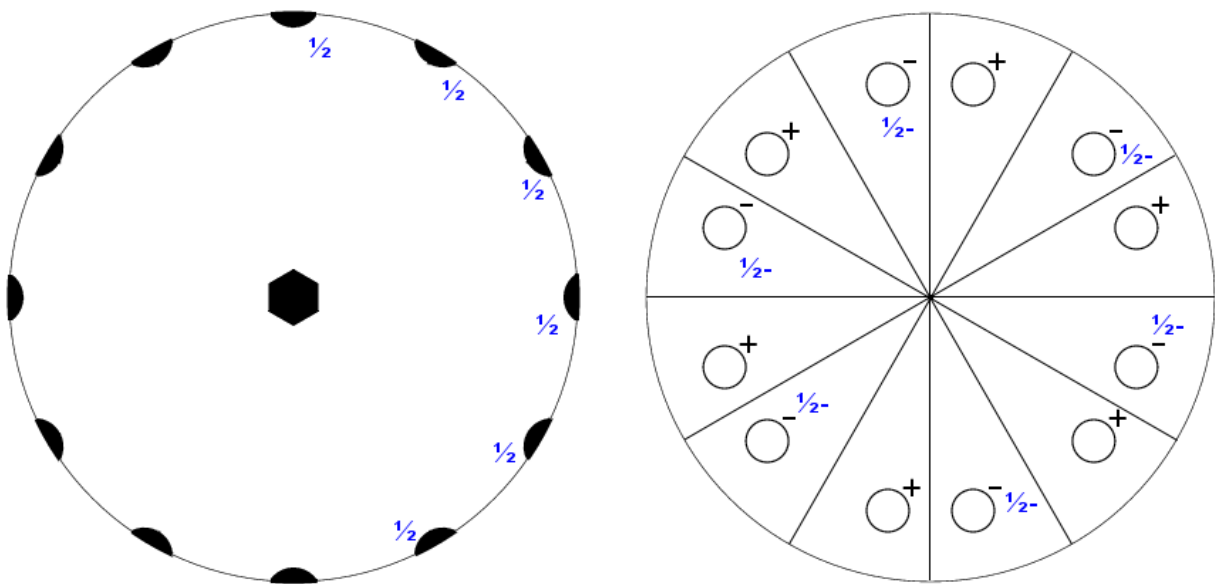

24.2.1.267

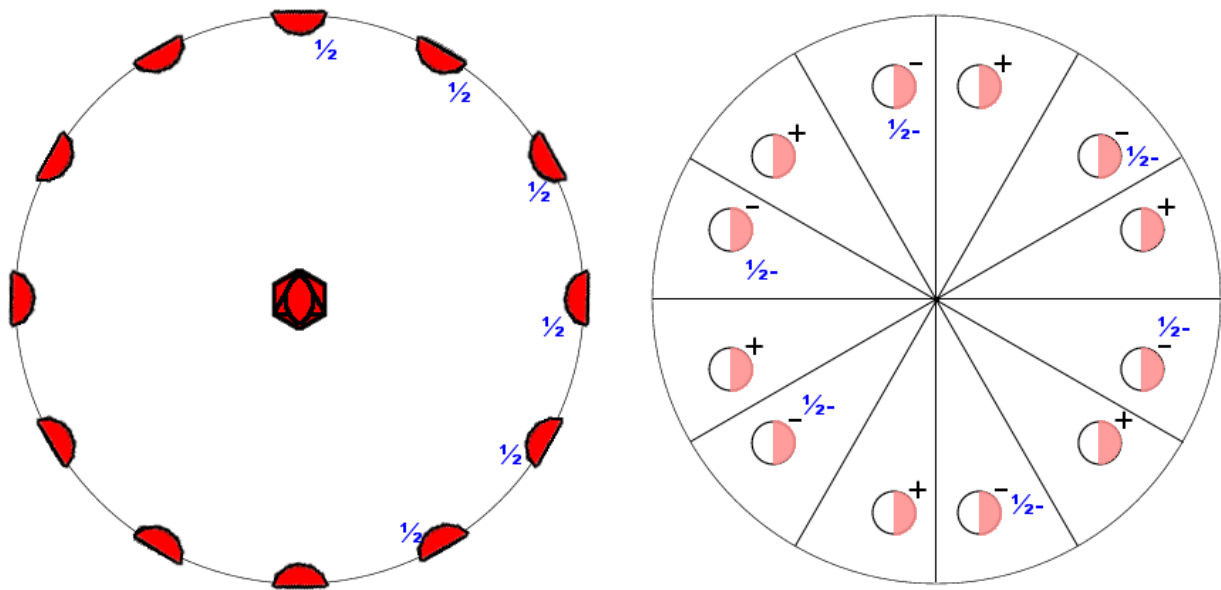

24.2.2.268

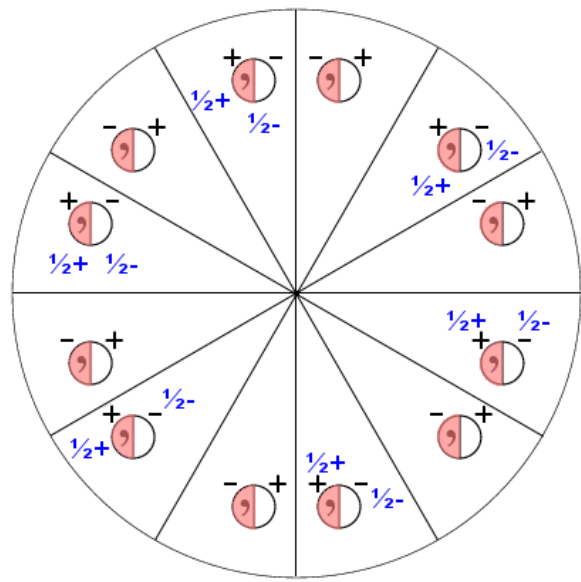
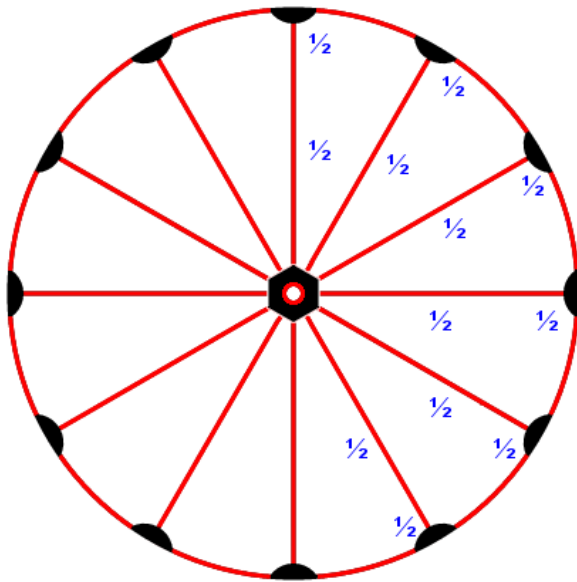

24.2.3.269

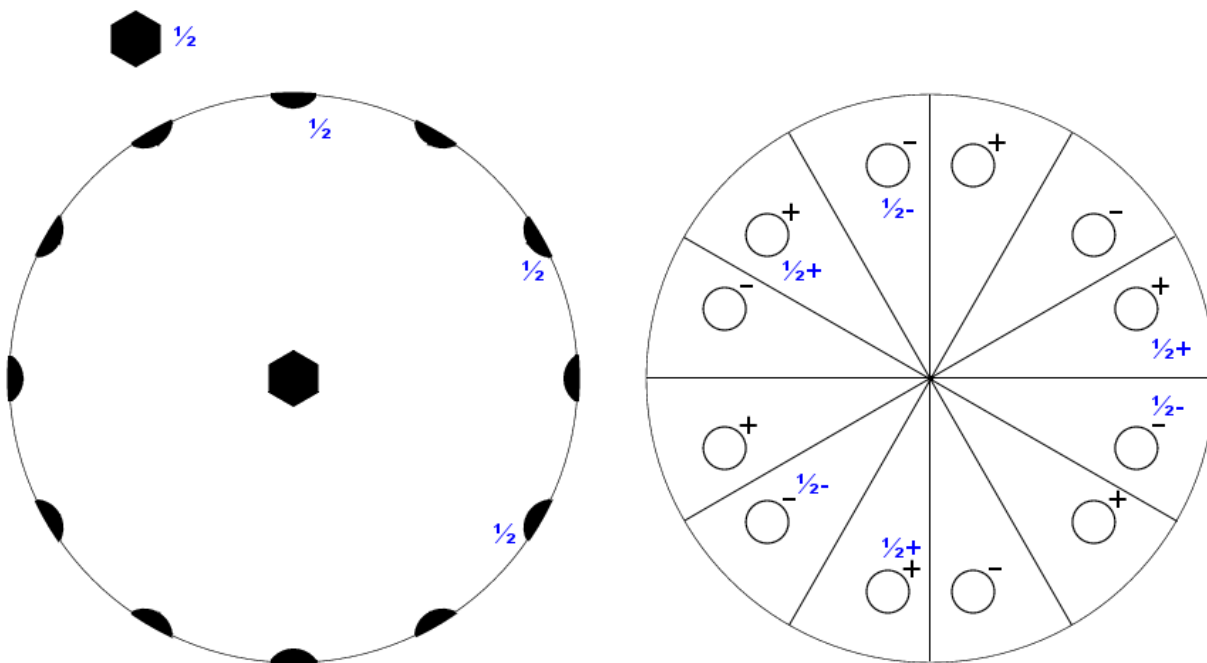

24.3.1.270

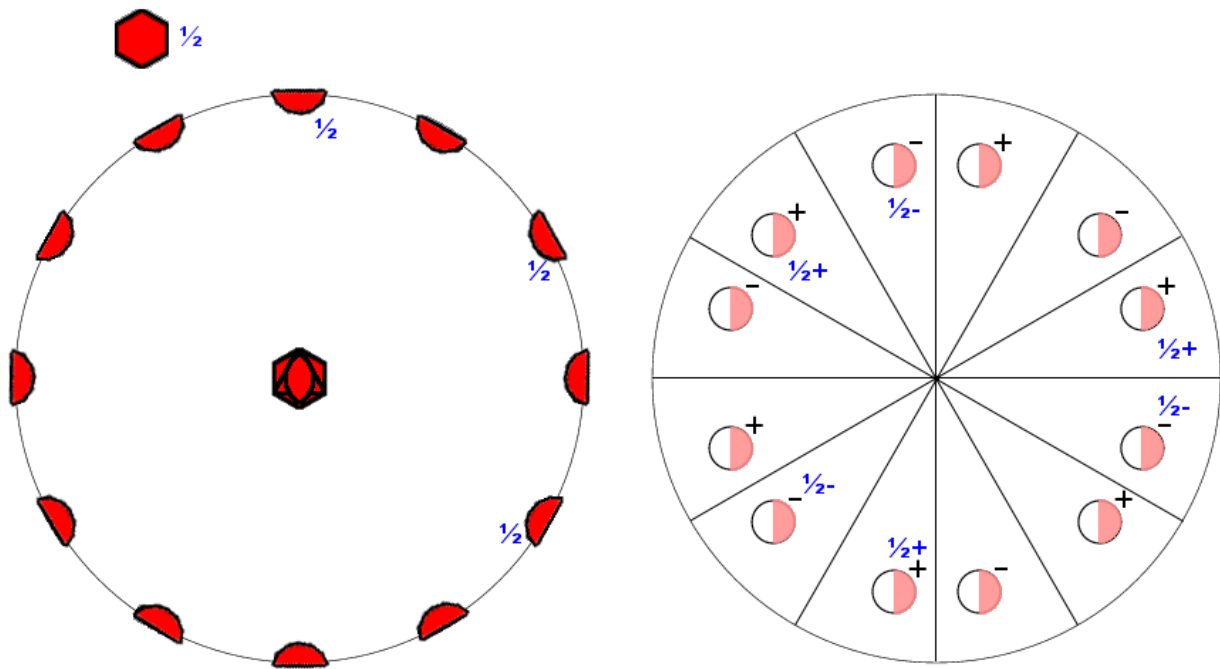

24.3.2.271

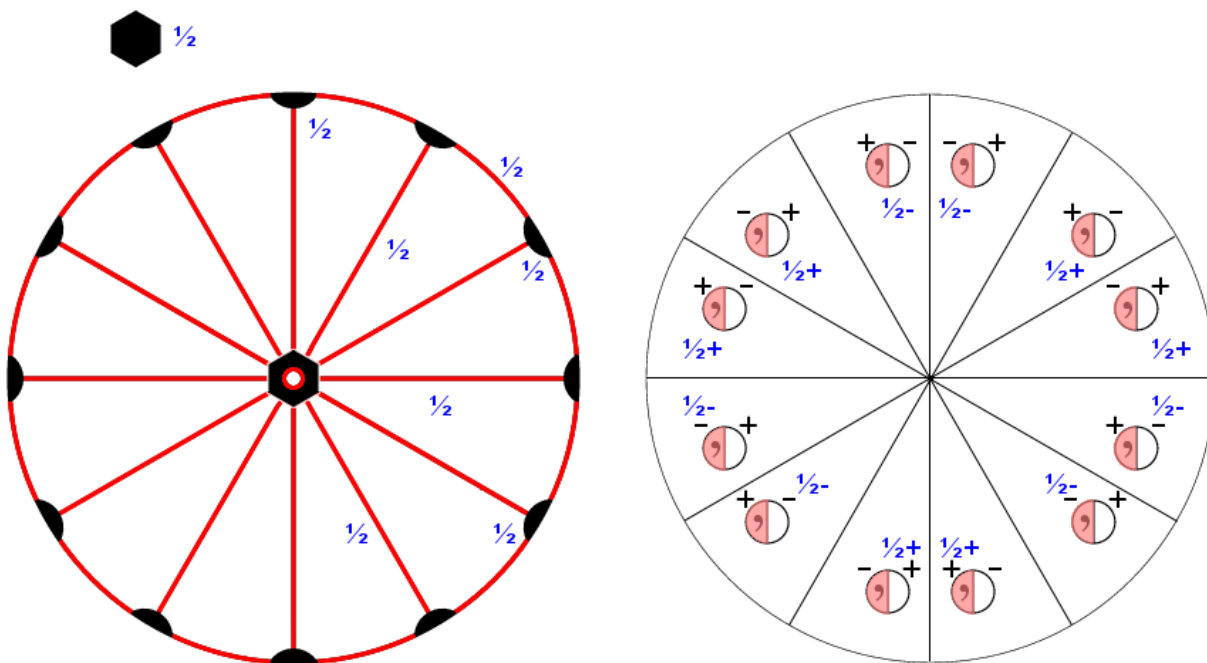

24.3.3.272

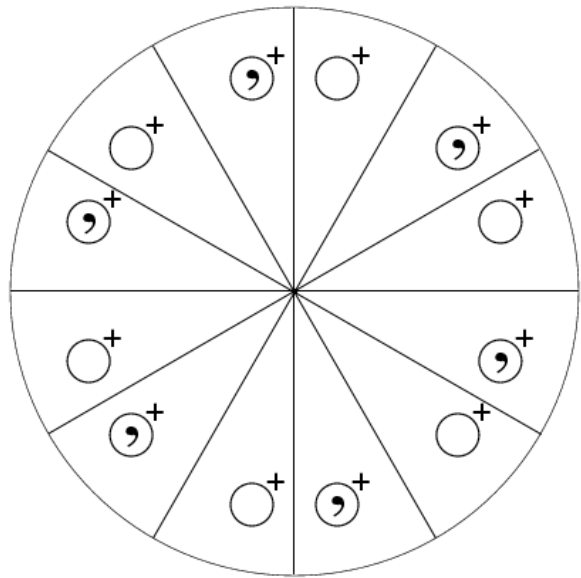
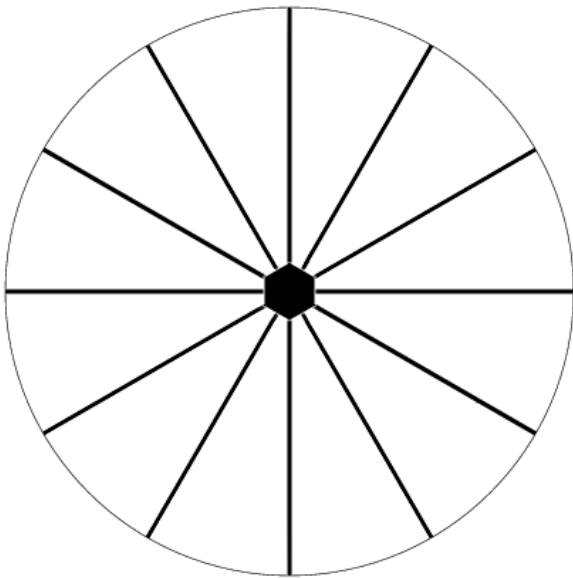

25.1.1.273

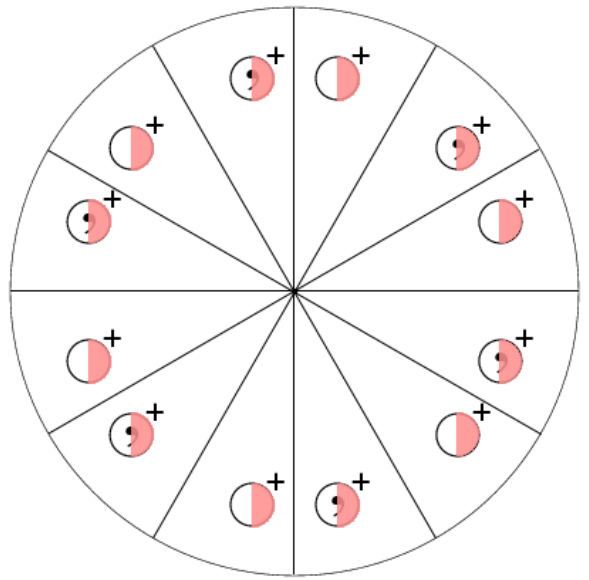
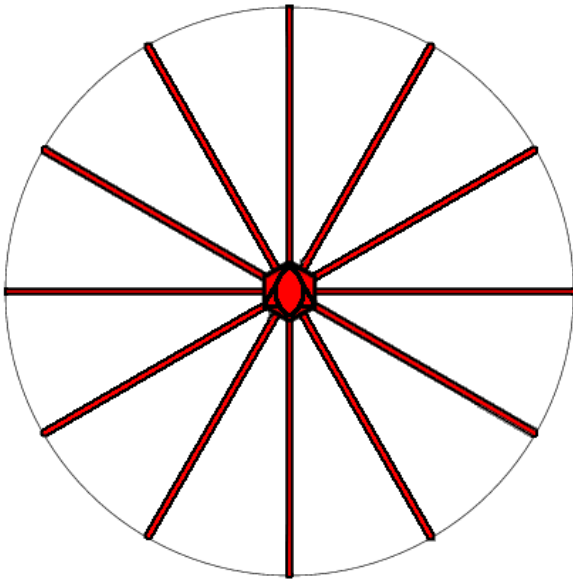

25.1.2.274

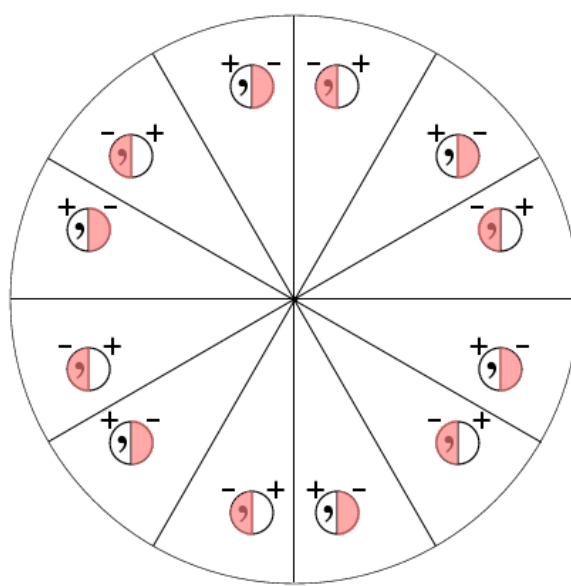
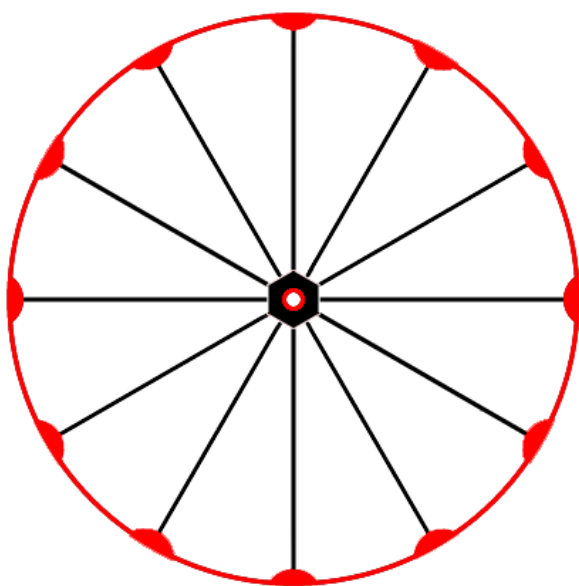

25.1.3.275

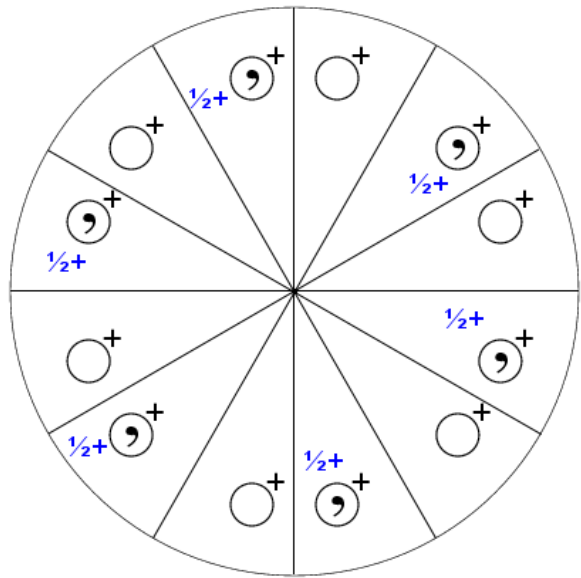
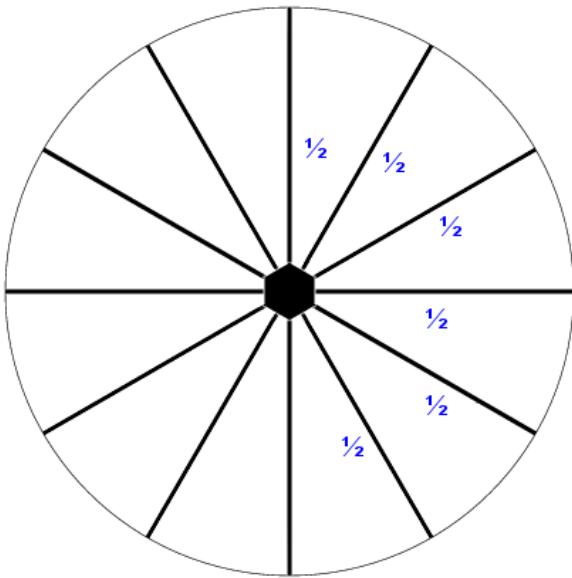

25.2.1.276

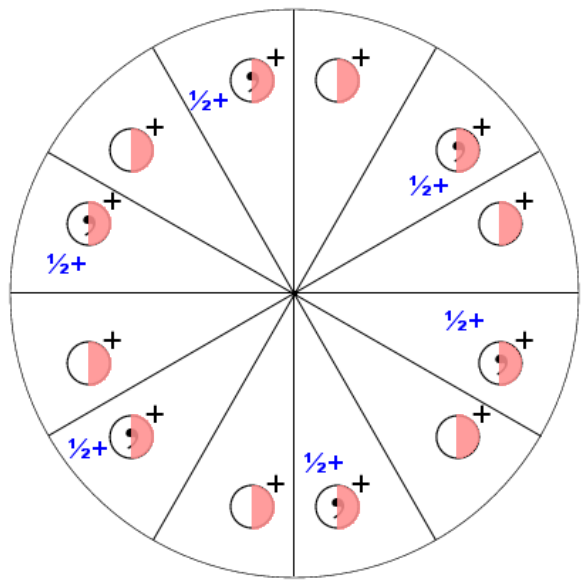
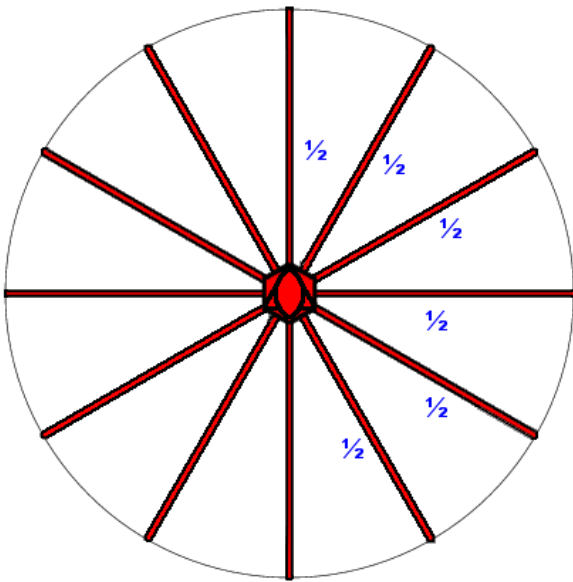

25.2.2.277

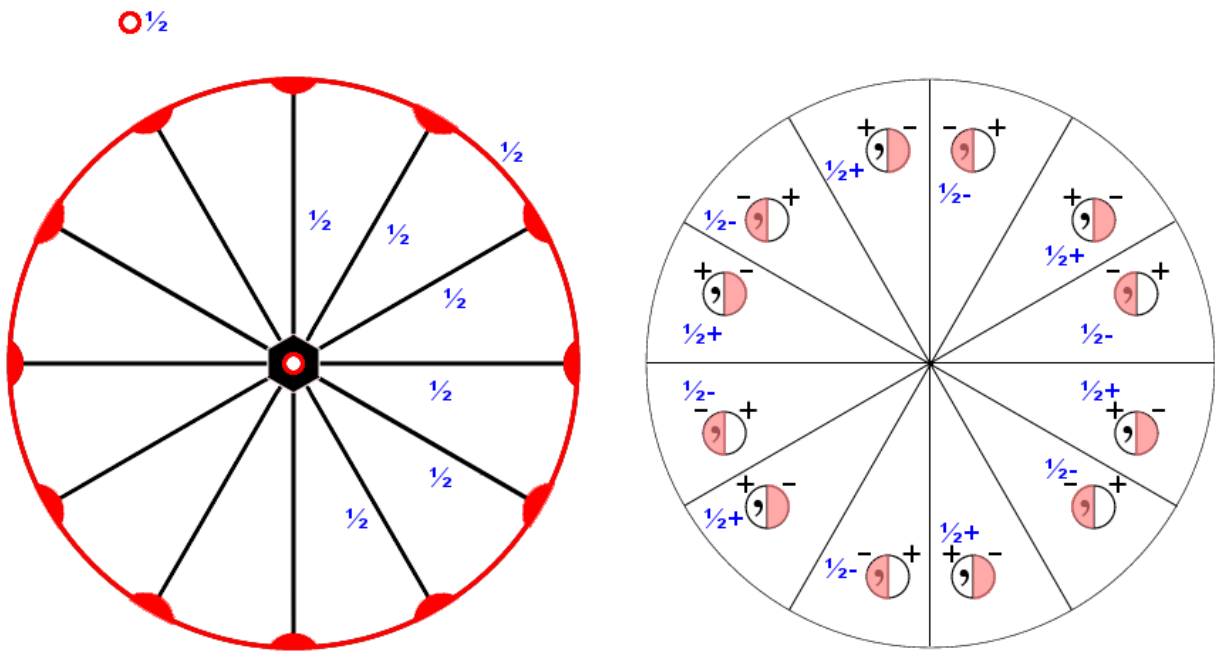

25.2.3.278

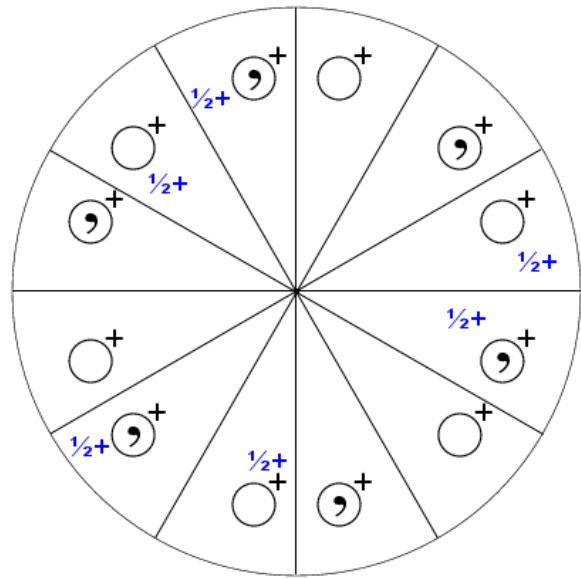
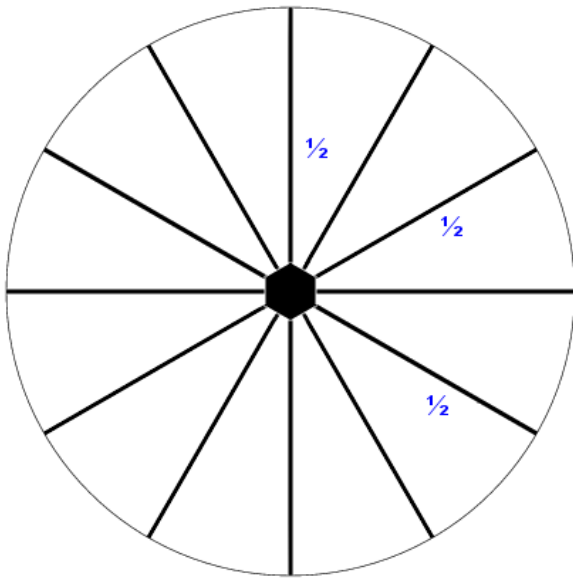

25.3.1.279

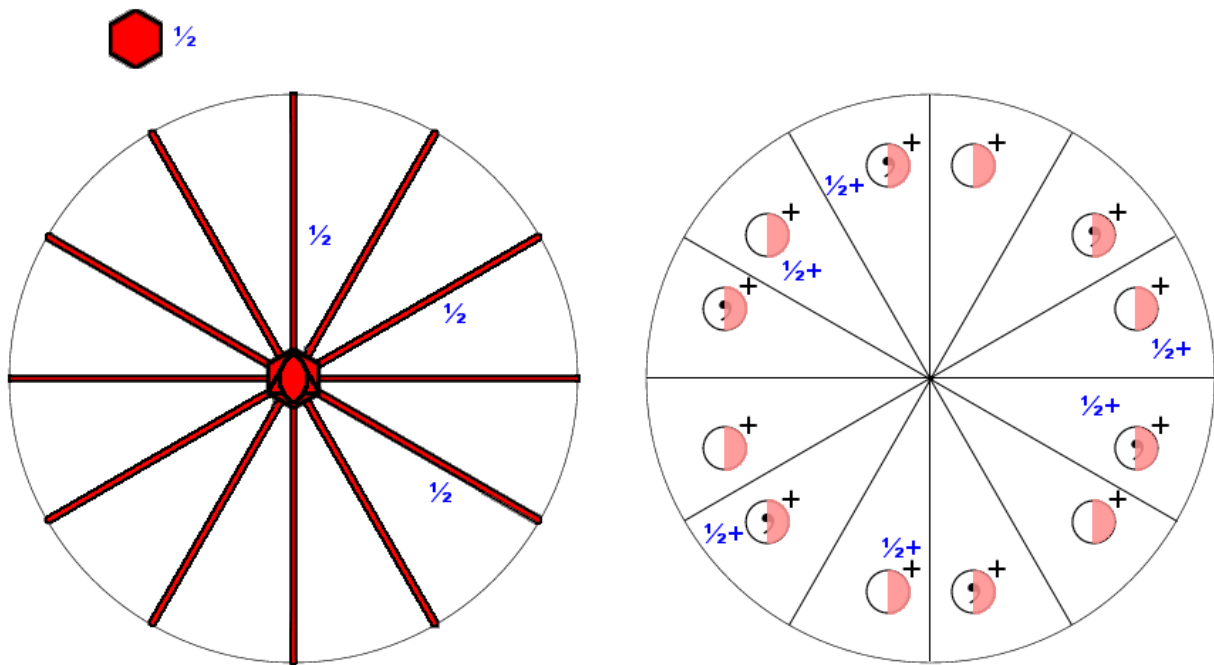

25.3.2.280

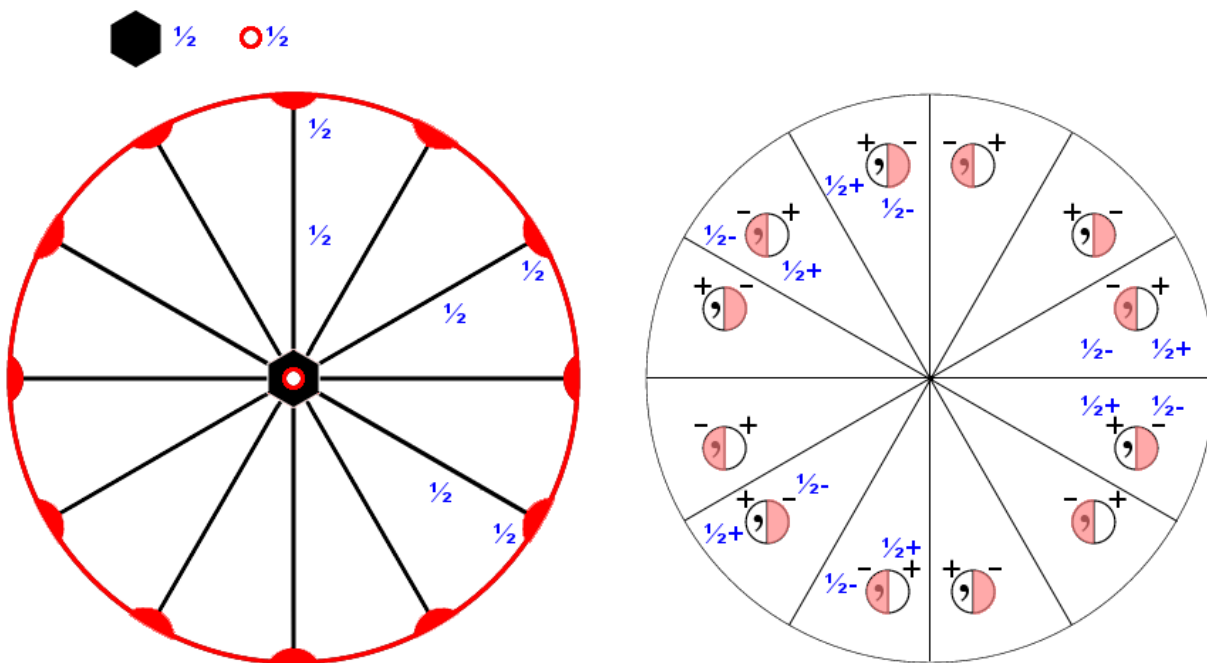

25.3.3.281

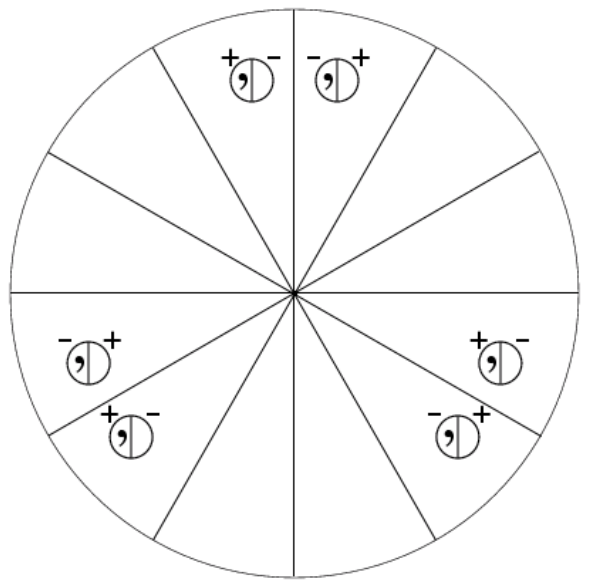
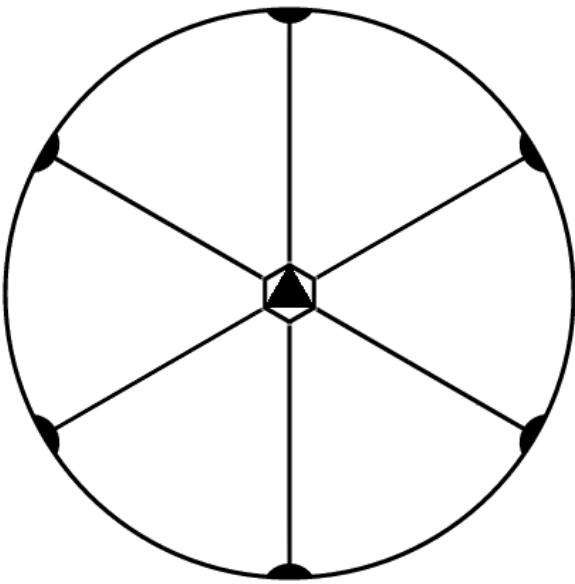

26.1.1.282

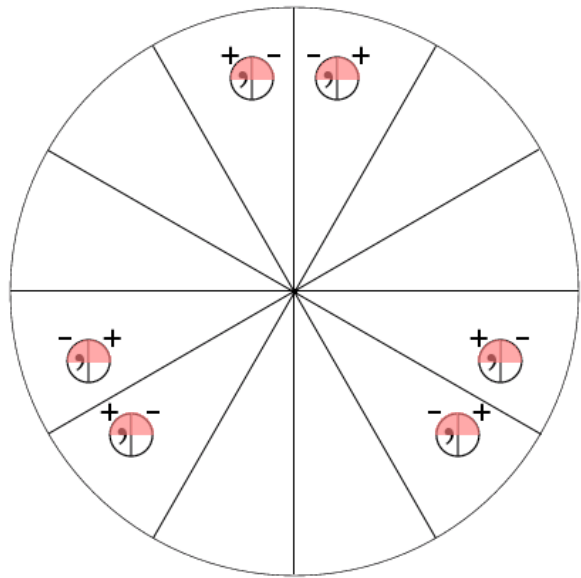
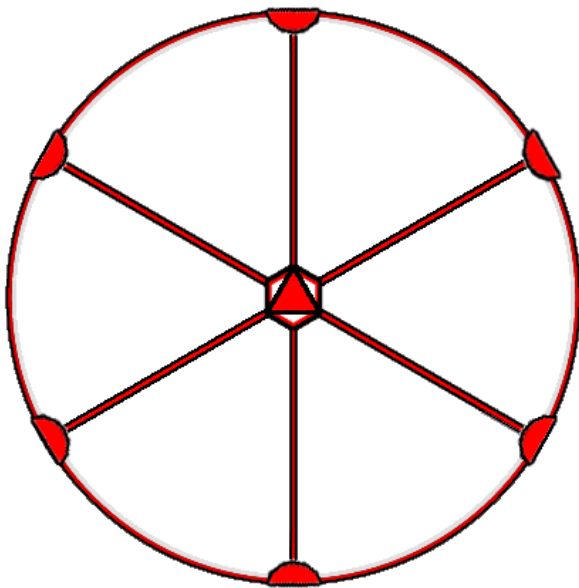

26.1.2.283

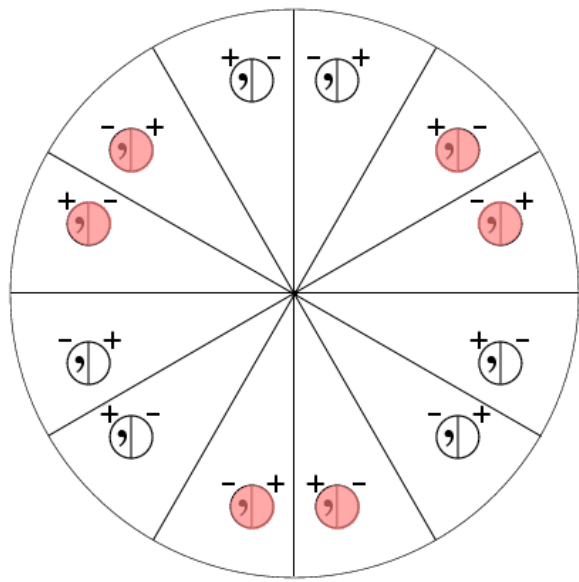
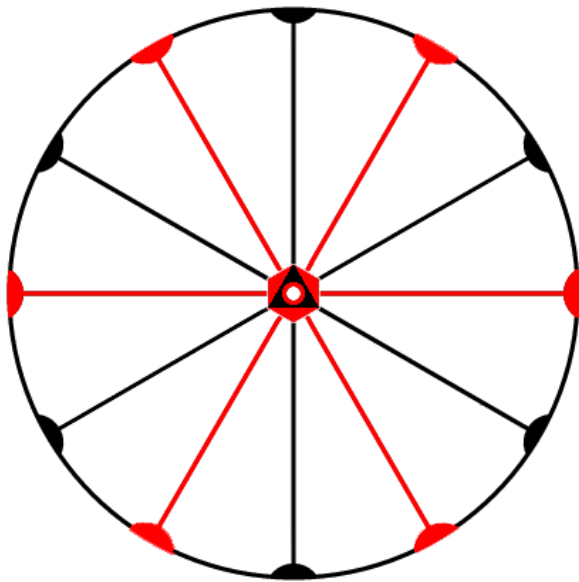

26.1.3.284

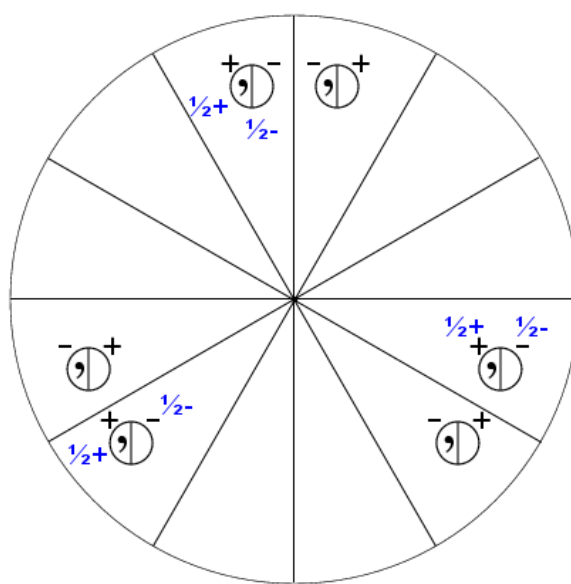
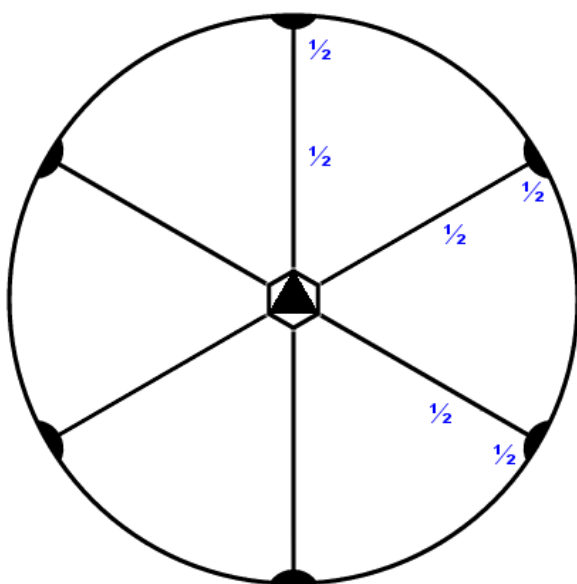

26.2.1.285

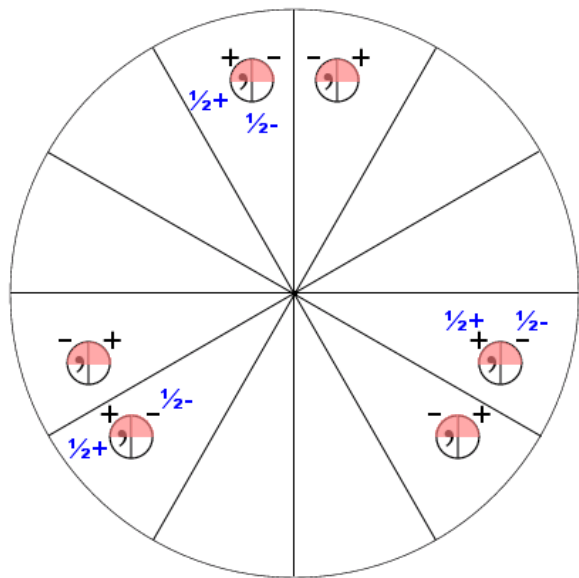
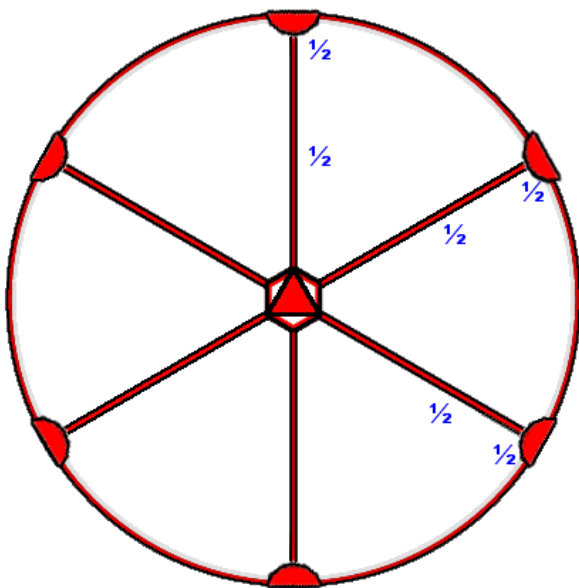

26.2.2.286

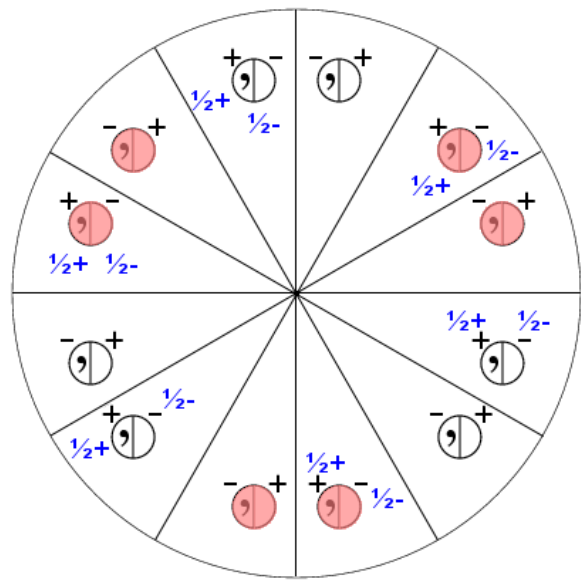
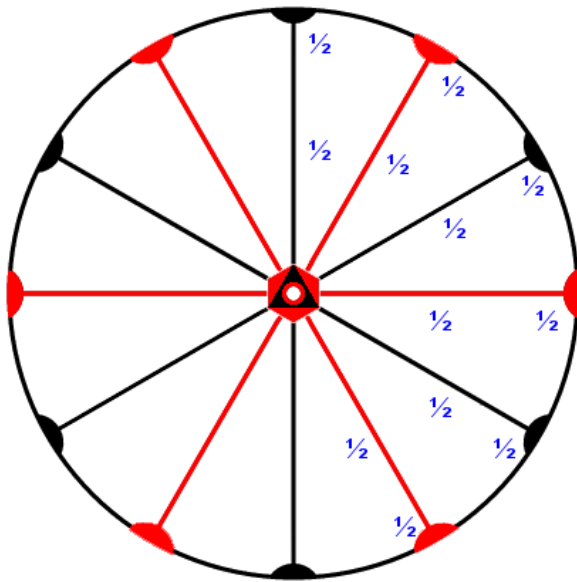

26.2.3.287

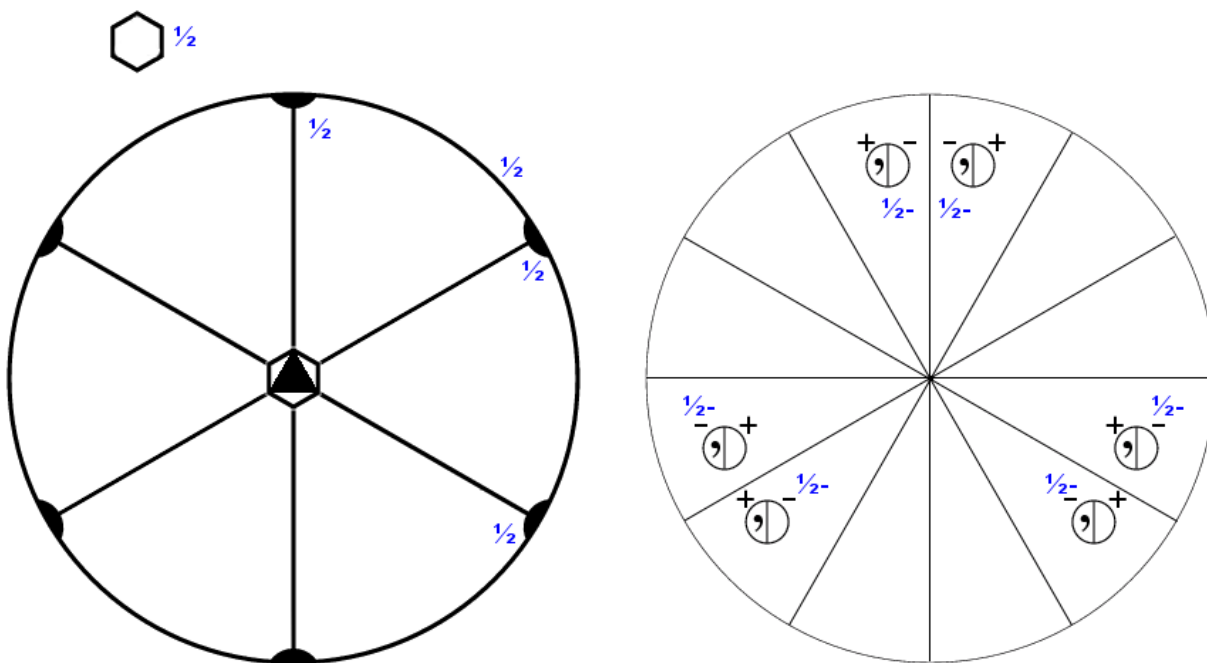

26.3.1.288

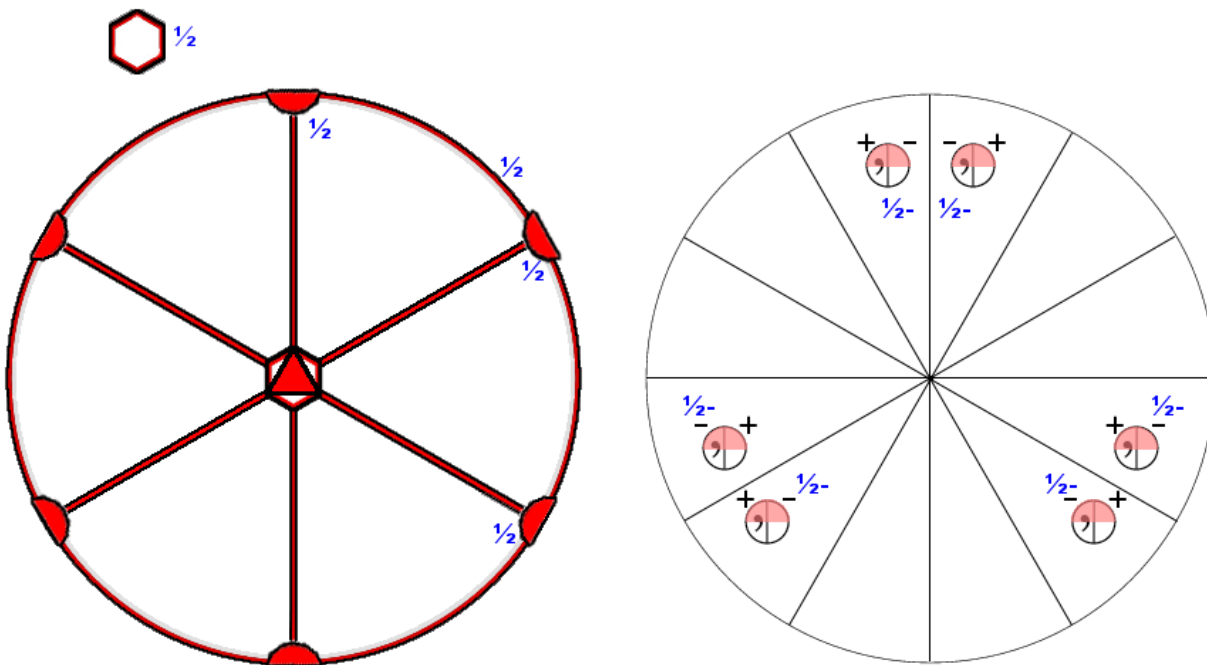

26.3.2.289

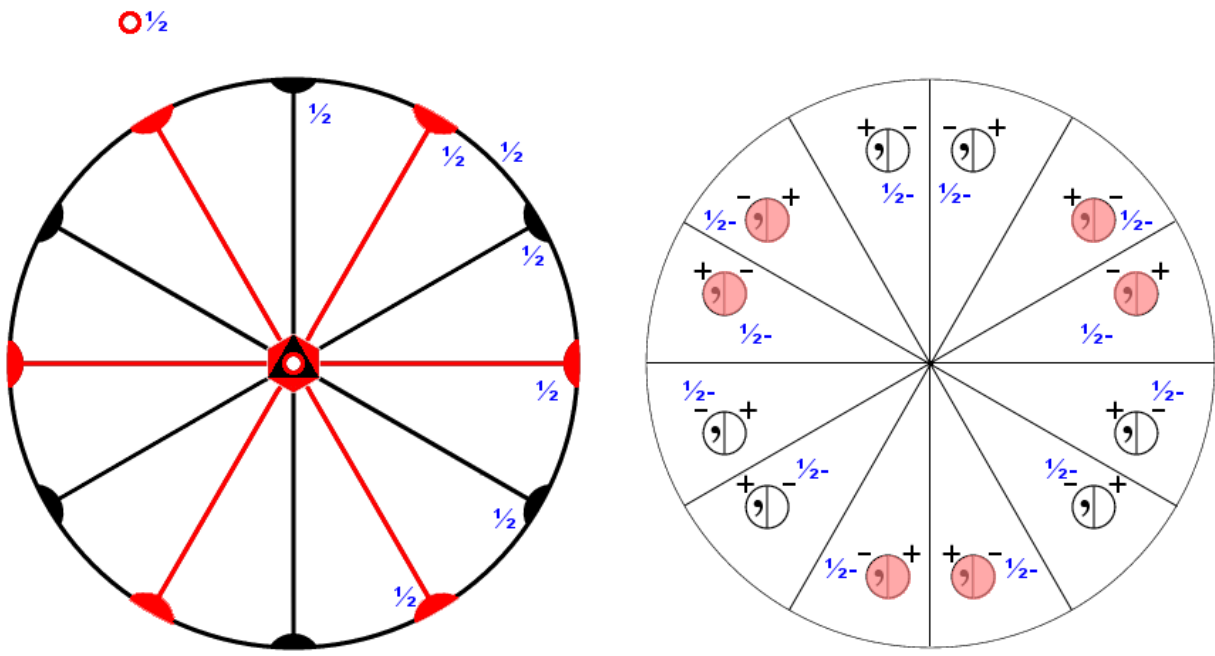

26.3.3.290

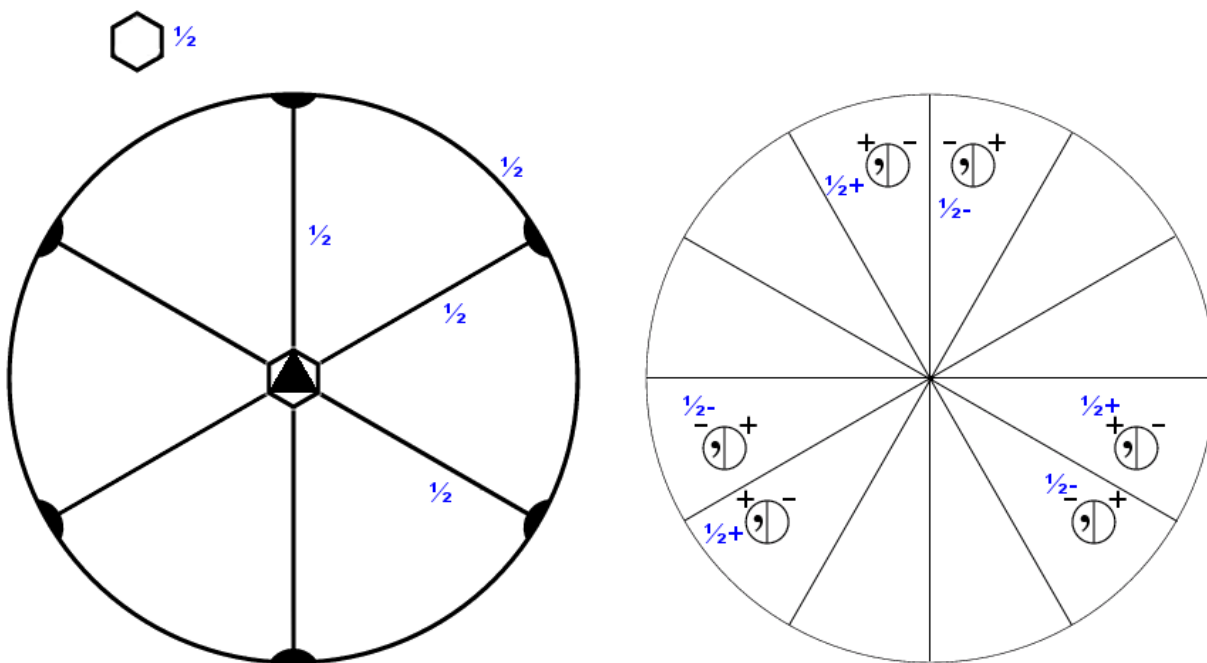

26.4.1.291

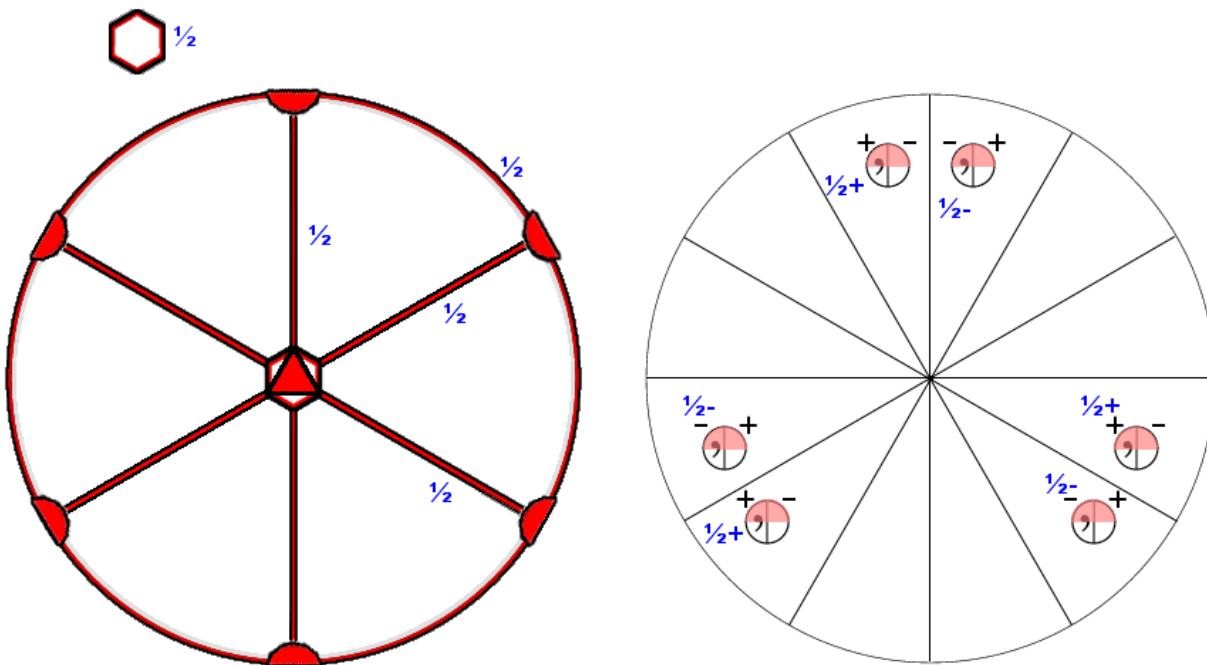

26.4.2.292

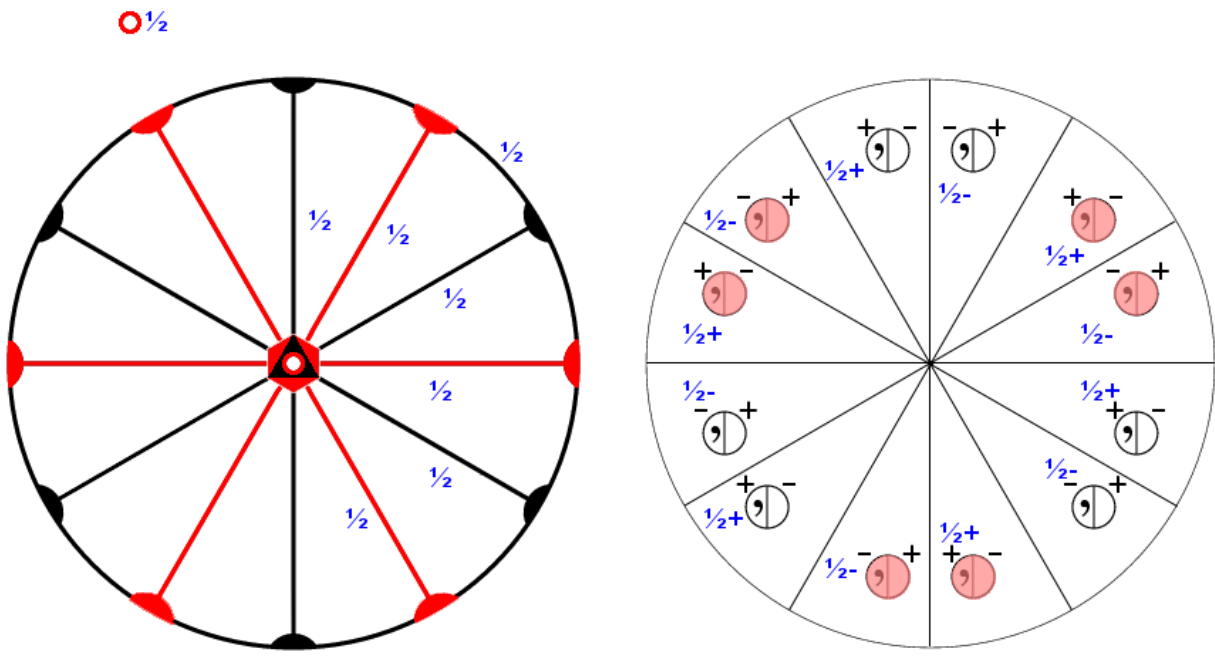

26.4.3.293

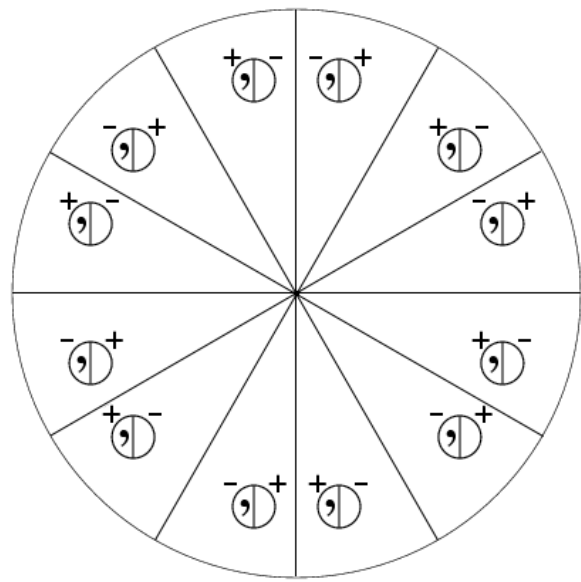
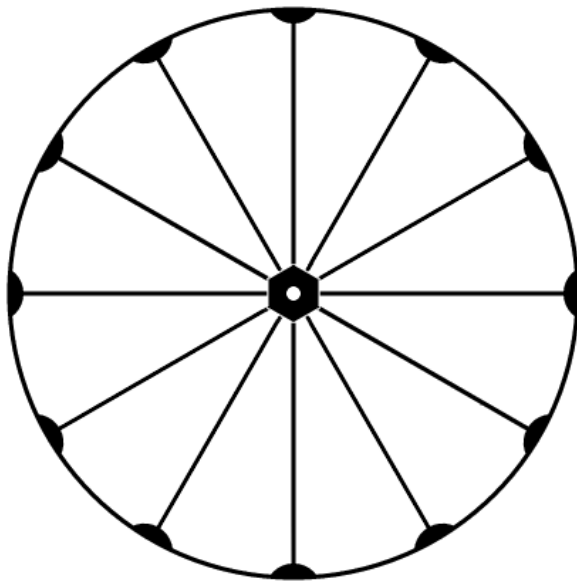

27.1.1.294

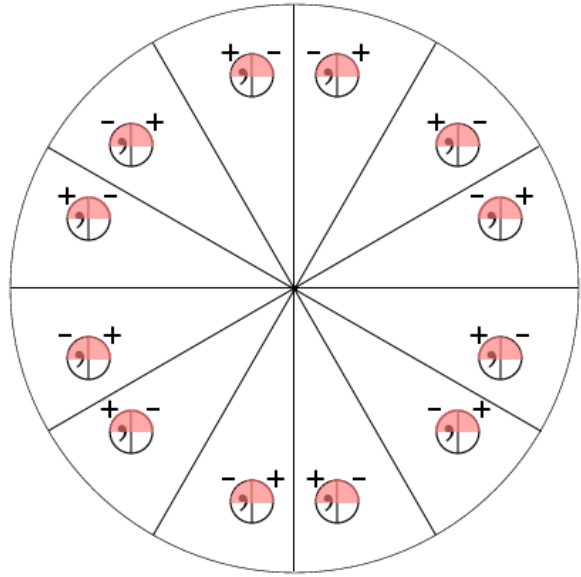
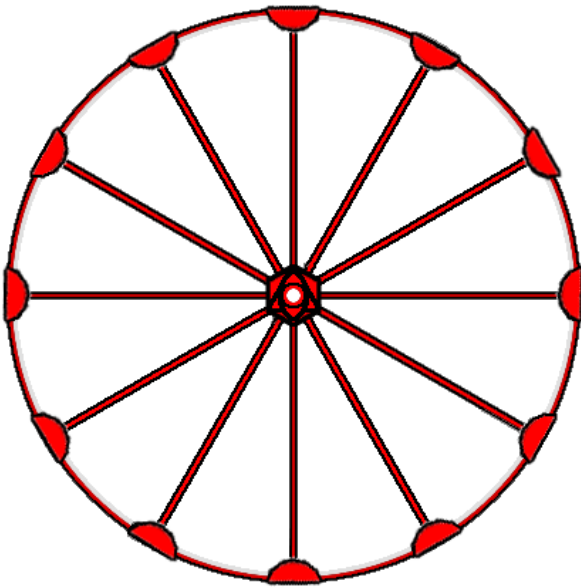

27.1.2.295

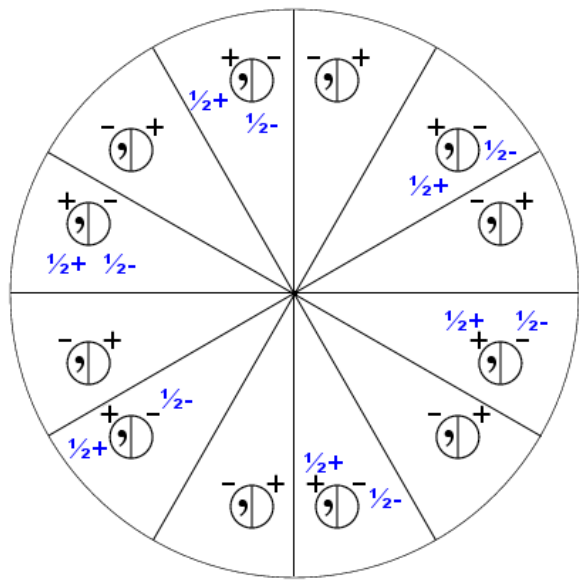
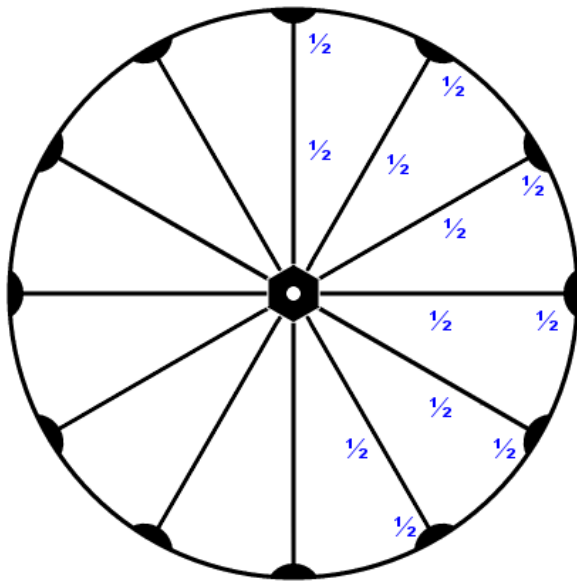

27.2.1.296

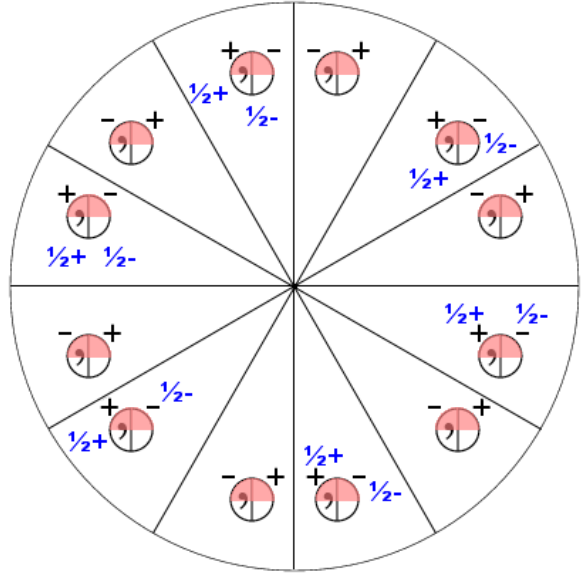
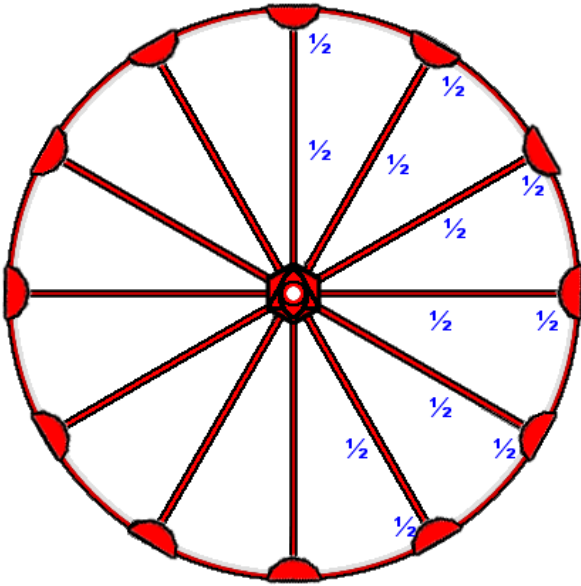

27.2.2.297

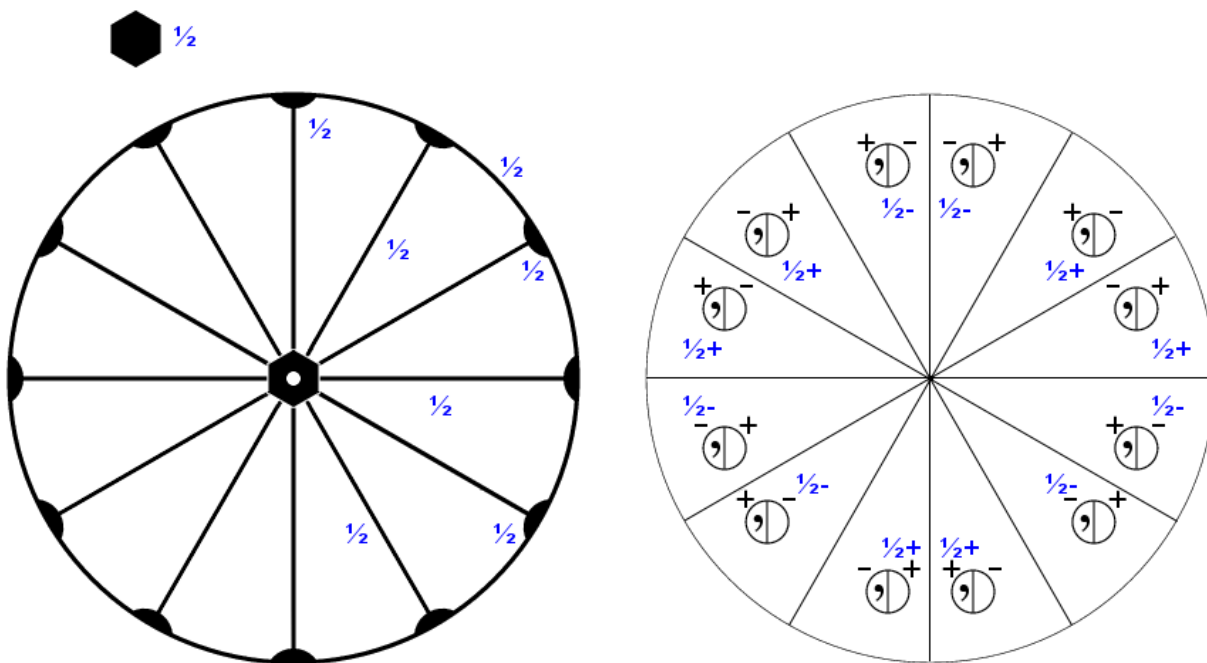

27.3.1.298

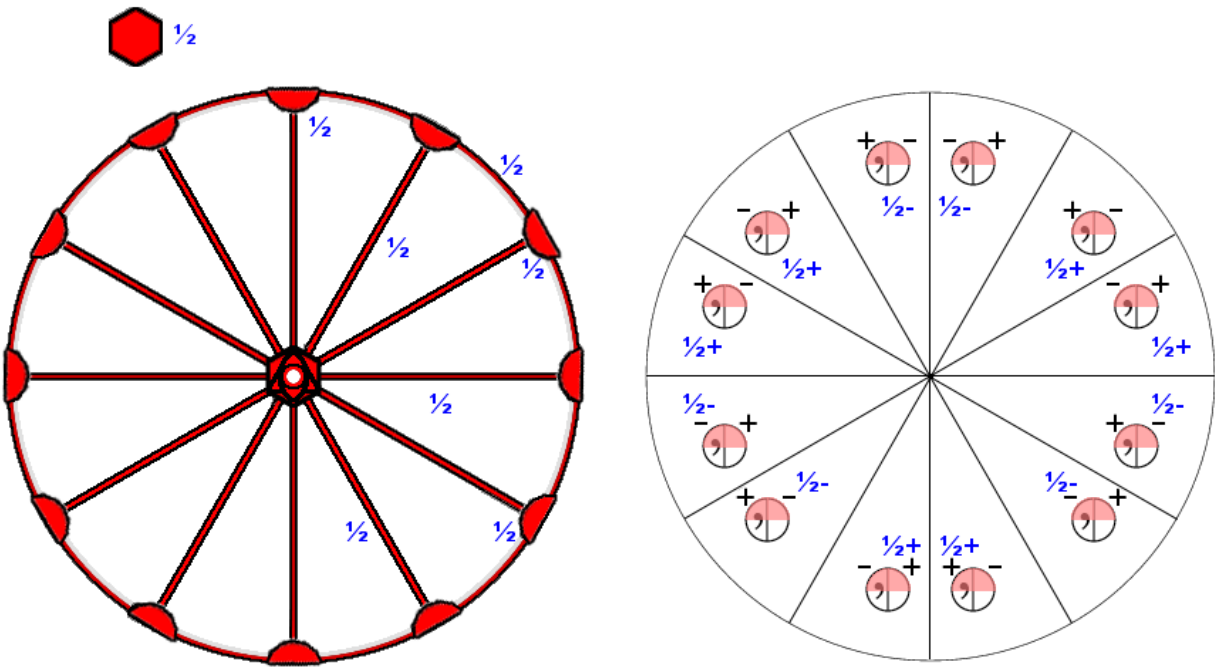

27.3.2.299

$\circ \frac{1}{2}$

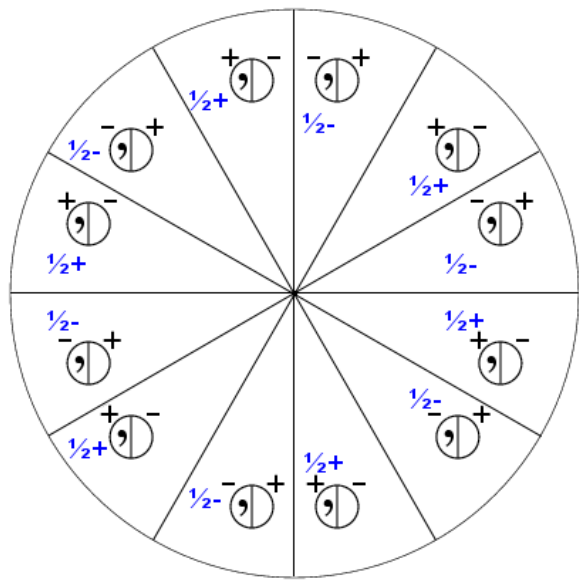
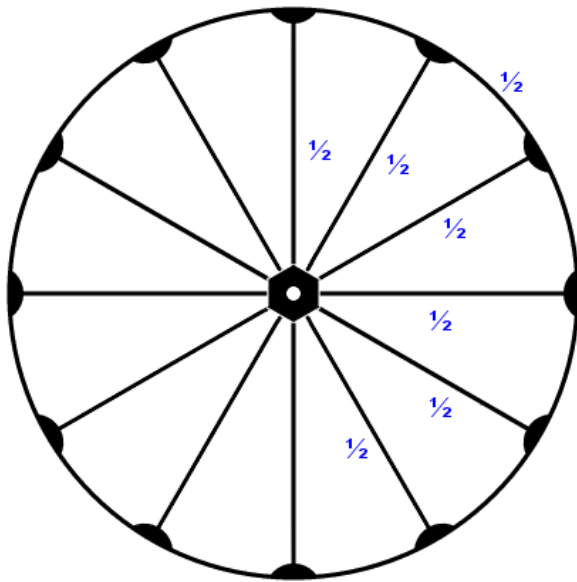

27.4.1.300

$\odot \frac{1}{2}$

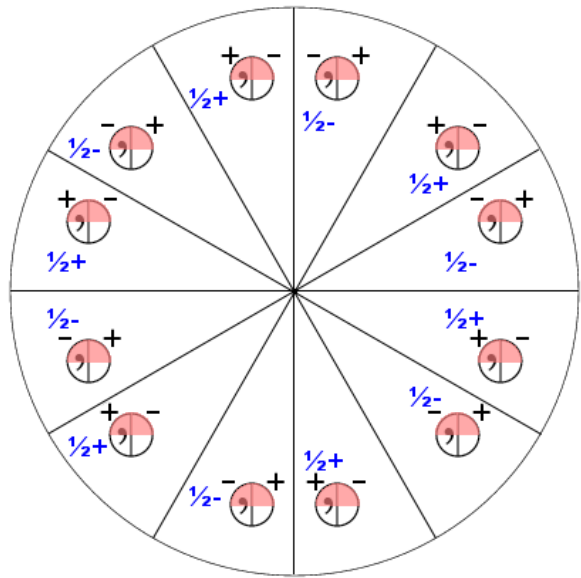
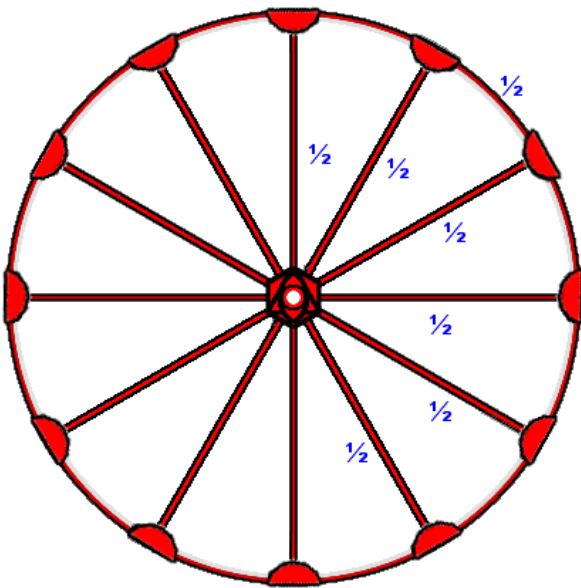

27.4.2.301

$\circ \frac{1}{2}$

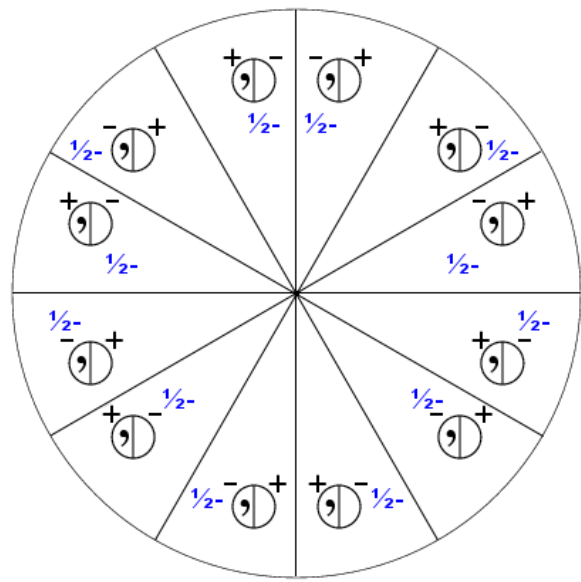
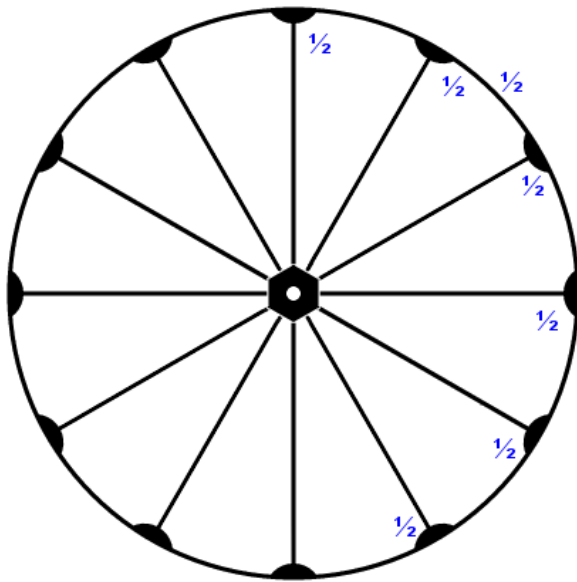

27.5.1.302

$\odot \frac{1}{2}$

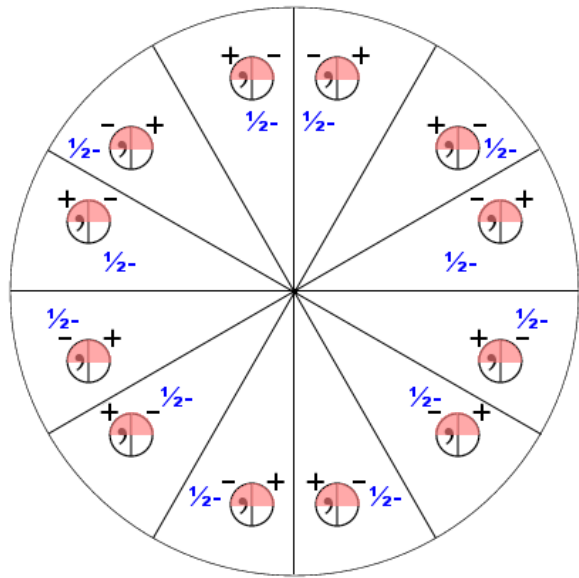
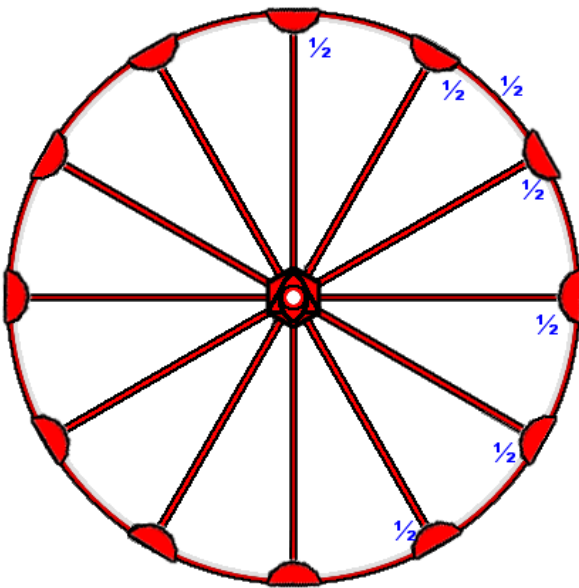

27.5.2.303

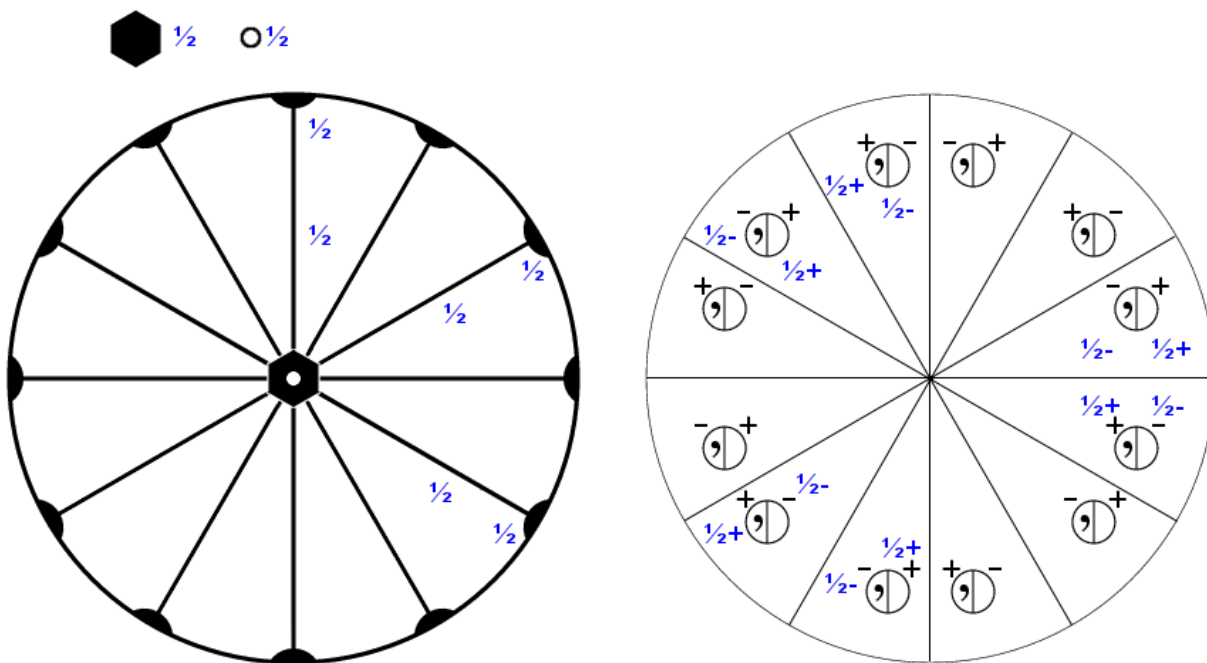

27.6.1.304

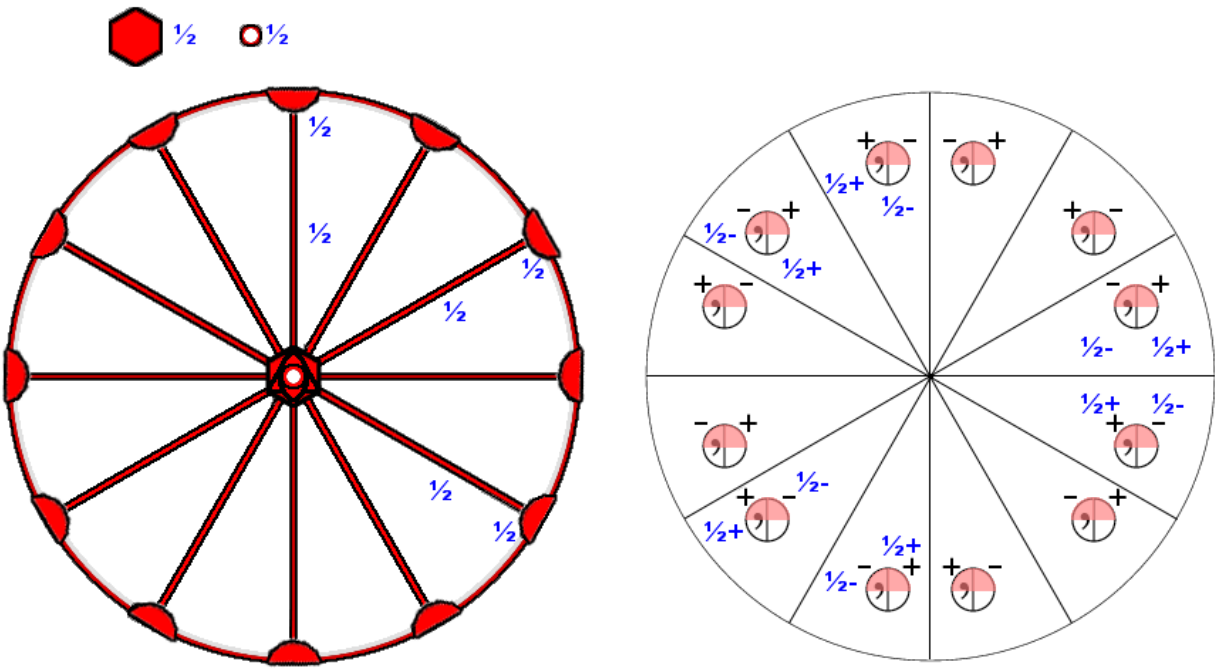

27.6.2.305

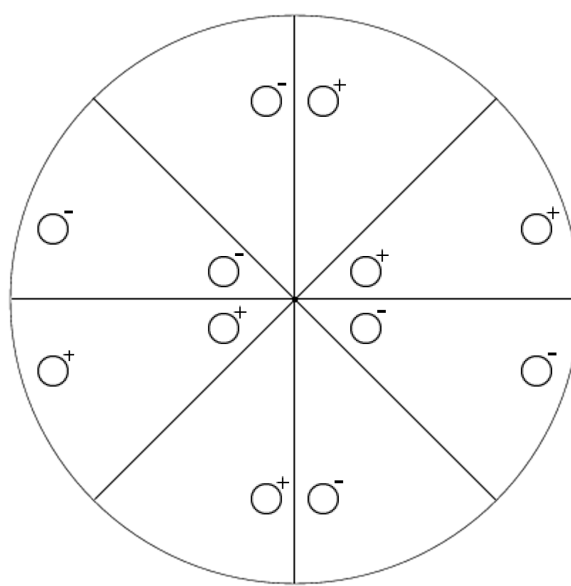
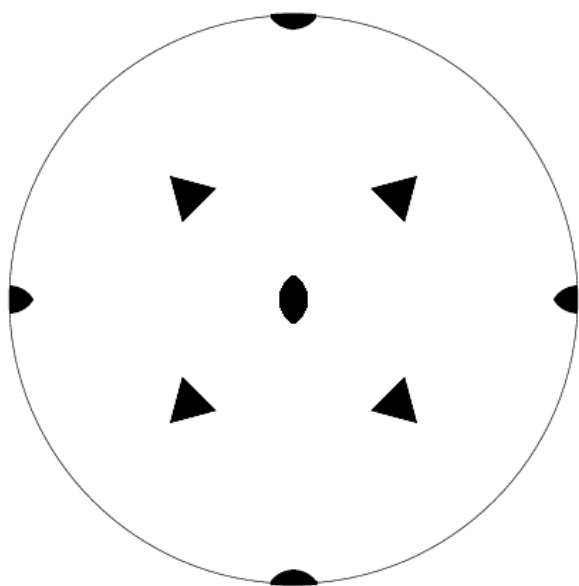

28.1.1.306

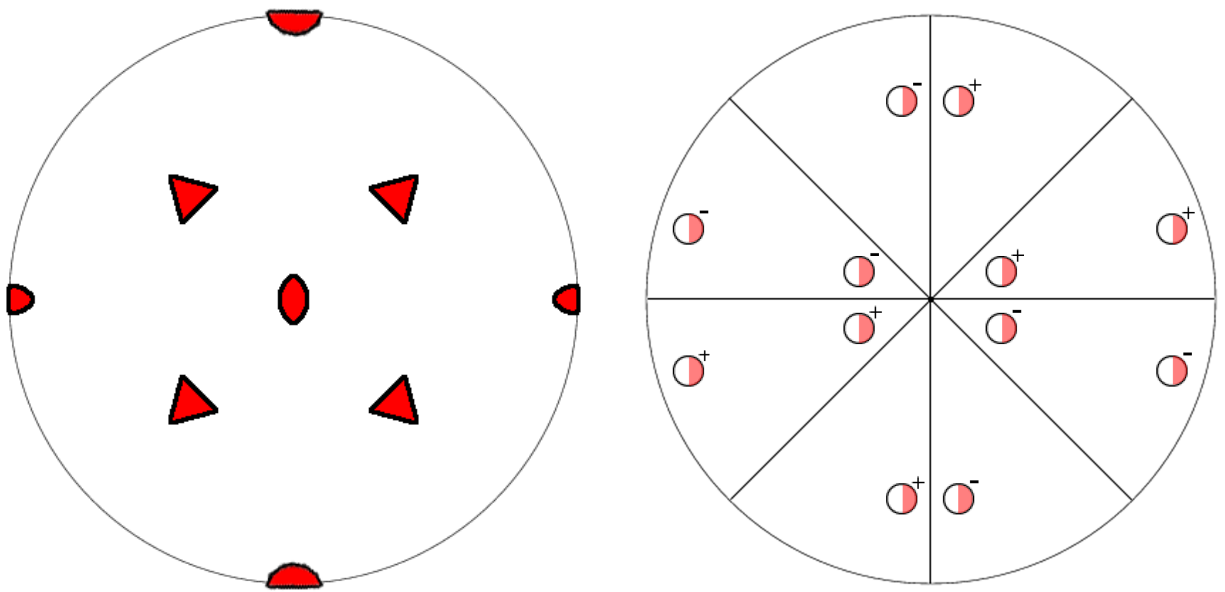

28.1.2.307

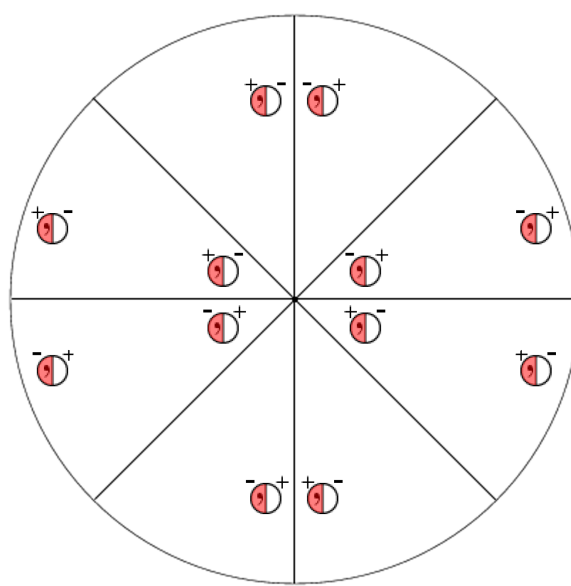
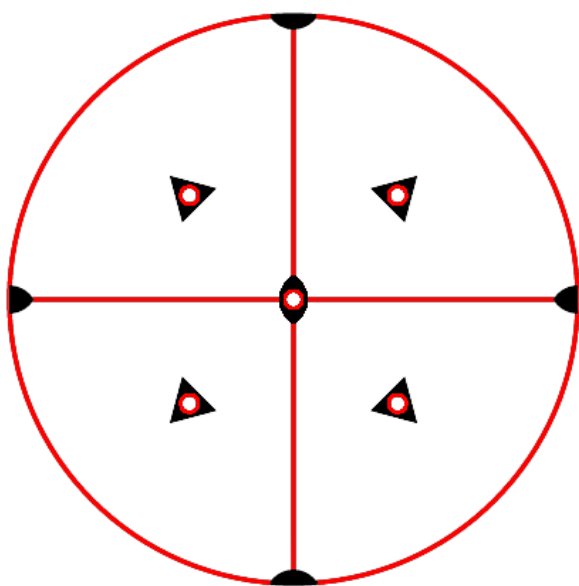

28.1.3.308

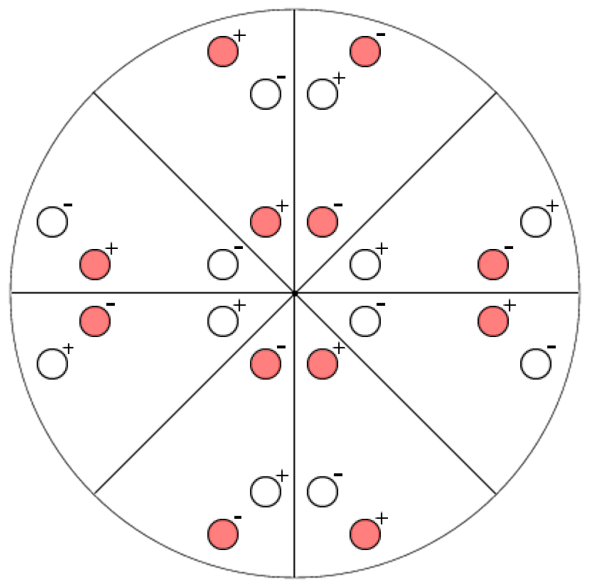
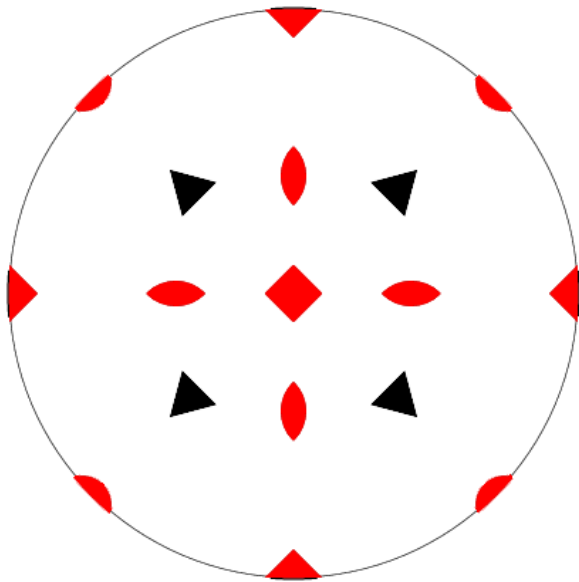

28.1.4.309

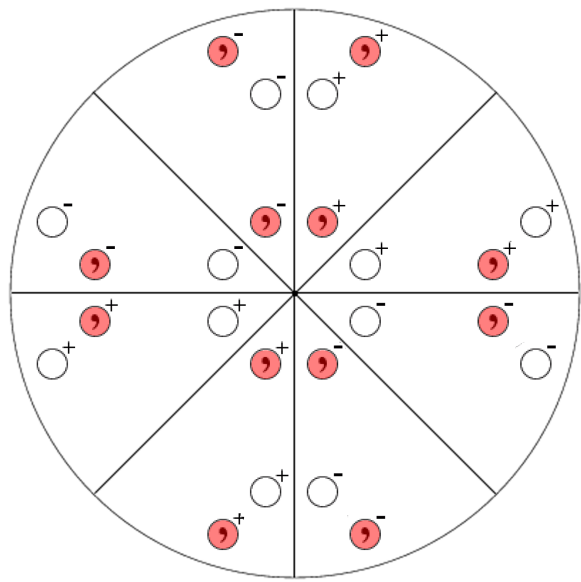
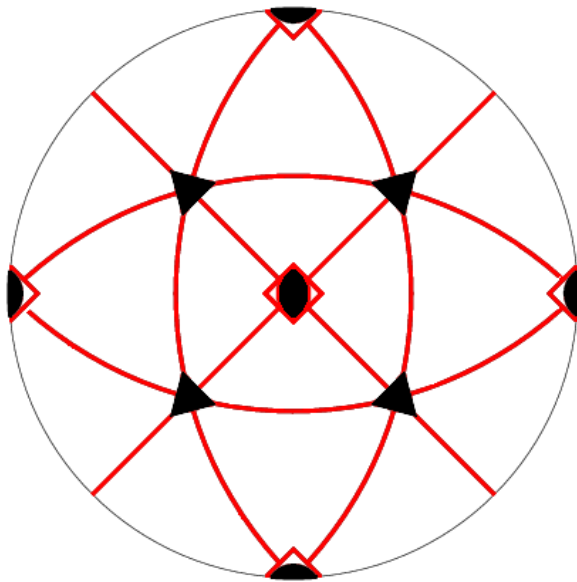

28.1.5.310

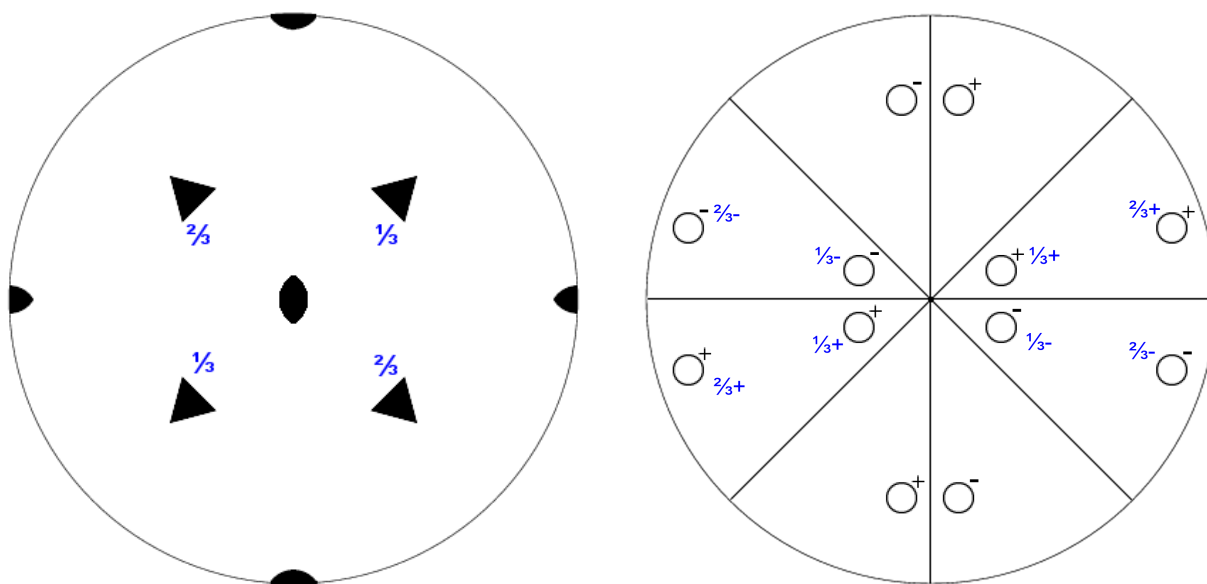

28.2.1.311

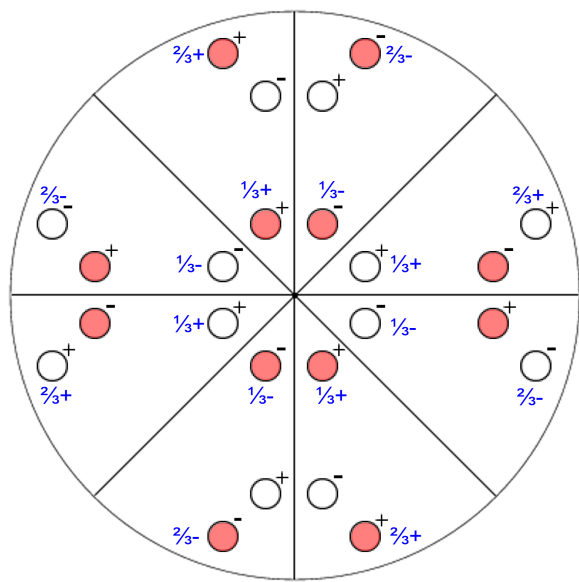
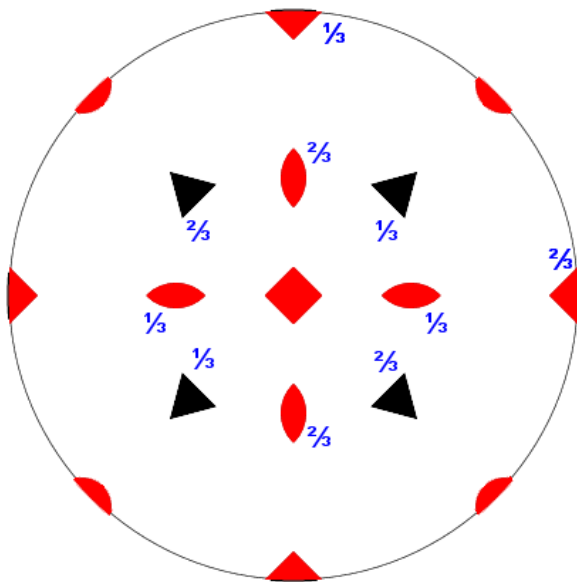

28.2.2.312

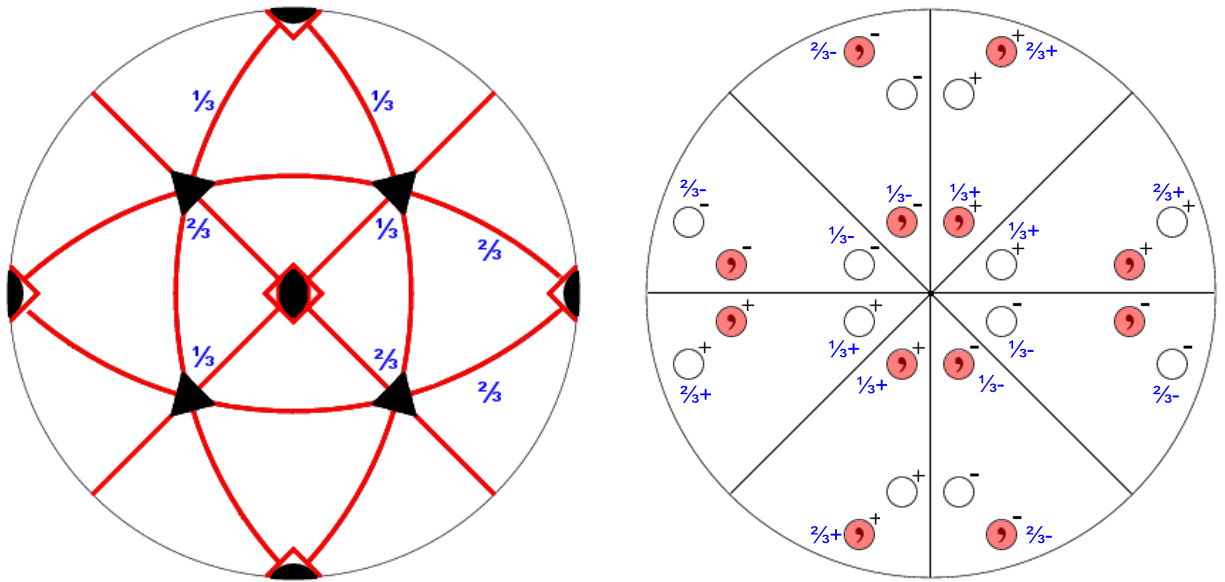

28.2.3.313

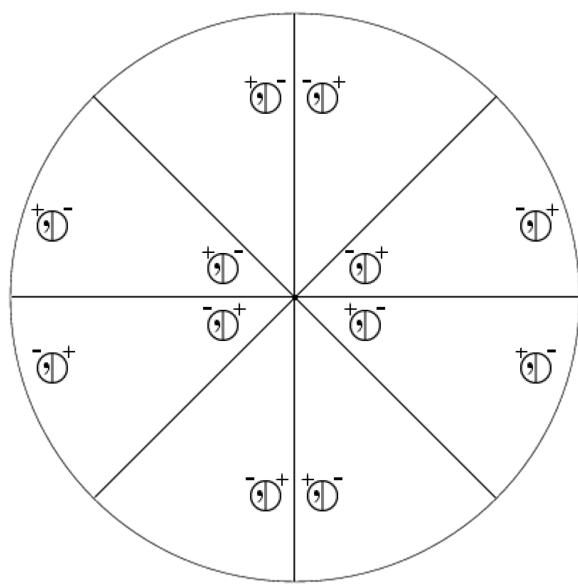
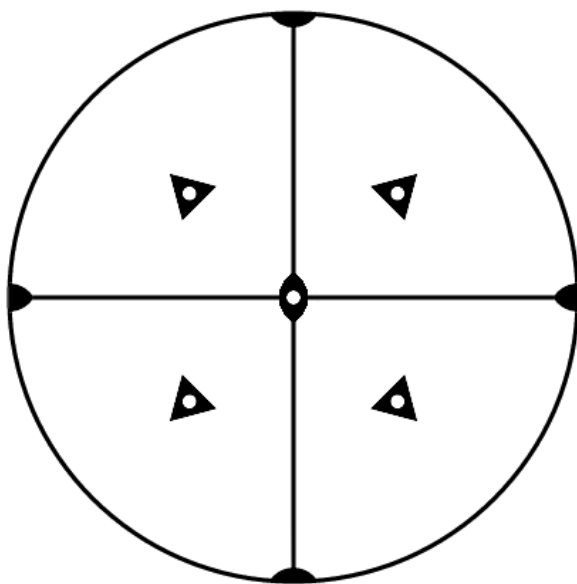

29.1.1.314

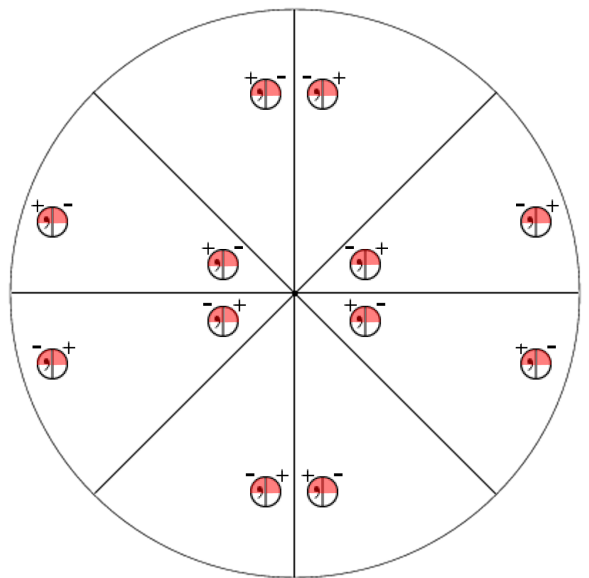
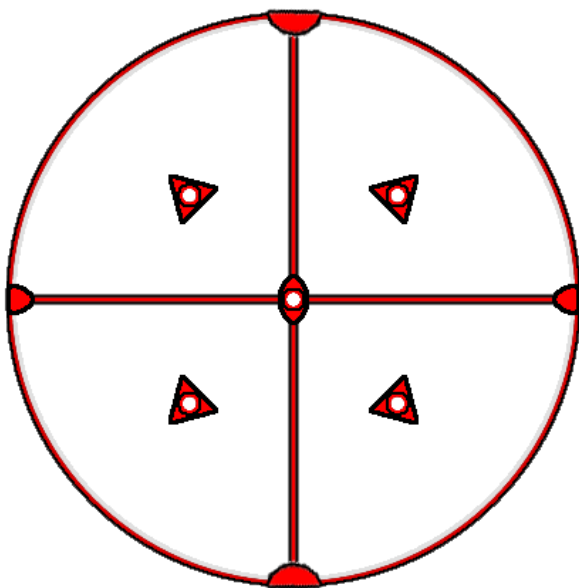

29.1.2.315

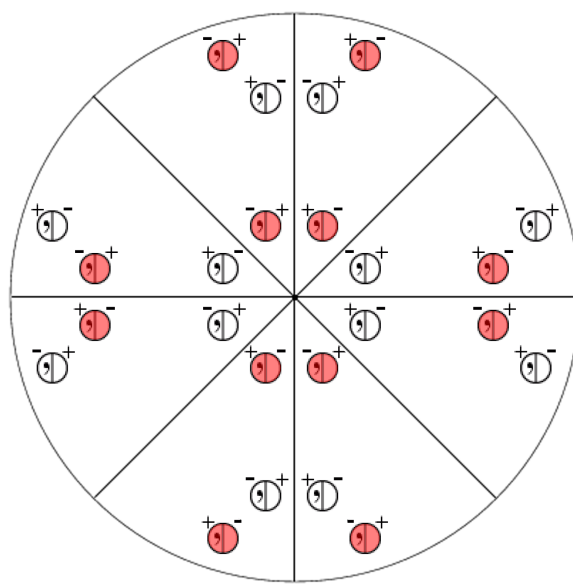
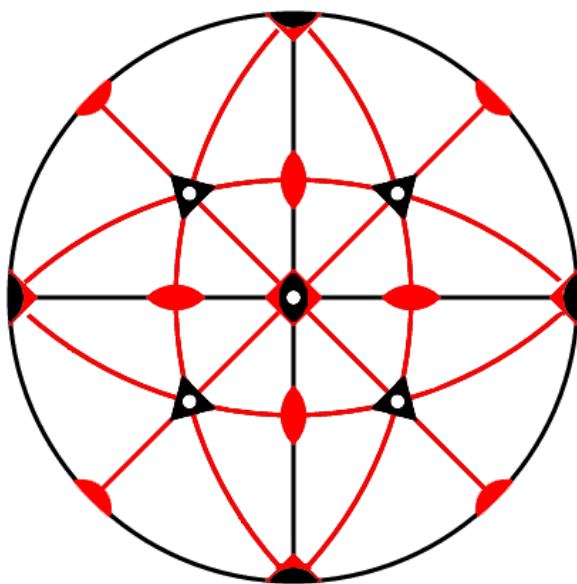

29.1.3.316

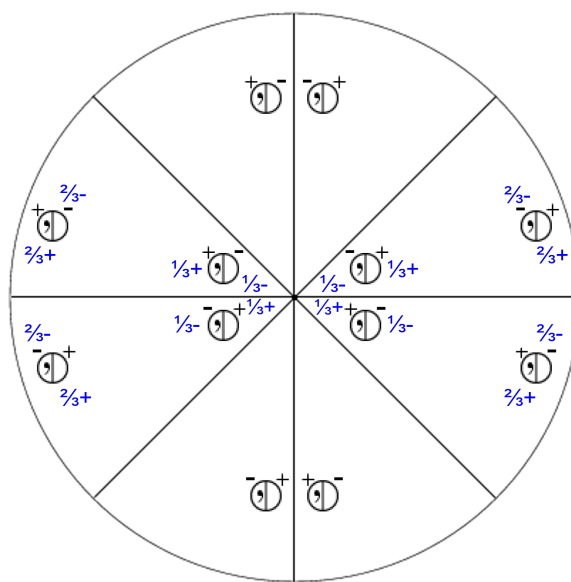
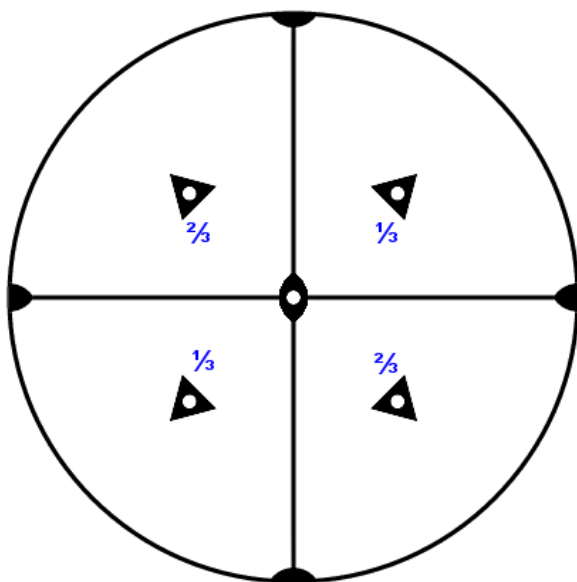

29.2.1.317

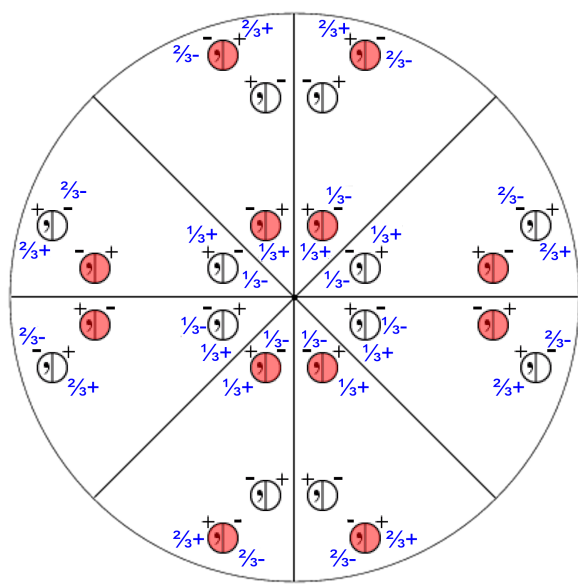
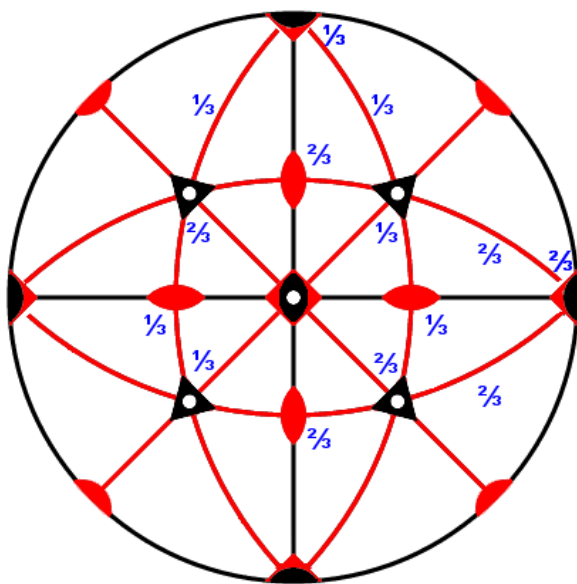

29.2.2.318

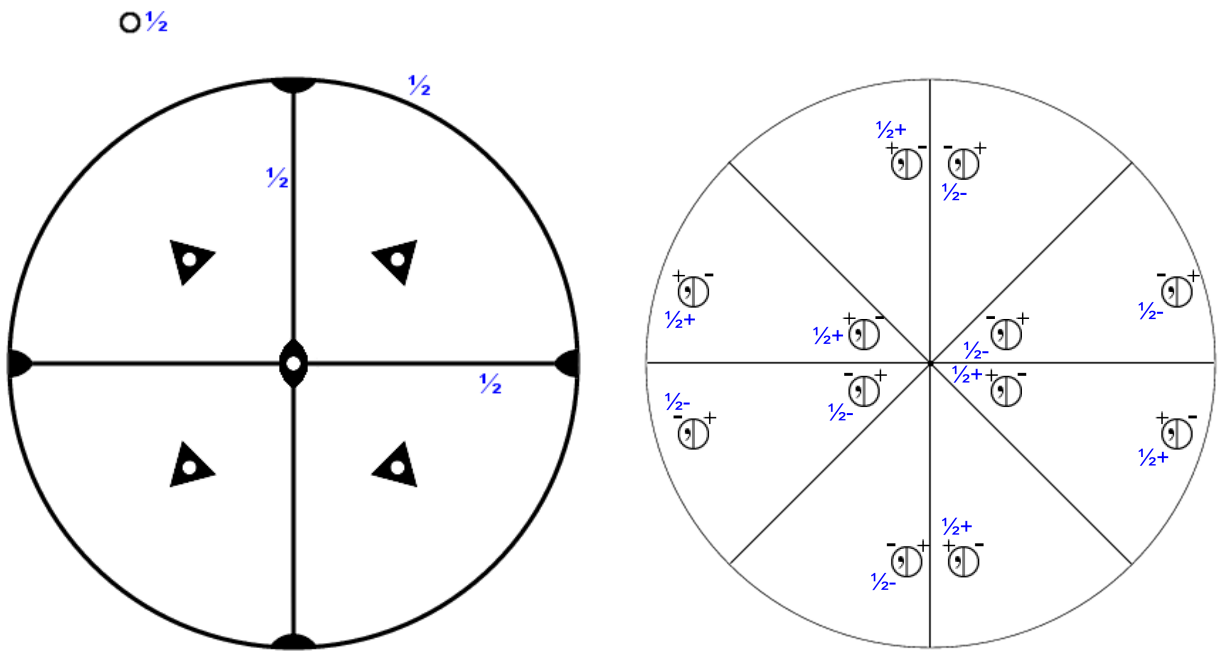

29.3.1.319

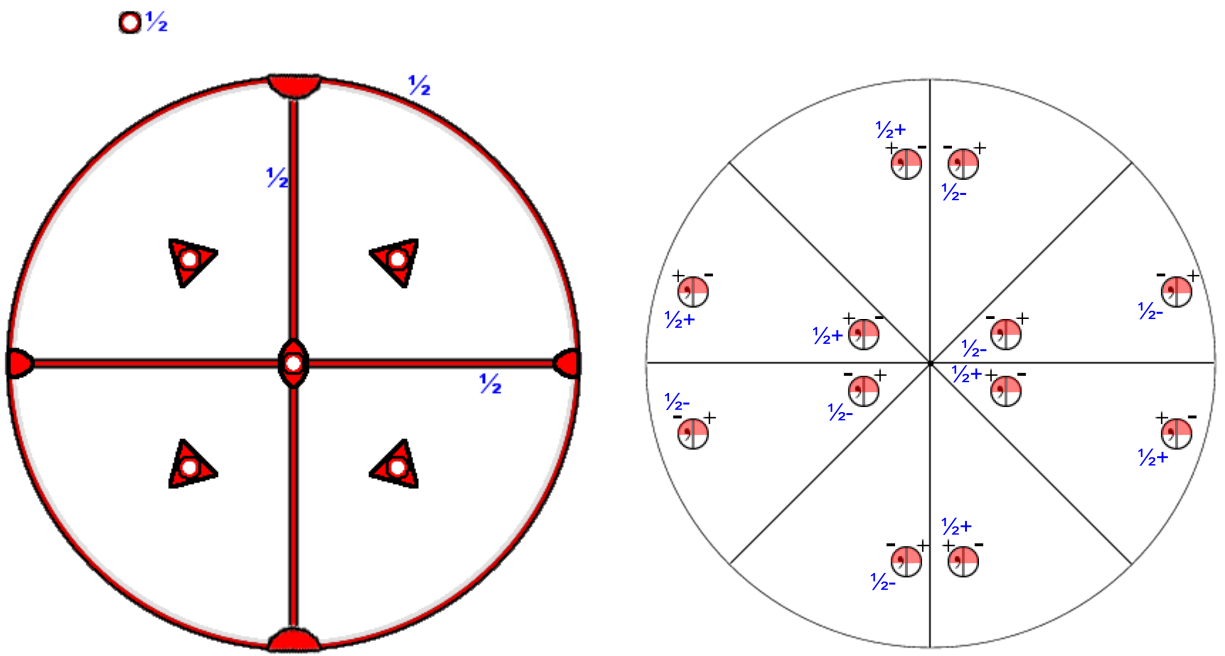

29.3.2.320

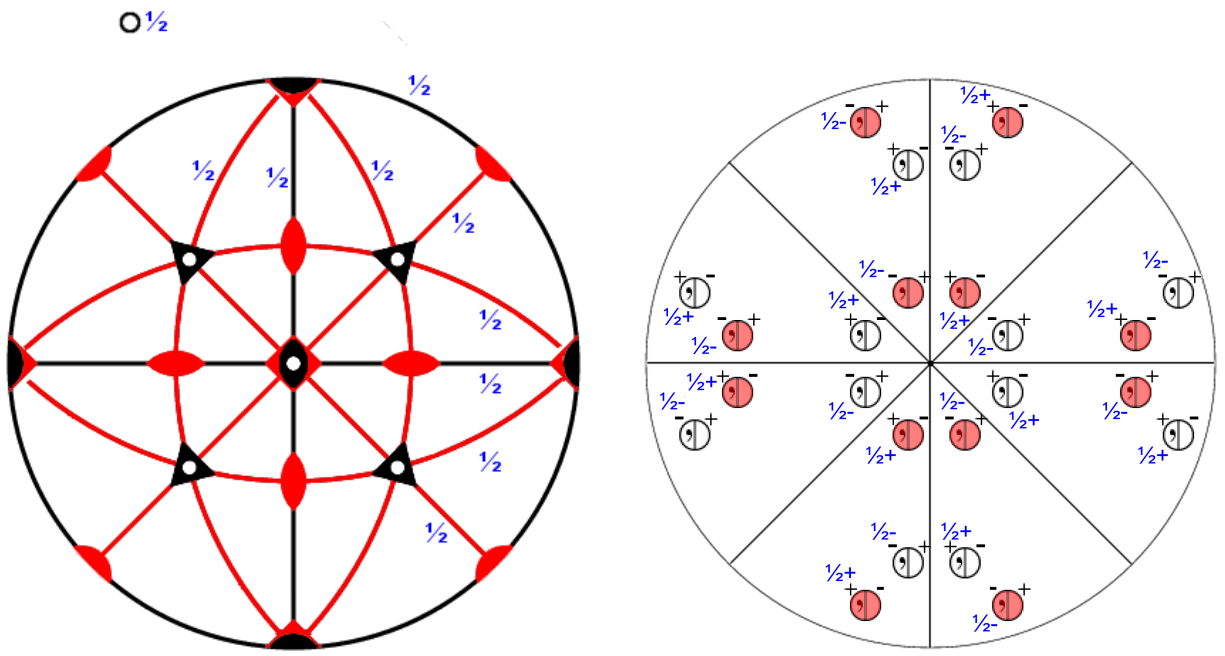

29.3.3.321

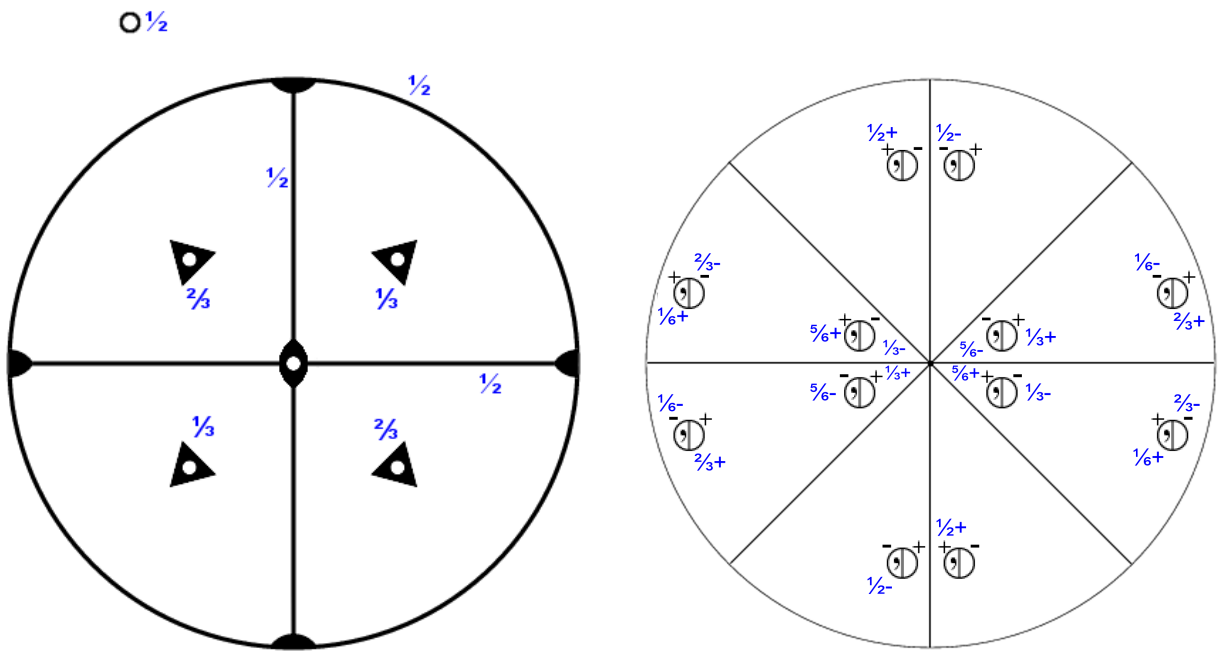

29.4.1.322

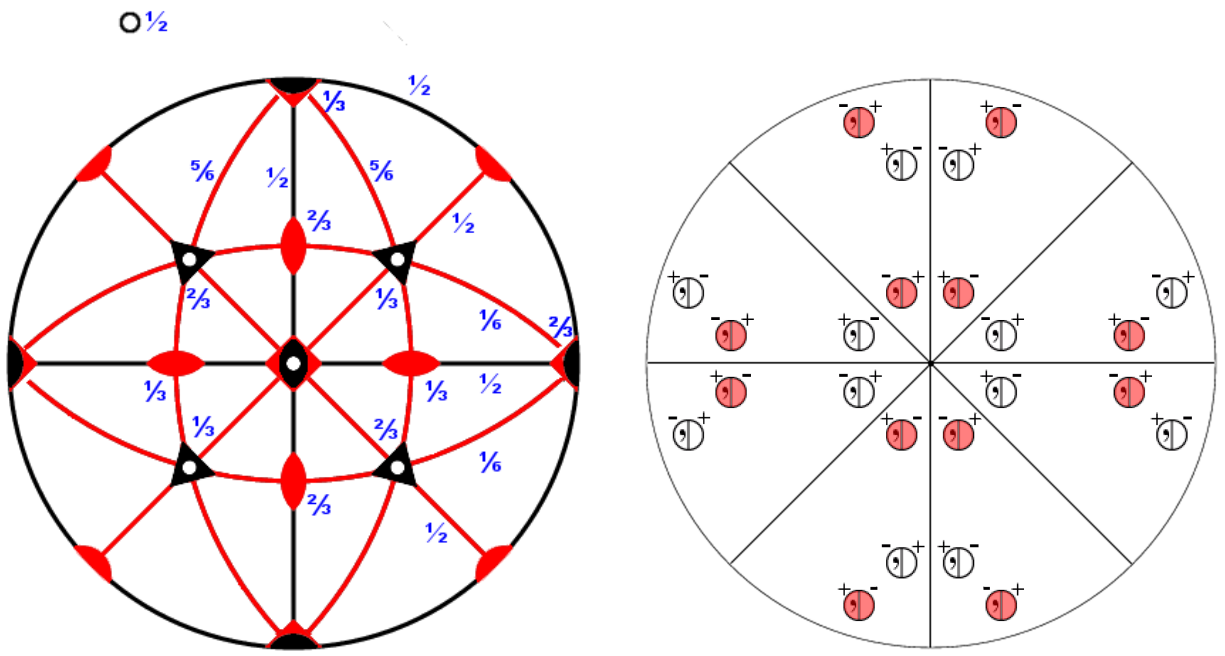

29.4.2.323

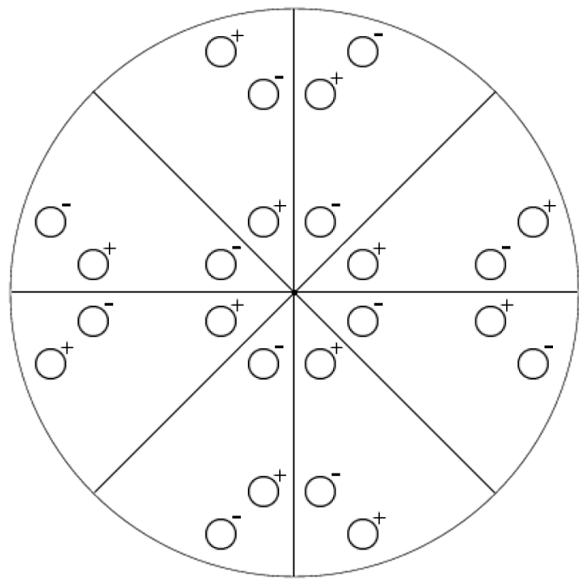
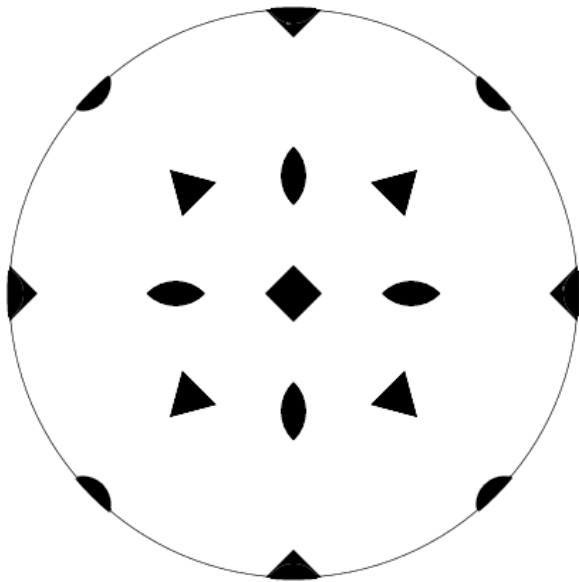

30.1.1.324

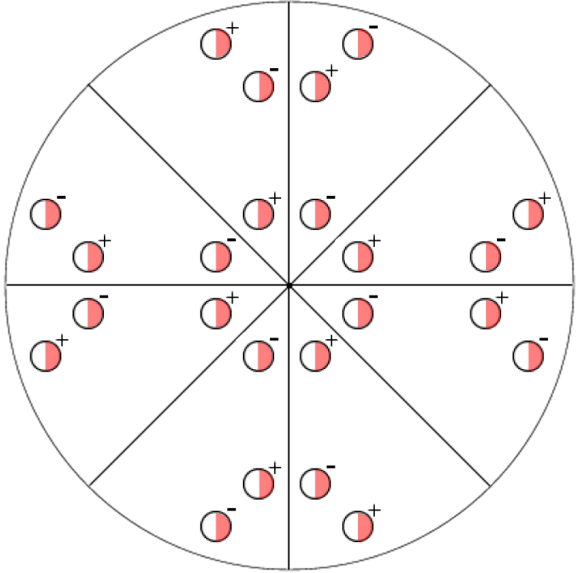
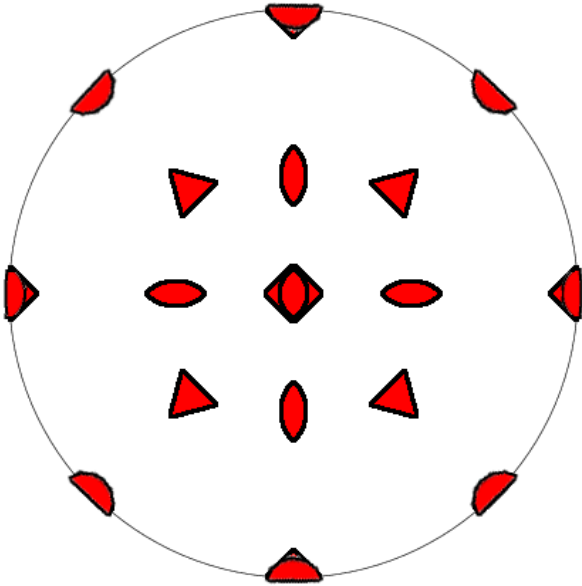

30.1.2.325

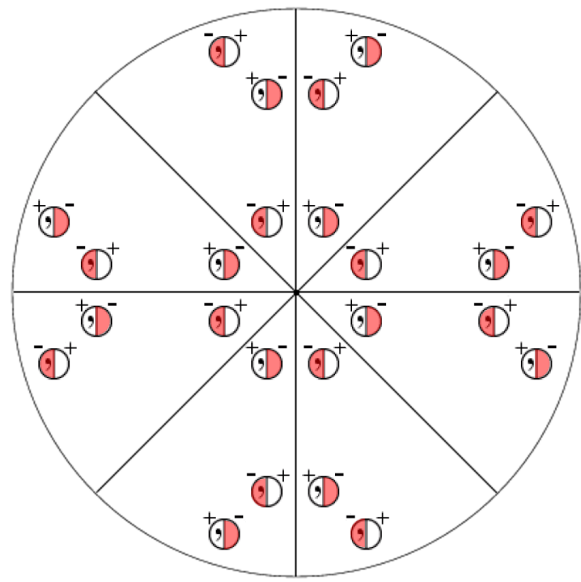
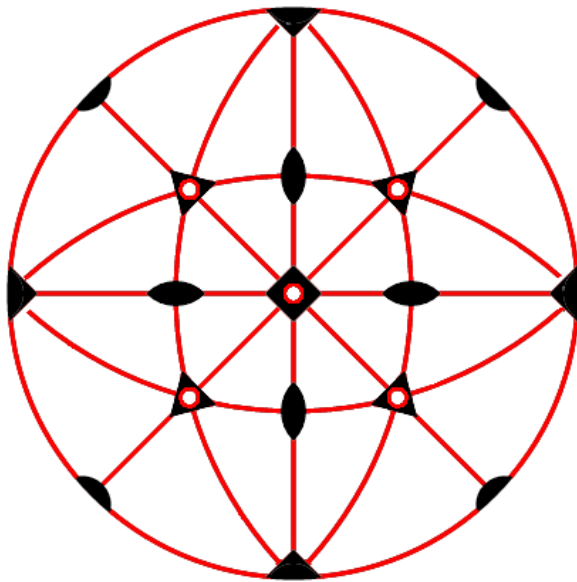

30.1.3.326

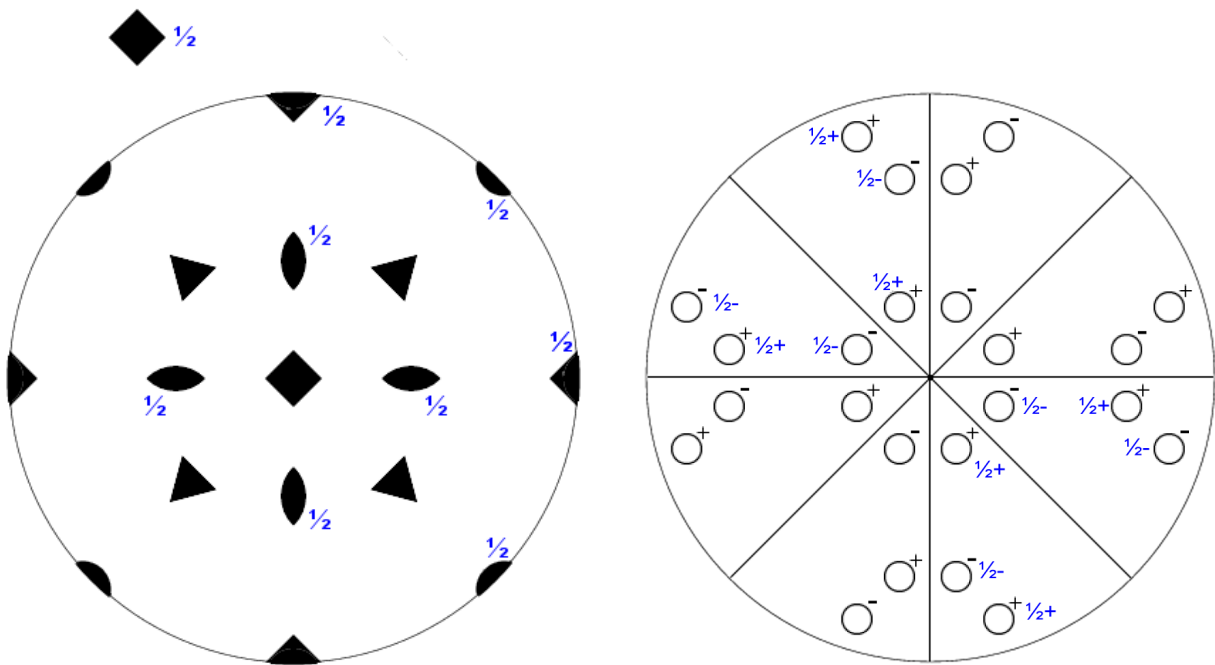

30.2.1.327

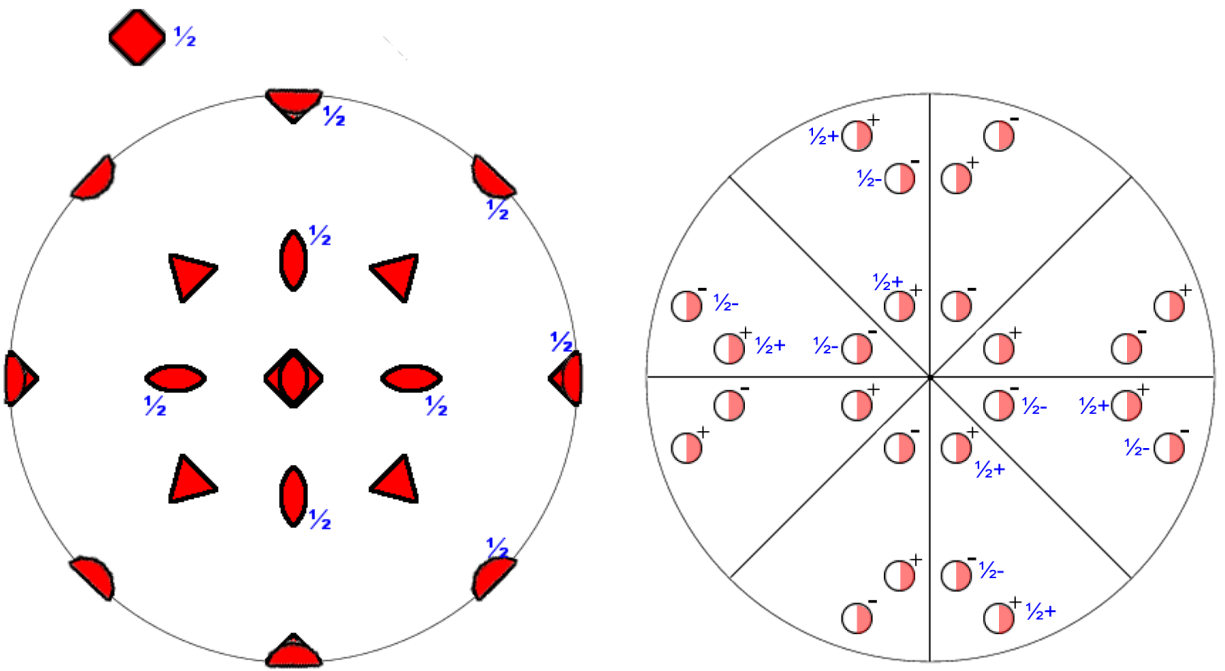

30.2.2.328

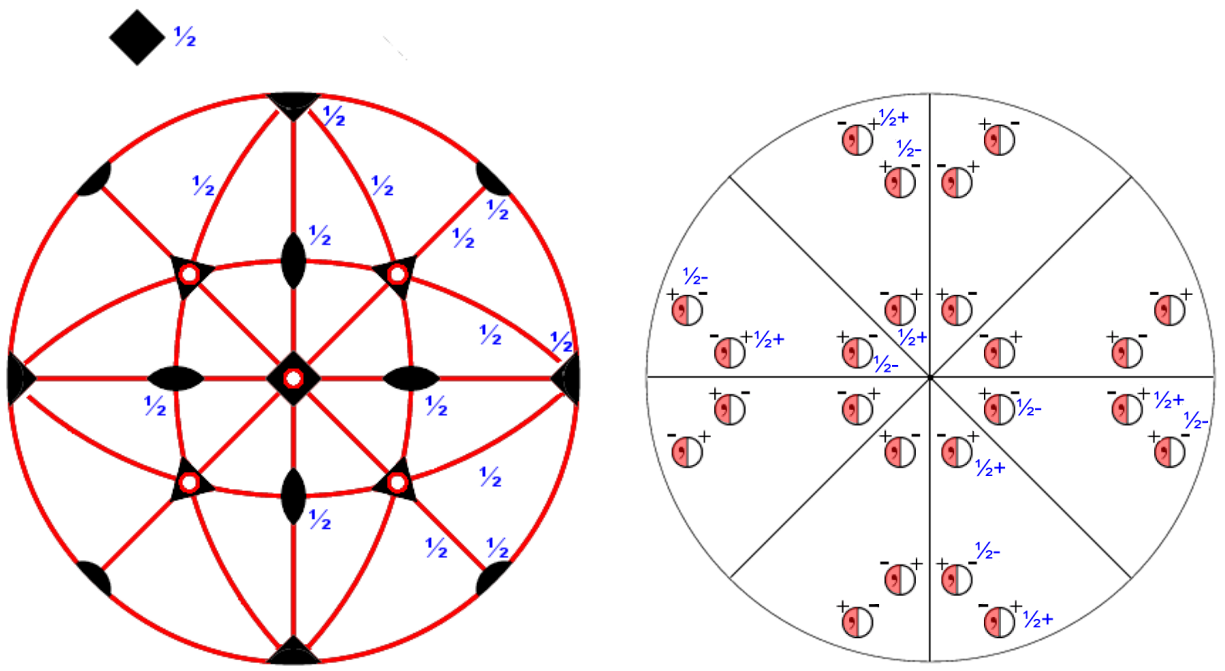

30.2.3.329

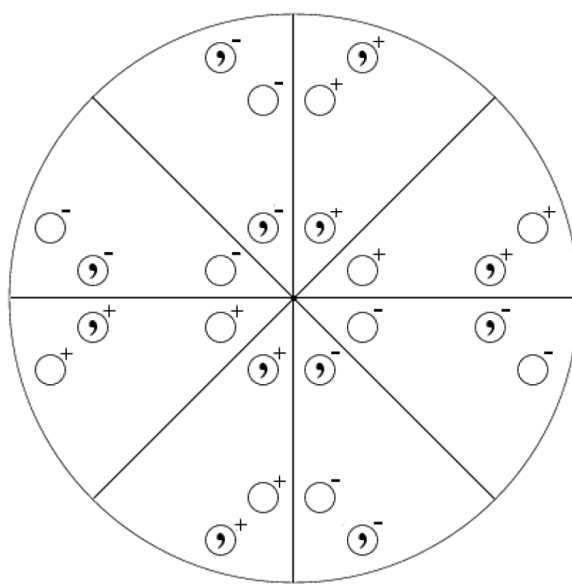
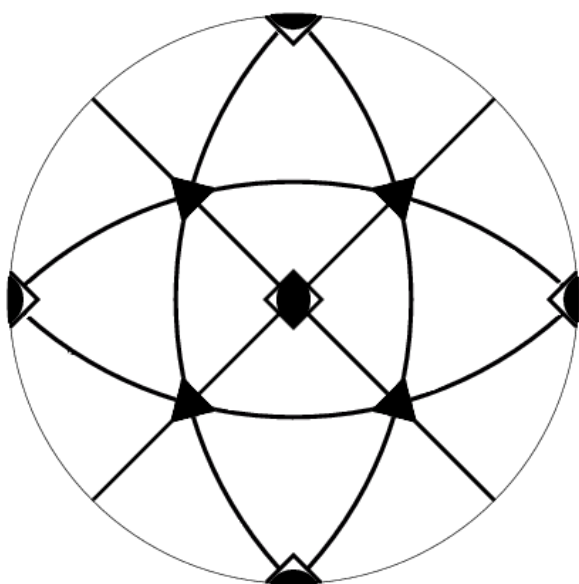

31.1.1.330

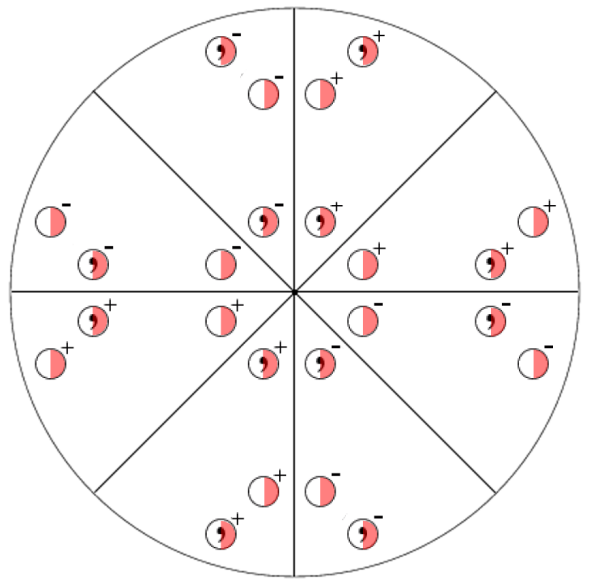
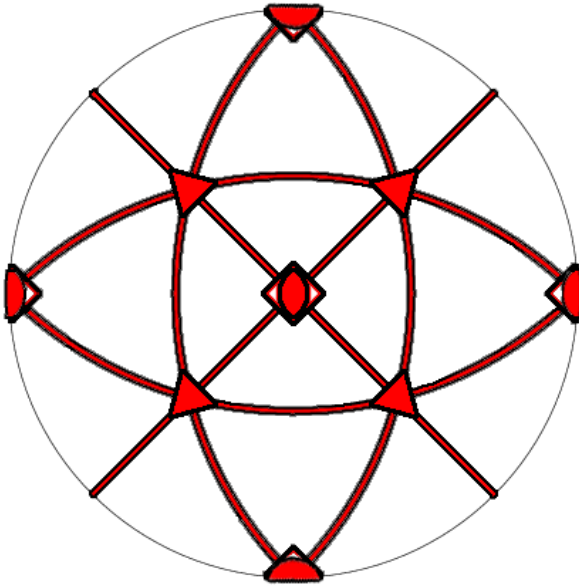

31.1.2.331

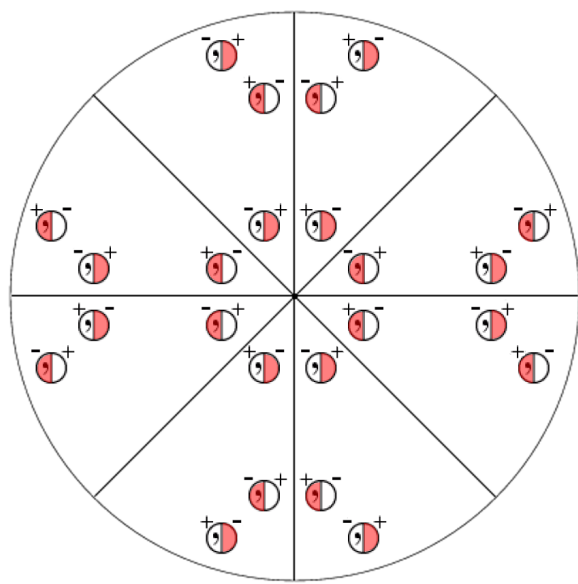
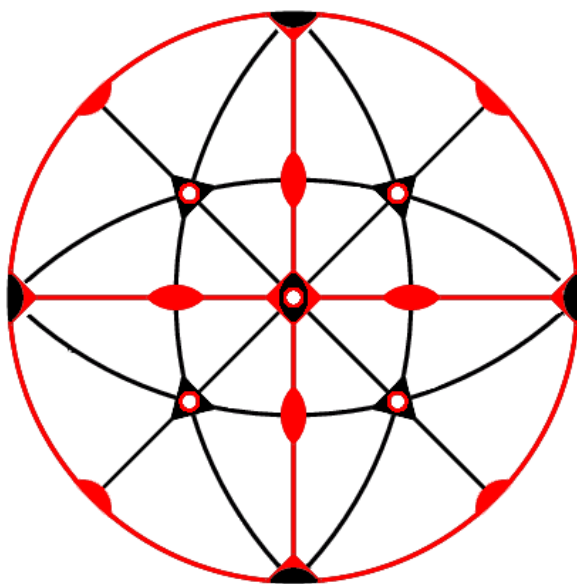

31.1.3.332

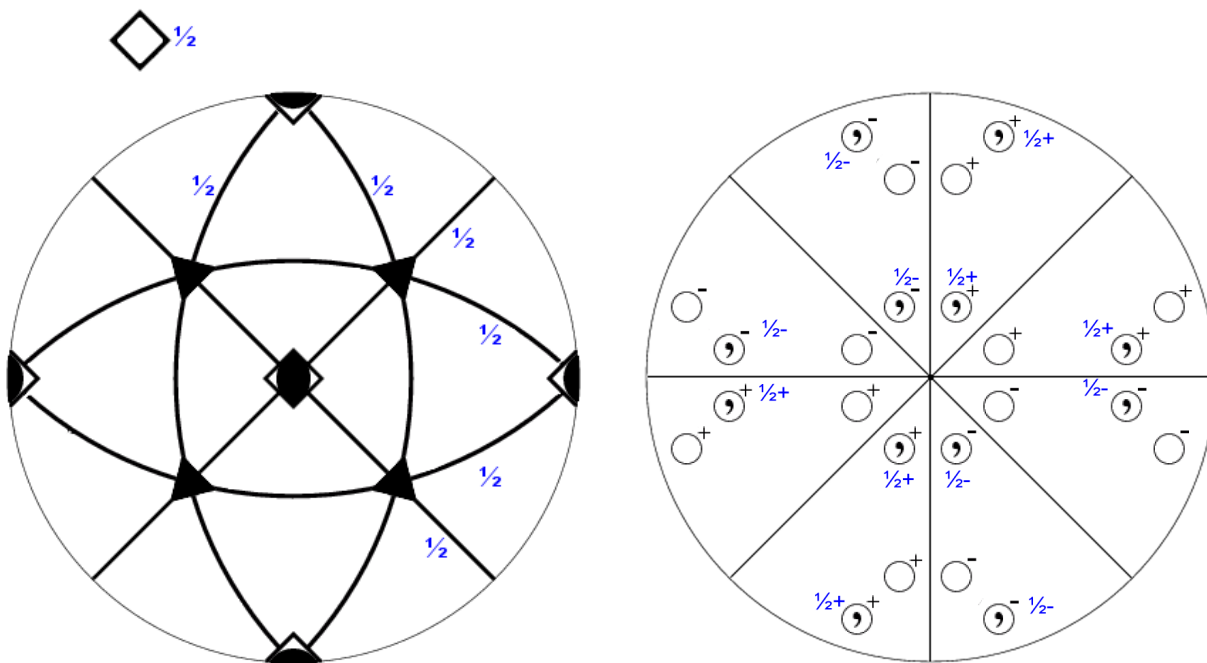

31.2.1.333

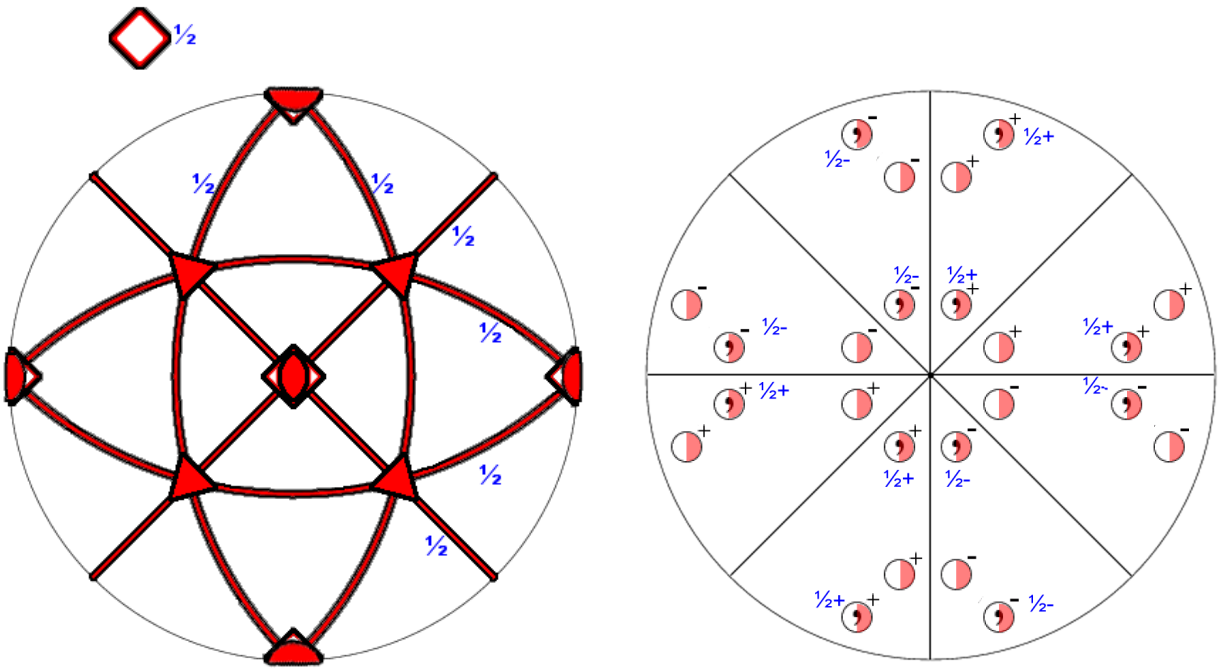

31.2.2.334

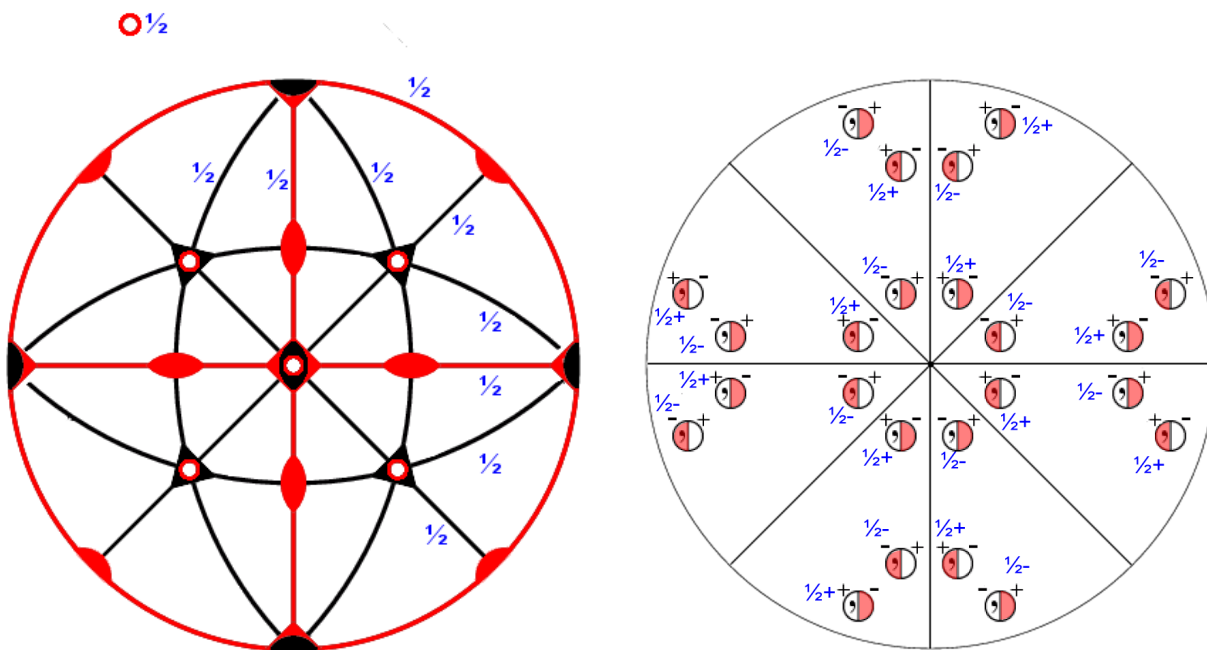

31.2.3.335

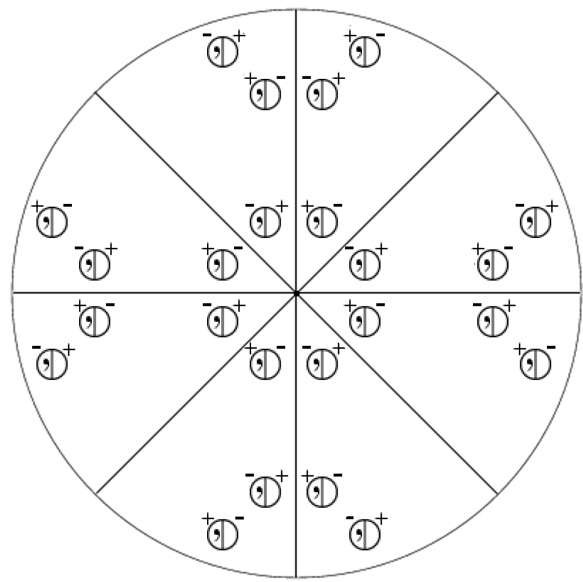
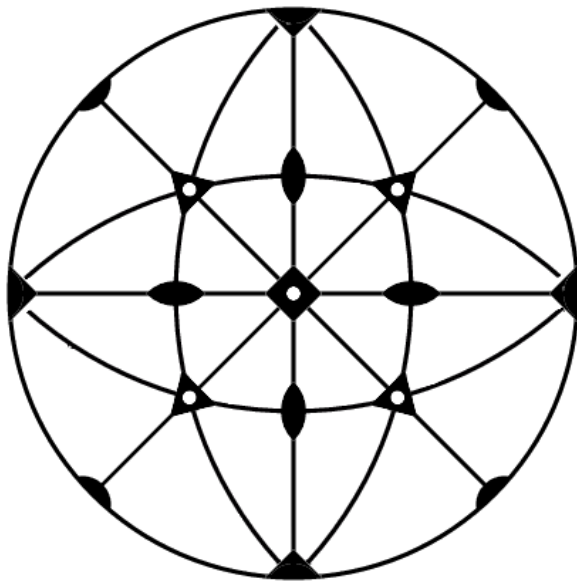

32.1.1.336

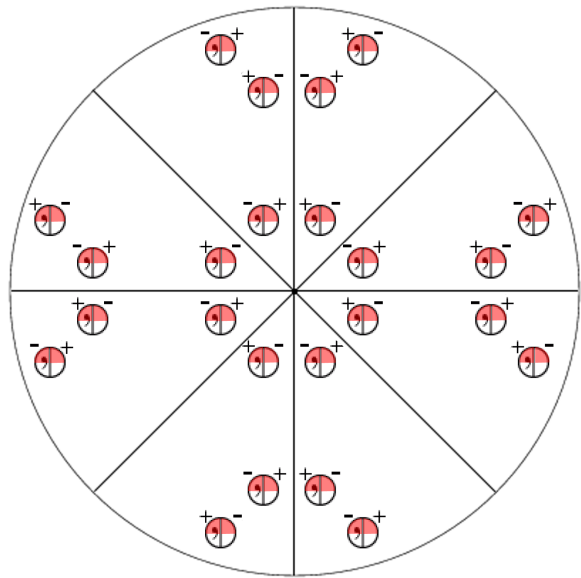
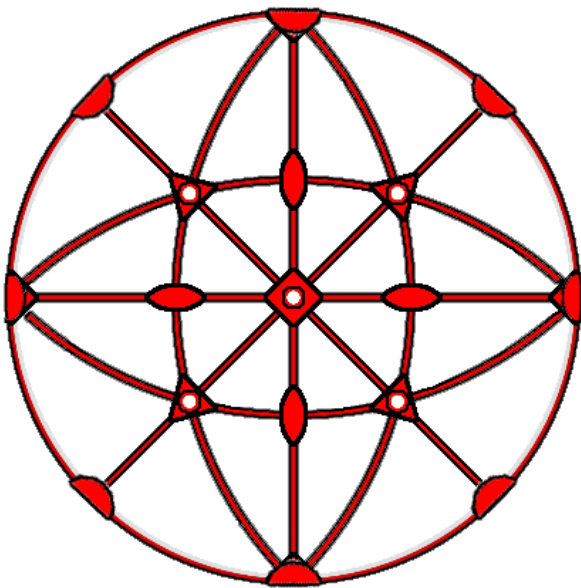

32.1.2.337

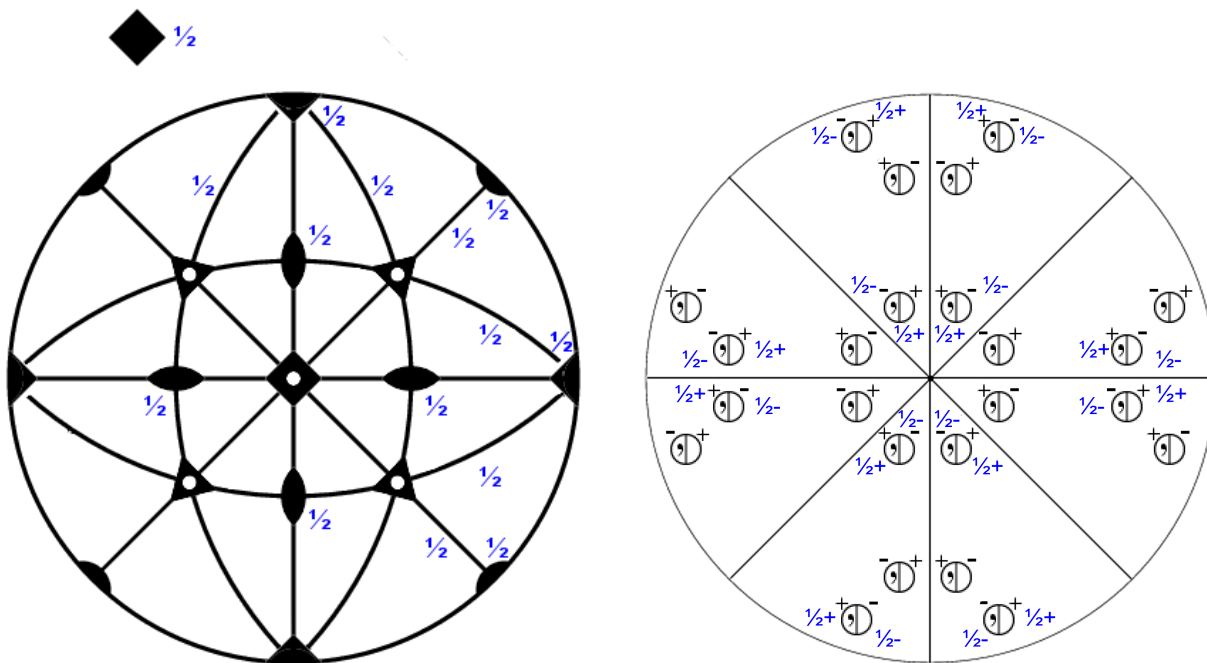

32.2.1.338

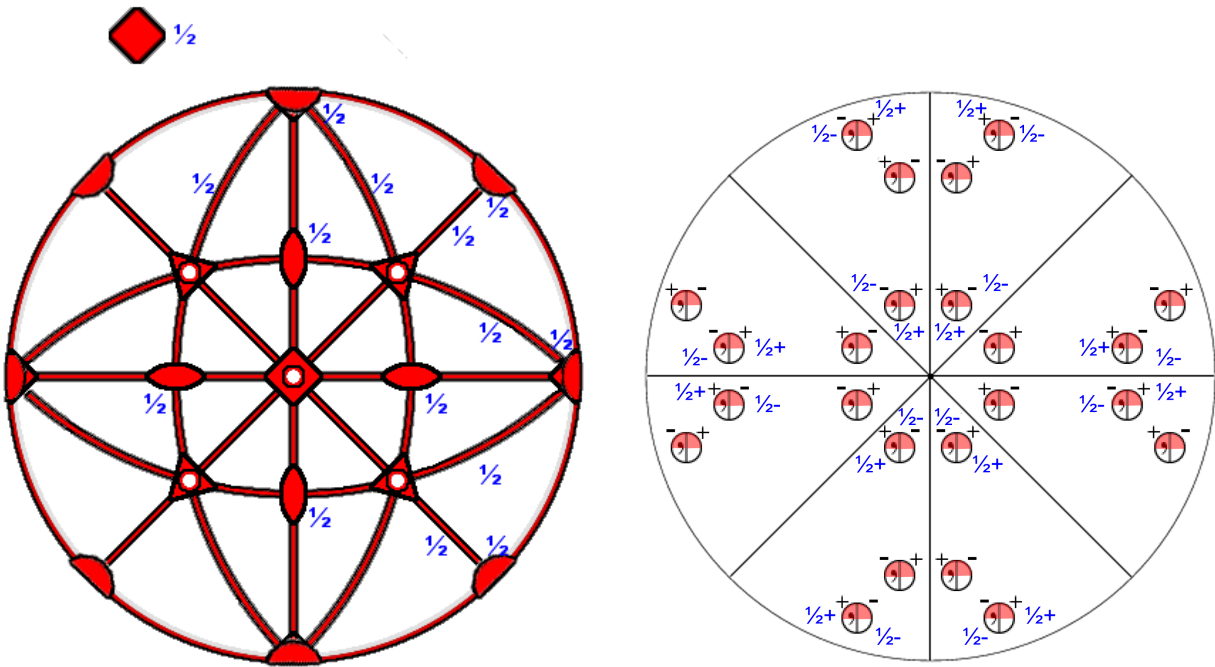

32.2.2.339

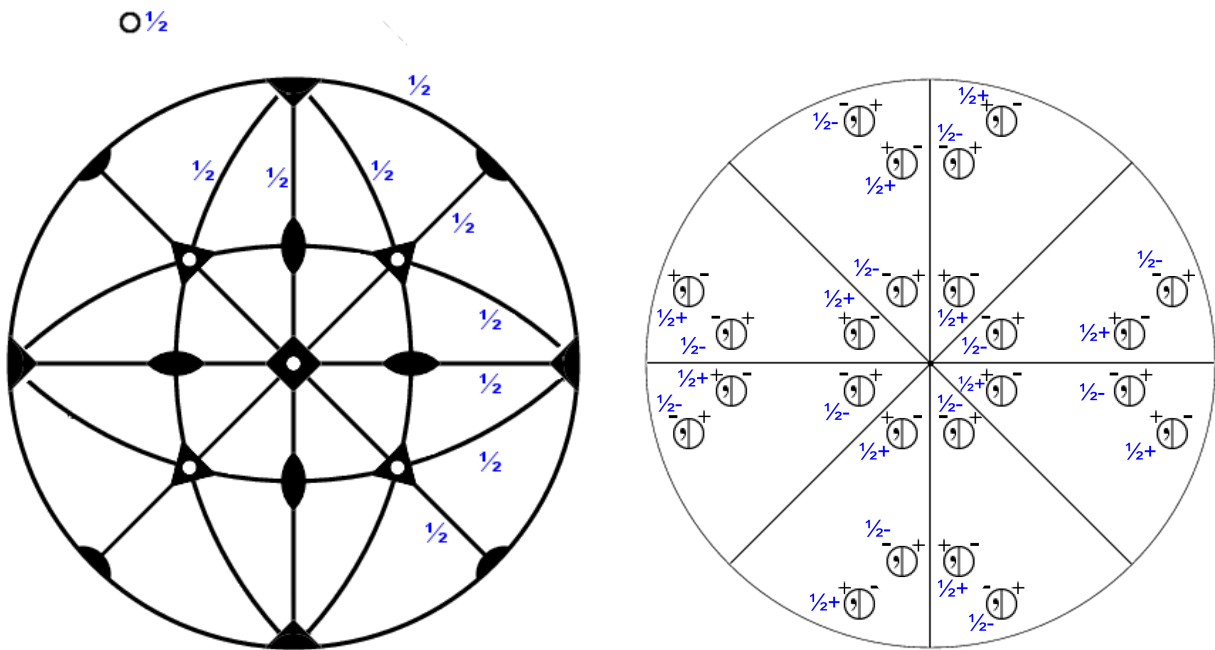

32.3.1.340

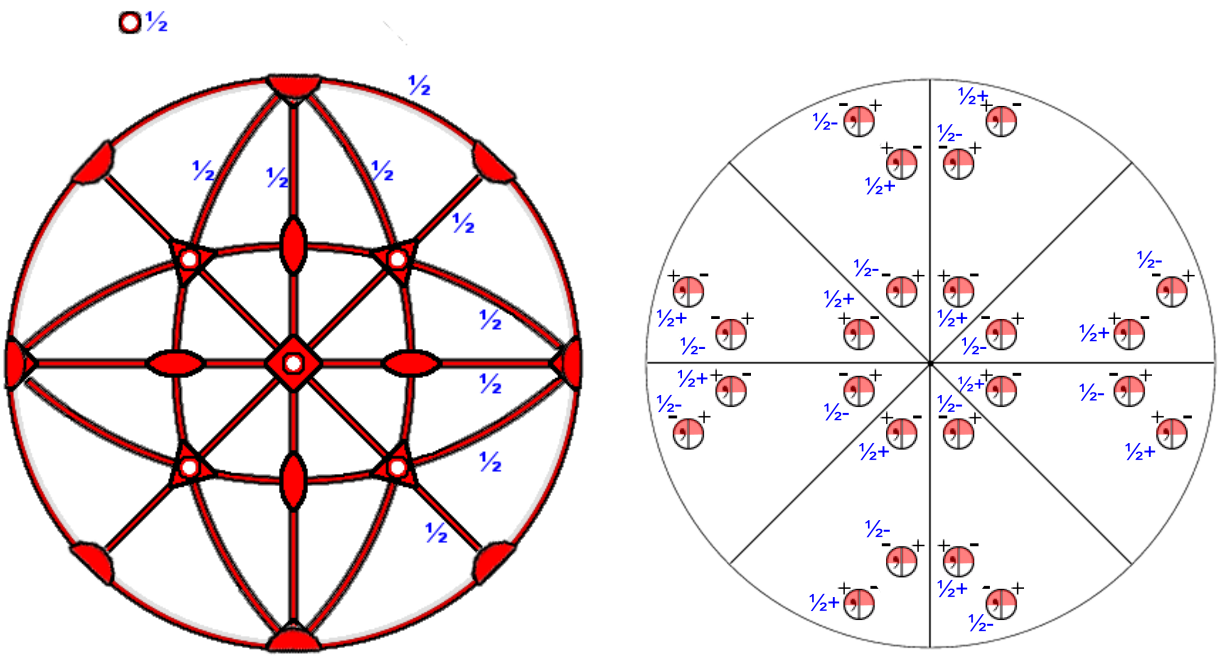

32.3.2.341

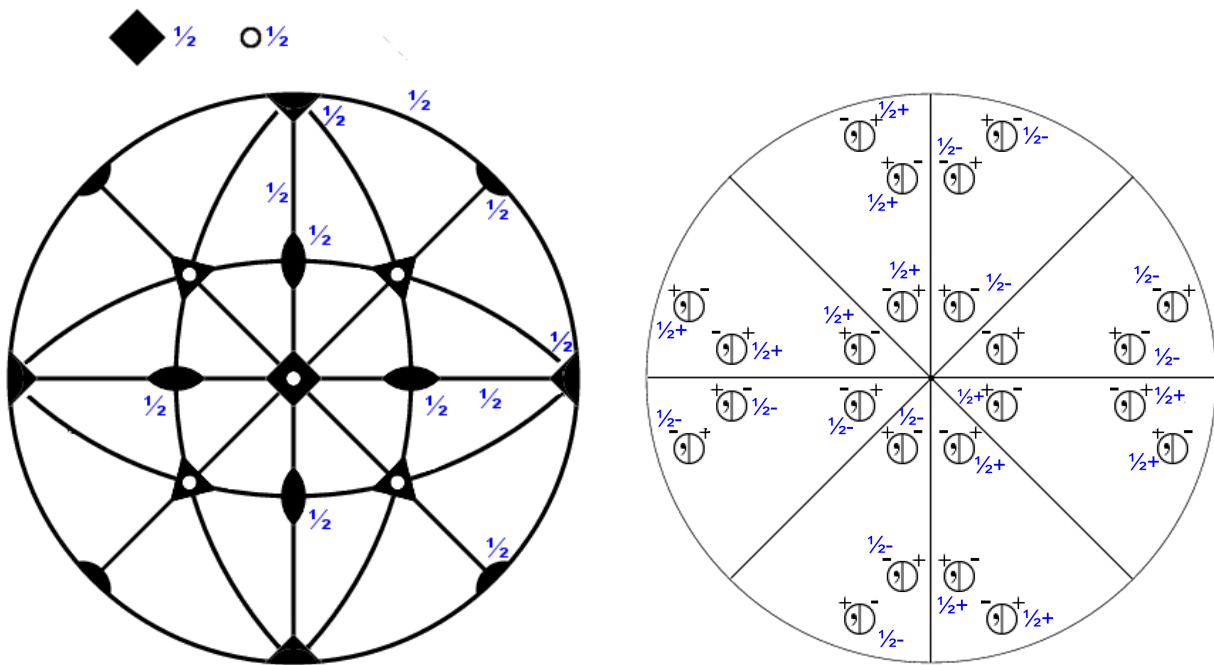

32.4.1.342

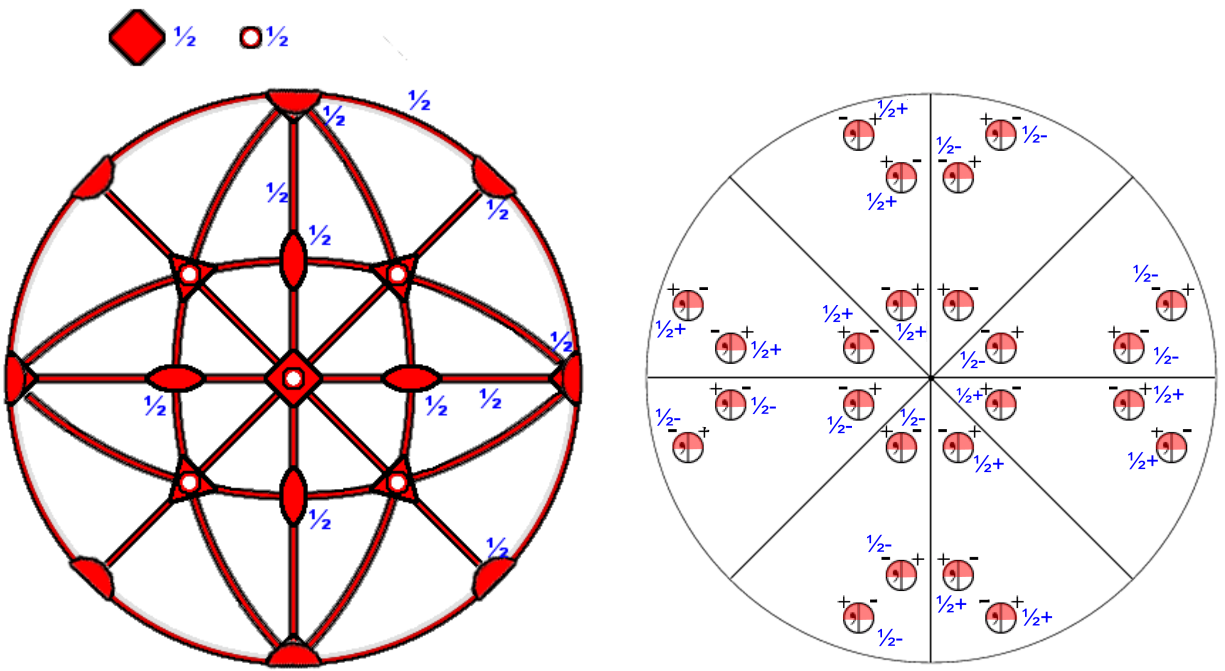

32.4.2.343